



TAI-SAW TECHNOLOGY CO., LTD.

No. 3, Industrial 2nd Rd., Ping-Chen Industrial District,
Taoyuan, 324, Taiwan, R.O.C.

TEL: 886-3-4690038 FAX: 886-3-4697532

E-mail: tstsales@mail.taisaw.com Web: www.taisaw.com

Approval Sheet For Product Specification

Issued Date: 1/3/2007 (REV. NO: 1)

Product Name: SMD 5x7 90MHz Crystal Filter

TST Parts No.: TY0143A

Customer Parts No.: _____

Company: _____
Division: _____
Approved by : _____
Date: _____

Checked by: _____ CC Hsu

Approval by: _____ Robert Chang

Date: _____ 1/3/2007



TAI-SAW TECHNOLOGY CO., LTD.

No. 3, Industrial 2nd Rd., Ping-Chen Industrial District,
Taoyuan, 324, Taiwan, R.O.C.

TEL: 886-3-4690038 FAX: 886-3-4697532

E-mail: tstsales@mail.taisaw.com Web: www.taisaw.com

SMD 5x7 90MHz Crystal Filter

MODEL NO.: TY0143A

REV. NO.: 1

Features:

- Surface Mount Seam Weld Package
- 3-pole IF Filter
- Excellent Reliability Performance

RoHS Compliant
Lead free
Lead-free soldering

Description and Applications:

Surface mount 5.0mmx7.0mm crystal filter for use in wireless telecommunication devices.

Electrical Specifications:

TY0143A	Specification
Center Frequency Fo	90.0 MHz, 3 rd Overtone
Insertion Loss	3.0 dB max
Ripple	1.0 dB max
3 dB Passband	+/-10KHz
Stopband (@+/-15 KHz)	3 dB min
Stopband (@+/-25 KHz)	15 dB min
Stopband (@+/-50 KHz)	30 dB min
Spurious	20 dB min
Terminating Impedance	1500Ω// -1.4pF
Operating Temperature	-20°C ~ +70°C
Marking	Laser marking

Frequency Response:

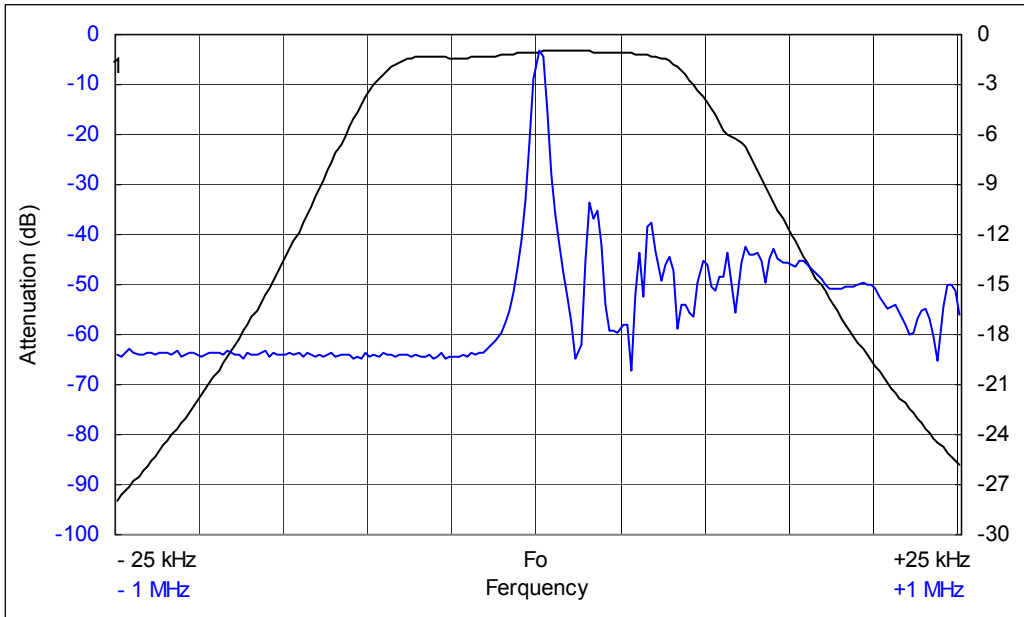

Mechanical Dimensions (mm):

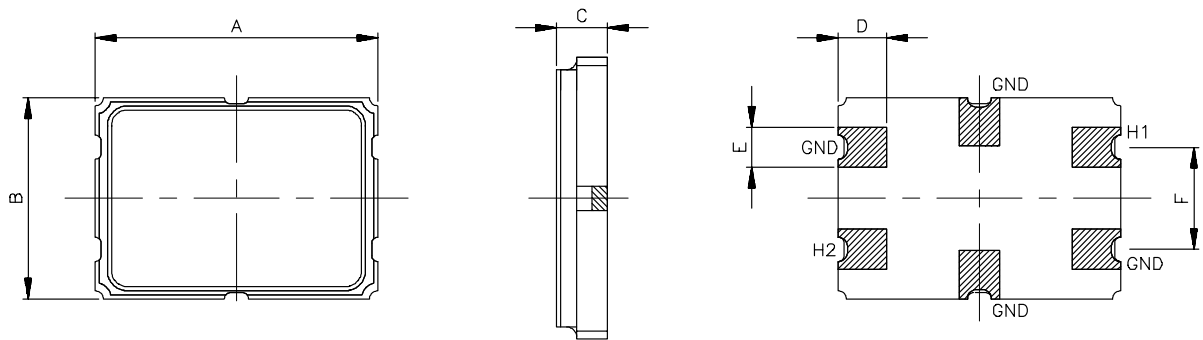

A	B	C	D	E	F
7.00 ±0.18	5.00 ±0.18	1.27 ±0.20	1.21 ±0.13	0.99 ±0.13	2.54 ±0.13

Marking:

Line 1: 90.000 (Customer Frequency)

Line 2: TST Logo + Crystal Filter Product Code + Date Code

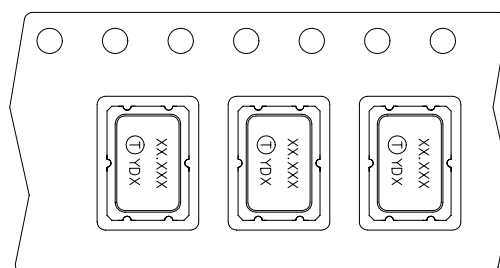
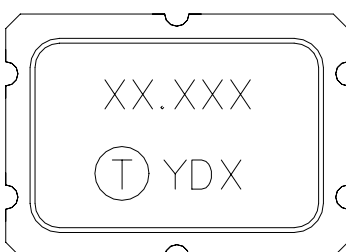

Product Code Table

Year	2001 2005	2002 2006	2003 2007	2004 2008
Product Code	Y	y	<u>Y</u>	<u>y</u>

Date Code Table

WK01	WK02	WK03	WK04	WK05	WK06	WK07	WK08	WK09	WK10	WK11	WK12	WK13
A	B	C	D	E	F	G	H	I	J	K	L	M
WK14	WK15	WK16	WK17	WK18	WK19	WK20	WK21	WK22	WK23	WK24	WK25	WK26
N	O	P	Q	R	S	T	U	V	W	X	Y	Z
WK27	WK28	WK29	WK30	WK31	WK32	WK33	WK34	WK35	WK36	WK37	WK38	WK39
a	b	c	d	e	f	g	h	i	j	k	l	m
WK40	WK41	WK42	WK43	WK44	WK45	WK46	WK47	WK48	WK49	WK50	WK51	WK52
n	o	p	q	r	s	t	u	v	w	x	y	z

Reel Dimensions (mm):

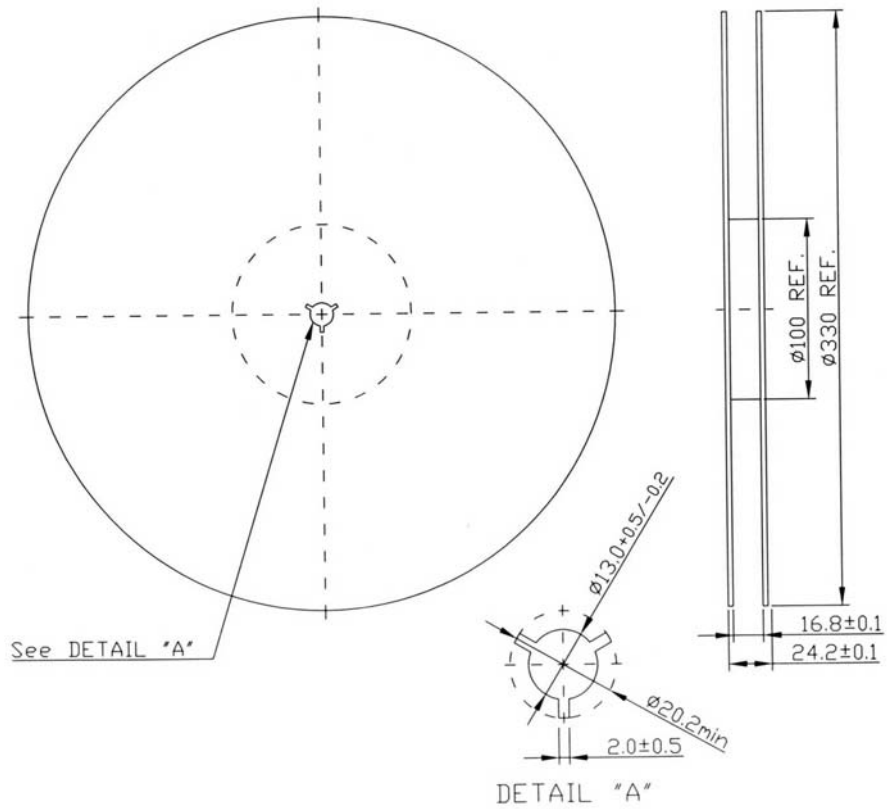

Tape Dimensions (mm):

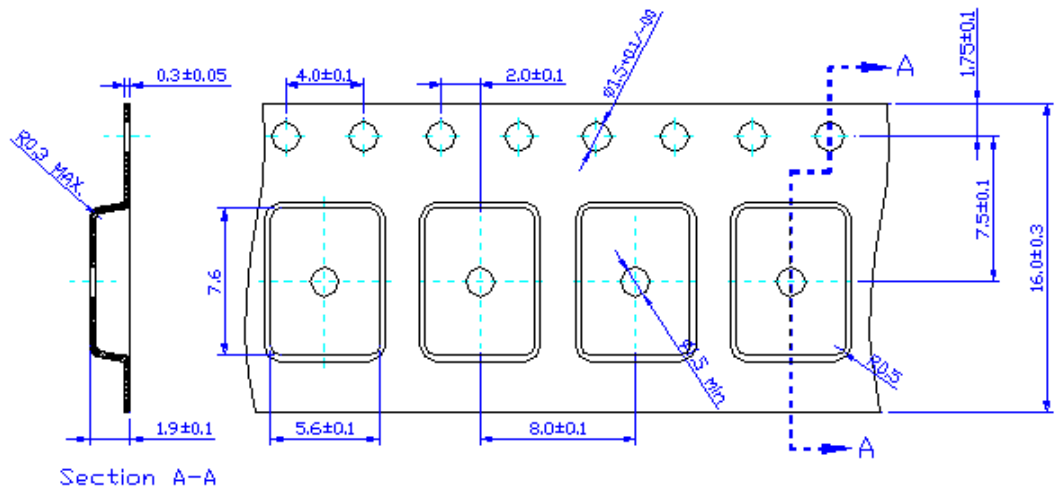

Reflow Profile:

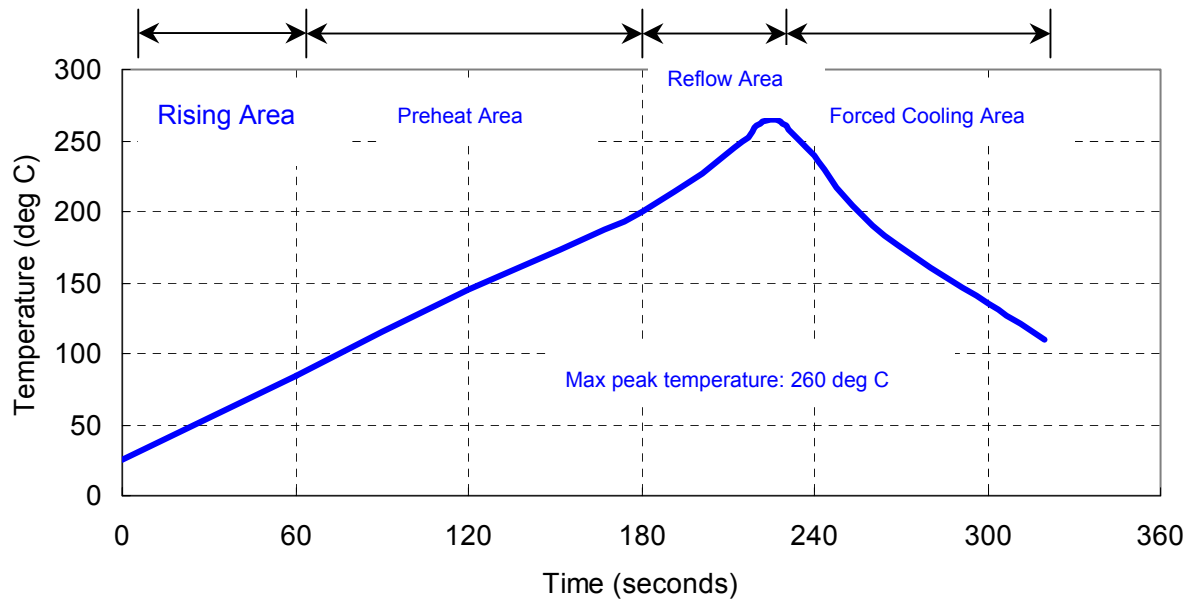

1.