

Domiled[™]

Synonymous with function and performance, the Domiled[™] series is perfectly suited for a variety of cross-industrial applications due to its small package outline, durability and superior brightness.

Features:

- > High brightness surface mount LED.
- > Based on InGaN technology.
- > 120° viewing angle.
- > Small package outline (LxWxH) of 3.2 x 2.8 x 1.8mm.
- > Qualified according to JEDEC moisture sensitivity Level 2.
- > Compatible to IR reflow soldering.
- > Environmental friendly; RoHS compliance.

Applications:

- > Automotive: interior applications, eg: switches, telematics, climate control system, dashboard, etc.
- > Consumer Appliances: LCD illumination as in PDAs, LCD TV.
- > Communication: indicator and backlight in mobilephone.
- > Display: full color display video notice board.
- > Industry: white goods (eg: Oven, microwave, etc.).



Part Ordering Number	Chip Technology / Color	Viewing Angle°	Luminous Intensity @ IF = 20mA IV (mcd)
DDT-CJS-RS2-1	InGaN	120	112.5 - 285.0
• DDT-CJS-R1	True Green, 525nm		112.5 - 140.0
• DDT-CJS-R2			140.0 - 180.0
• DDT-CJS-S1			180.0 - 224.0
• DDT-CJS-S2			224.0 - 285.0
DDT-SJS-ST2-1			180.0 - 450.0
• DDT-SJS-S1			180.0 - 224.0
• DDT-SJS-S2			224.0 - 285.0
• DDT-SJS-T1			285.0 - 355.0
• DDT-SJS-T2			355.0 - 450.0
DDT-UJS-TU2-1			285.0 - 715.0
• DDT-UJS-T1			285.0 - 355.0
• DDT-UJS-T2			355.0 - 450.0
• DDT-UJS-U1			450.0 - 560.0
• DDT-UJS-U2			560.0 - 715.0
DDC-CJS-RS2-1	InGaN	120	112.5 - 285.0
• DDC-CJS-R1	Cyan, 505nm		112.5 - 140.0
• DDC-CJS-R2			140.0 - 180.0
• DDC-CJS-S1			180.0 - 224.0
• DDC-CJS-S2			224.0 - 285.0
DDC-SJS-ST2-1			180.0 - 450.0
• DDC-SJS-S1			180.0 - 224.0
• DDC-SJS-S2			224.0 - 285.0
• DDC-SJS-T1			285.0 - 355.0
• DDC-SJS-T2			355.0 - 450.0
DDC-UJS-TU1-1			285.0 - 560.0
• DDC-UJS-T1			285.0 - 355.0
• DDC-UJS-T2			355.0 - 450.0
• DDC-UJS-U1			450.0 - 560.0
DDB-CJS-PQ2-1	InGaN	120	45.0 - 112.5
• DDB-CJS-P1	Blue, 470nm		45.0 - 56.0
• DDB-CJS-P2			56.0 - 71.5
• DDB-CJS-Q1			71.5 - 90.0
• DDB-CJS-Q2			90.0 - 112.5
DDB-SJS-QR2-1			71.5 - 180.0
• DDB-SJS-Q1			71.5 - 90.0
• DDB-SJS-Q2			90.0 - 112.5
• DDB-SJS-R1			112.5 - 140.0
• DDB-SJS-R2			140.0 - 180.0

Part Ordering Number	Chip Technology / Color	Viewing Angle°	Luminous Intensity @ IF = 20mA IV (mcd)
DDB-UJS-RS1-1	InGaN	120	112.5 - 224.0
• DDB-UJS-R1	Blue, 470nm		112.5 - 140.0
• DDB-UJS-R2			140.0 - 180.0
• DDB-UJS-S1			180.0 - 224.0

NOTE

1. All part number above comes in a quantity of 2000 units per reel.
2. Other luminous intensity groups are also available upon request.
3. Luminous intensity is measured with an accuracy of ± 11%.
4. Wavelength binning is carried for all units as per the wavelength-binning table. Only one wavelength group is allowed for each reel.
5. An optional Vf binning is also available upon request. Binning scheme is as per following table.

Wavelength Grouping

Color	Group	Wavelength distribution (nm)
DDT; True Green	Full	520 - 536
	W	520 - 524
	X	524 - 528
	Y	528 - 532
	Z	532 - 536
DDC; Cyan	Full	499 - 511
	W	499 - 503
	X	503 - 507
	Y	507 - 511
DDB; Blue	Full	464 - 476
	W	464 - 468
	X	468 - 472
	Y	472 - 476

Dominant wavelength is measured with an accuracy of ± 1 nm.

Vf Bining (Optional)

Vf Bin @ 20 mA	Forward Voltage (V)
0A	2.75 ... 3.05
00	3.05 ... 3.35
01	3.35 ... 3.65
02	3.65 ... 3.95
03	3.95 ... 4.25

Forward Voltage, Vf is measured with an accuracy of ± 0.1 V.

Please consult sales and marketing for special part number to incorporate Vf binning.

Electrical Characteristics at Ta=25°C

Part Number	Vf @ If = 20 mA			Vr @ Ir = 10 µA
	Min. (V)	Typ. (V)	Max. (V)	Min. (V)
DDC, DDB	2.9	3.2	3.8	5.0
DDT	2.9	3.4	4.0	5.0

Forward Voltage, Vf is measured with an accuracy of ± 0.1 V.

Absolute Maximum Ratings

	Maximum Value	Unit
DC Forward Current	20	mA
Peak Pulse Current; (tp ≤ 10µs, Duty cycle = 0.005)	DDB = 300 DDC, DDT = 400	mA
Reverse Voltage	5	V
ESD Threshold (HBM)	2	kV
LED Junction Temperature	125	°C
Operating Temperature	-40 ... +100	°C
Storage Temperature	-40 ... +100	°C
Power Dissipation (at room temperature)	85	mW
Thermal Resistance Junction/Solder Point	230	K/W

Relative Intensity Vs Forward Current

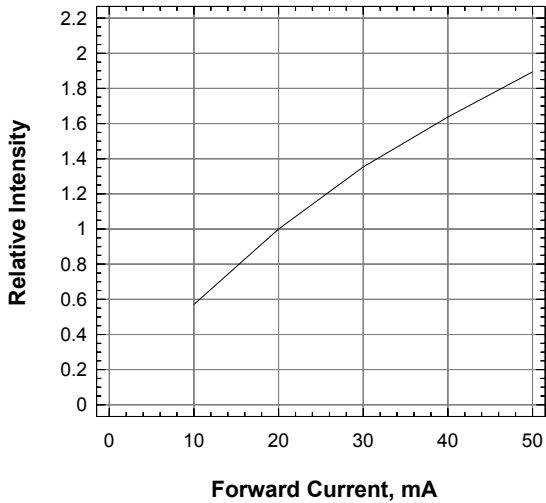

Forward Current Vs Forward Voltage

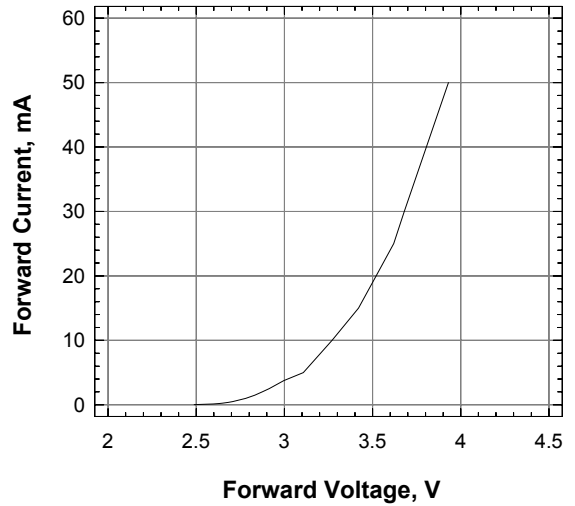

Maximum Current Vs Temperature

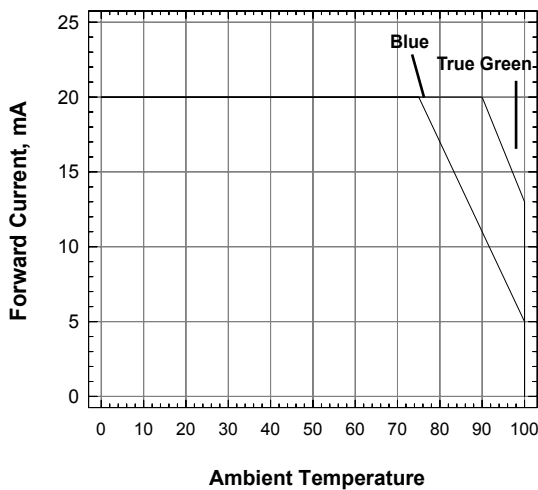

Dominant Wavelength Shift Vs Forward Current

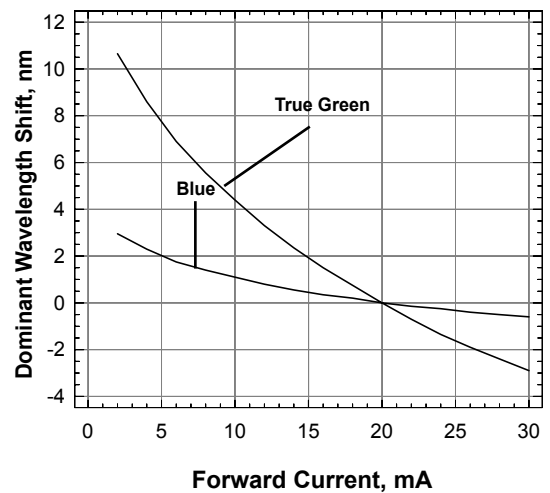

Relative Intensity Vs Wavelength.

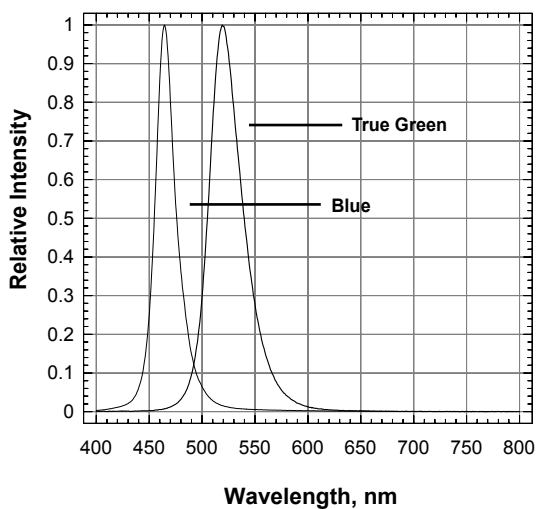

Radiation Pattern

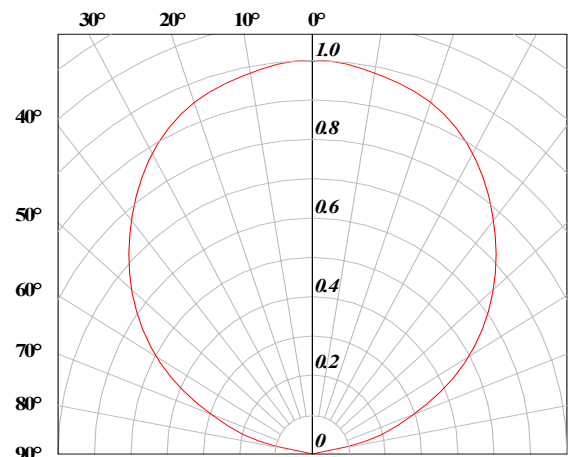

Permissible Pulse Handling Capability
 Duty cycle D = parameter, Ta=25 °C, Blue

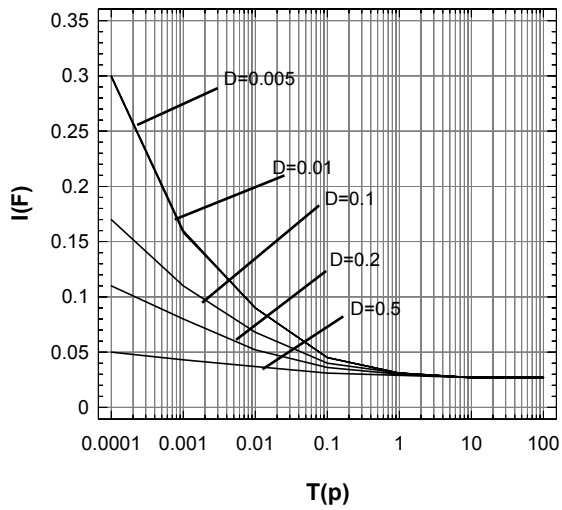

Permissible Pulse Handling Capability
 Duty cycle D = parameter, Ta=25 °C, True Green, Cyan

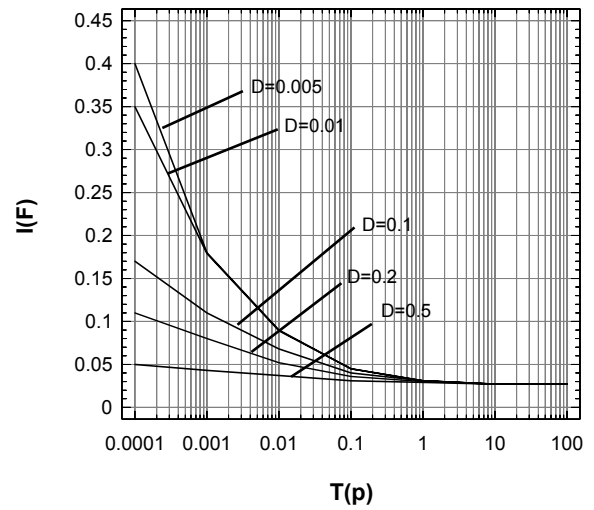

DomiLED™ • InGaN : DDx-xJx Package Outlines

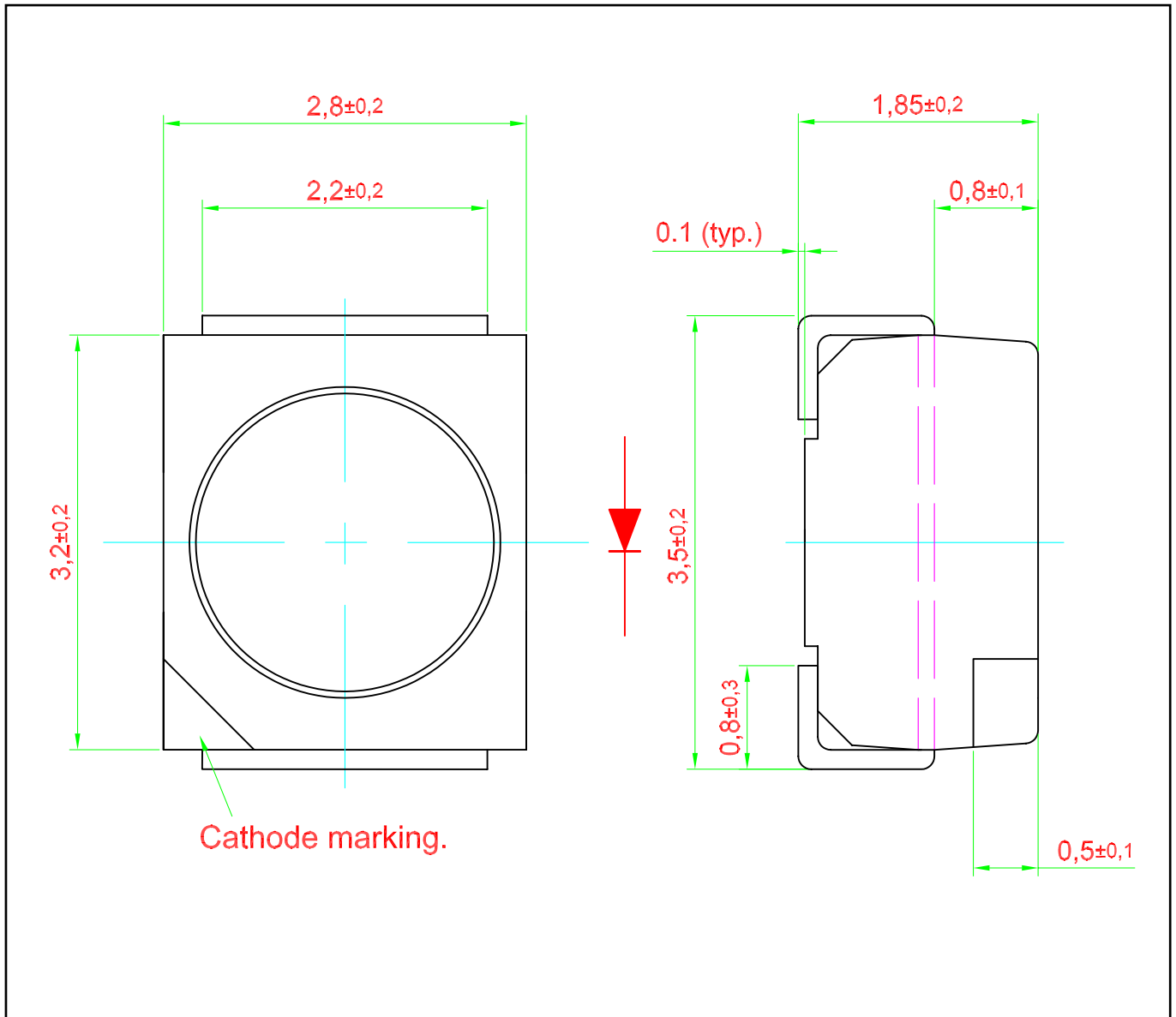

Recommended Solder Pad

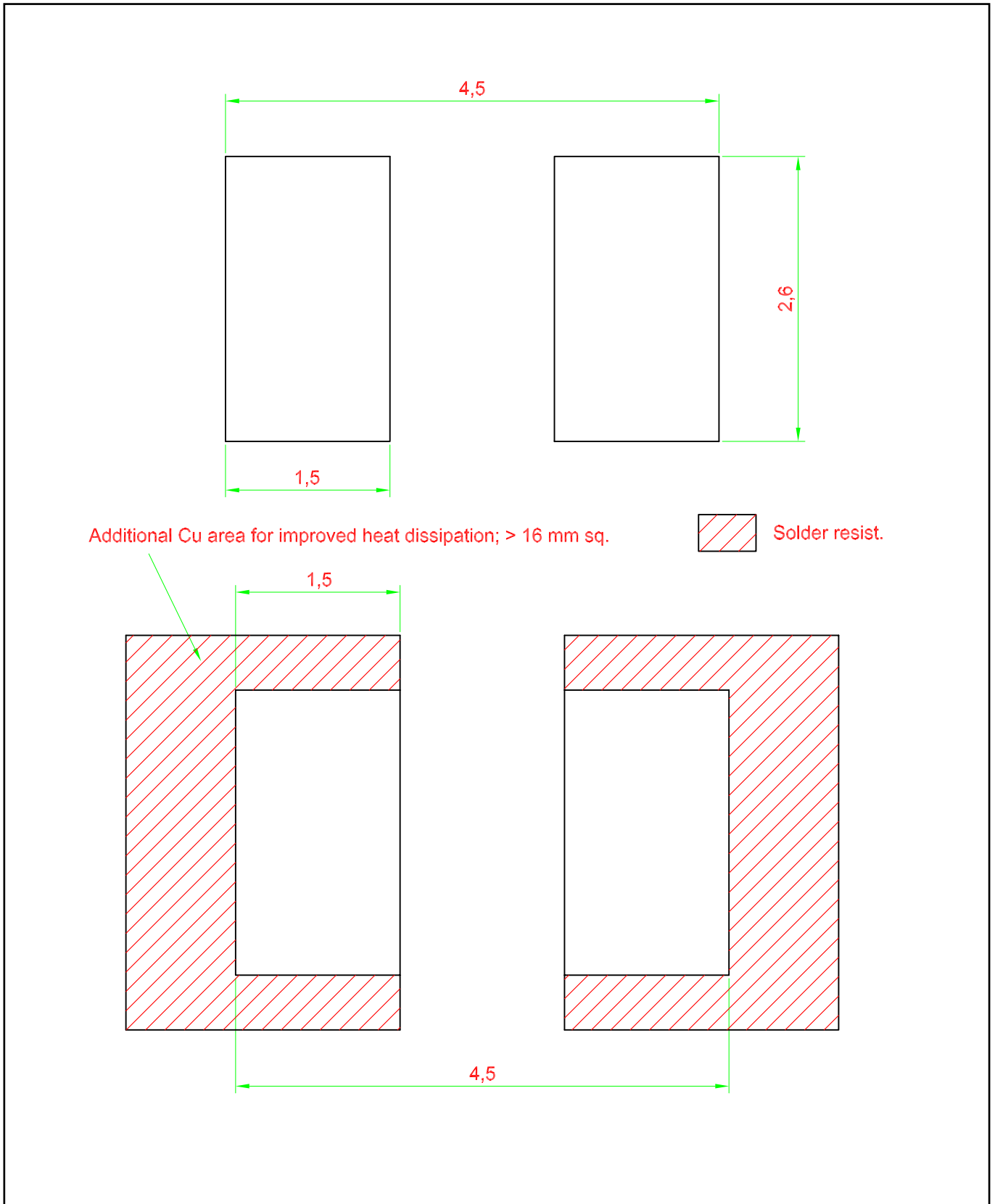

Packaging Specification

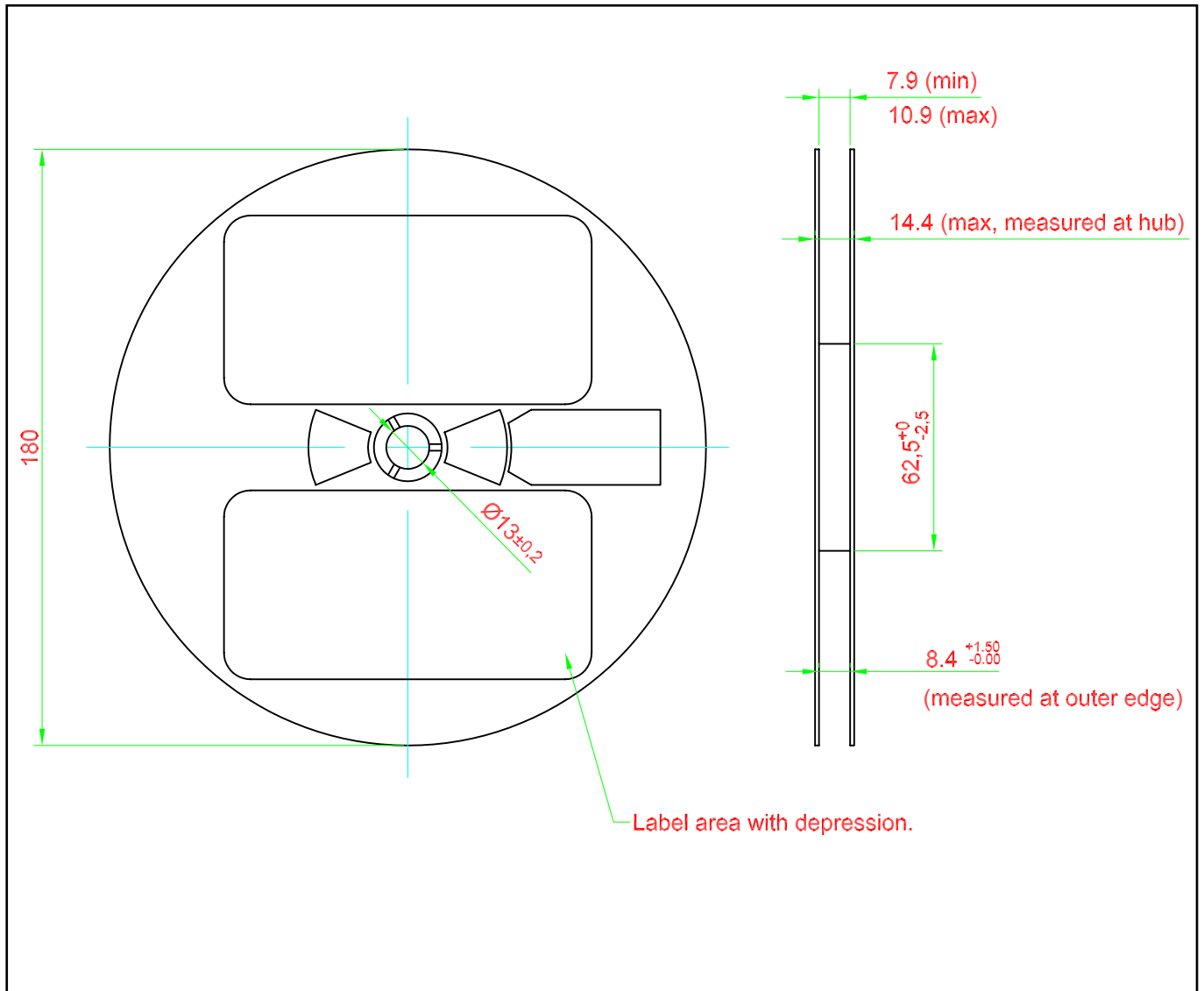

Packaging Specification

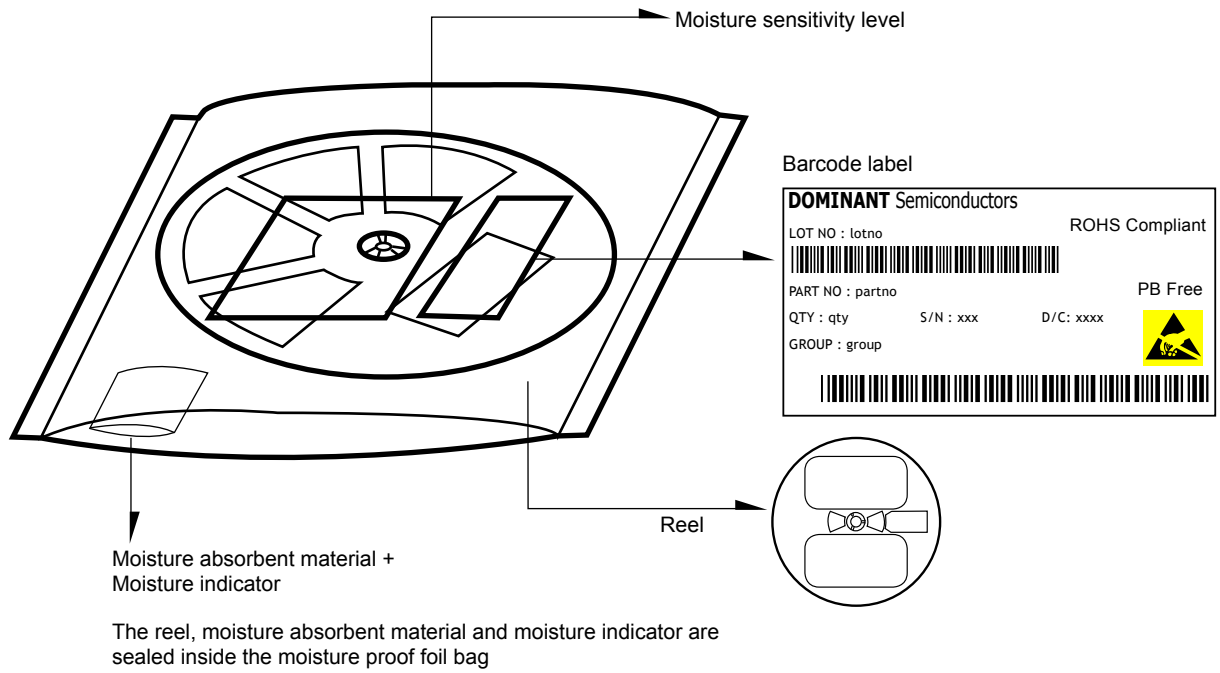

	Average 1pc DomiLED/Multi DomiLED	1 completed bag (2000pcs)
Weight (gram)	0.034	190 ± 10

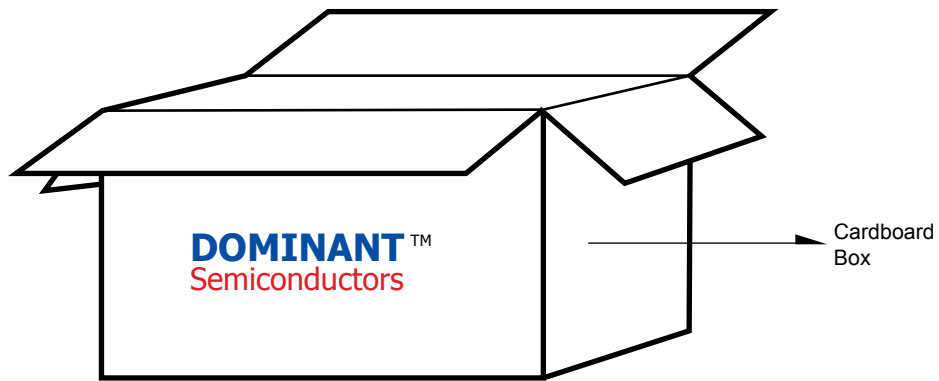

For DomiLED™

Cardboard Box Size	Dimensions (mm)	Empty Box Weight (kg)	Reel / Box	Quantity / Box (pcs)
Small	300 x 250 x 250	0.58	15 reels MAX	30,000 MAX
Large	416 x 516 x 476	1.74	55 reels MAX	110,000 MAX

Recommended Sn-Pb IR-Reflow Soldering Profile

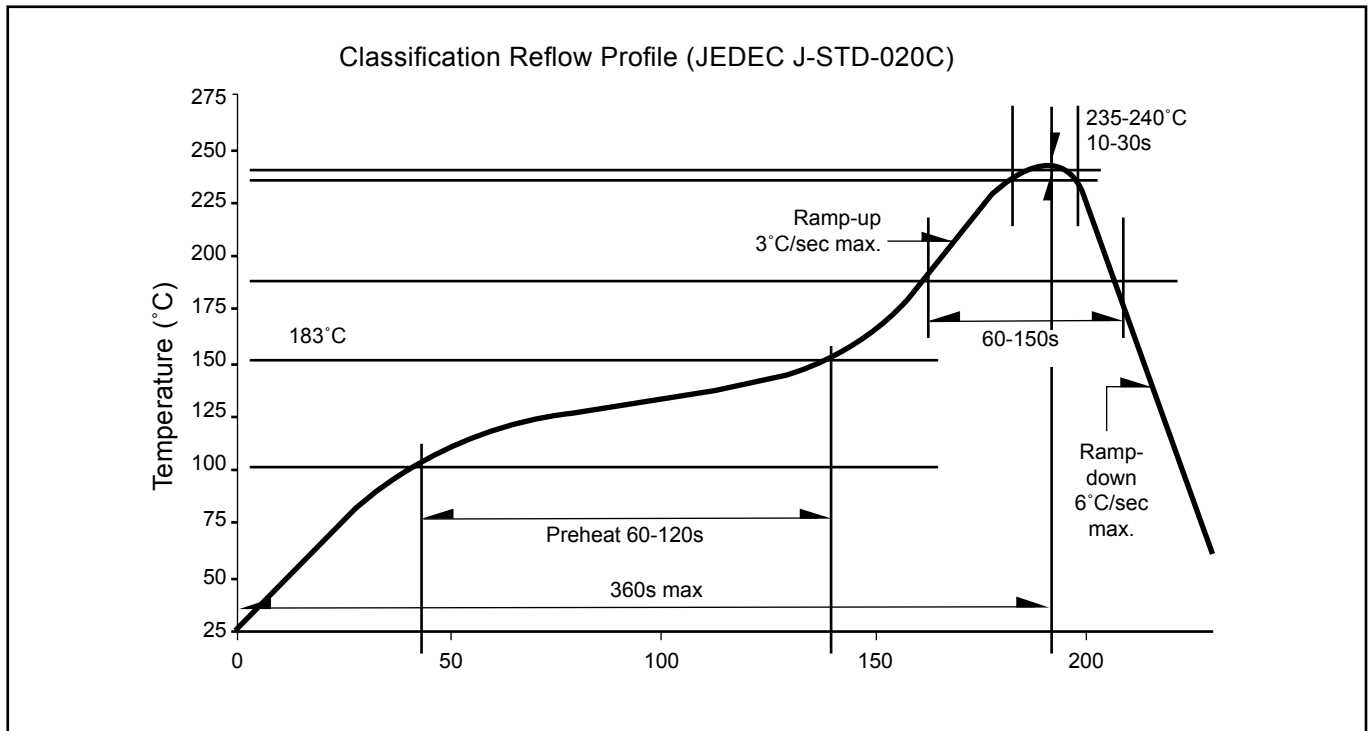

Recommended Pb-free Soldering Profile

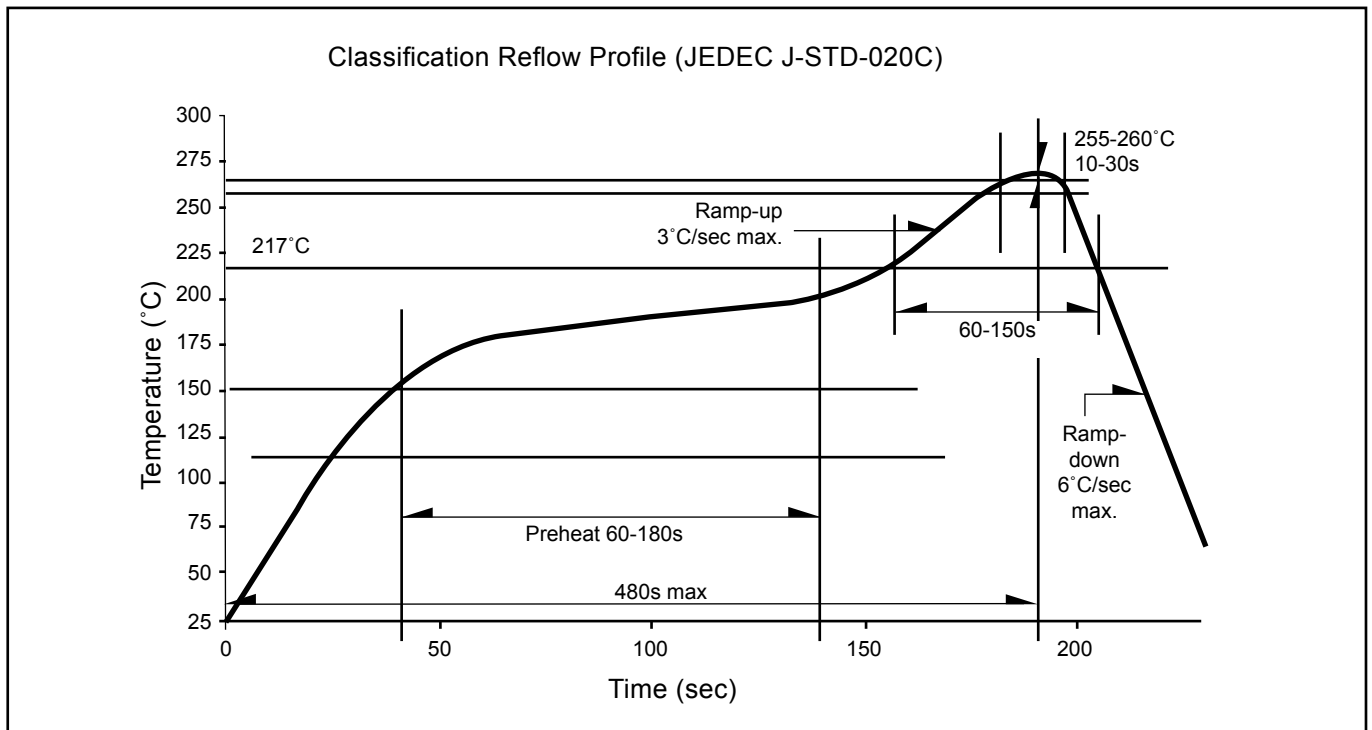

Revision History

Page	Subjects	Date of Modification
-	New Format	06 Sept 2005
5	LED Junction Temperature from 115°C to 125°C	11 Jan 2006
6	Modify Graph: Maximum Current Vs Temperature	11 Jan 2006
5	Add thermal resistance junction/solder point	11 Sep 2006
7	Add Permissible Pulse Handling Capability Graph	11 Sep 2006
4	Take out "Z" grouping for Blue color	07 May 2007

NOTE

All the information contained in this document is considered to be reliable at the time of publishing. However, DOMINANT Semiconductors does not assume any liability arising out of the application or use of any product described herein.

DOMINANT Semiconductors reserves the right to make changes at any time without prior notice to any products in order to improve reliability, function or design.

DOMINANT Semiconductors products are not authorized for use as critical components in life support devices or systems without the express written approval from the Managing Director of DOMINANT Semiconductors.

About Us

DOMINANT Semiconductors is a dynamic Malaysian Corporation that is among the world's leading SMT LED Manufacturers. An excellence – driven organization, it offers a comprehensive product range for diverse industries and applications. Featuring an internationally certified quality assurance acclaim, DOMINANT's extra bright LEDs are perfectly suited for various lighting applications in the automotive, consumer and communications as well as industrial sectors. With extensive industry experience and relentless pursuit of innovation, DOMINANT's state-of-art manufacturing, research and testing capabilities have become a trusted and reliable brand across the globe. More information about DOMINANT Semiconductors can be found on the Internet at <http://www.dominant-semi.com>.

Please contact us for more information:

Head Quarter

DOMINANT Semiconductors Sdn. Bhd.
Lot 6, Batu Berendam, FTZ Phase III, 75350 Melaka, Malaysia
Tel: (606) 283 3566 Fax: (606) 283 0566
E-mail: sales@dominant-semi.com

DOMINANT China Sales Office

DOMINANT Semiconductors (Shenzhen) Co. Ltd.
24BC Newbaohui Building, No. 1007 West Nanhai Blvd., Nanshan, Shenzhen, China P.C. 518054
Tel: +86 (755) 86031785 / +86 (755) 86031786 Fax: +86 (755) 86031789
E-mail: sales_china@dominant-semi.com

DOMINANT Korea Sales Office

DOMINANT Semiconductors Korea Inc.
902 Sunil Technopia, 440 Sangdaewon-dong, Jungwon-gu, Sungnam-si, Kyunggi-do, Korea 462726
Tel: 82-31-777-3978 Fax: 82-31-777-3976
E-mail: sales_korea@dominant-semi.com

