

Features

- Specified for + 3V, + 5V, or ± 5V Applications
- Power Down to 0 μA (EL2157C)
- Output Voltage Clamp (EL2157C)
- Large Input Common Mode Range $0V < V_{CM} < V_s - 1.2V$
- Output Swings to Ground Without Saturating
- -3 dB Bandwidth = 125 MHz
- ± 0.1 dB Bandwidth = 30 MHz
- Low Supply Current = 5 mA
- Slew Rate = 275V/μs
- Low Offset Voltage = 2 mV max (PDIP and SO Packages)
- Output Current = ±100 mA
- High Open Loop Gain = 80 dB
- Differential Gain = 0.05%
- Differential Phase = 0.05°

Applications

- Video Amplifier
- PCMCIA Applications
- A/D Driver
- Line Driver
- Portable Computers
- High Speed Communications
- RGB Applications
- Broadcast Equipment
- Active Filtering

Ordering Information

Part No.	Temp. Range	Package	Outline #
EL2150CN	-40°C to +85°C	8 Pin PDIP	MDP0031
EL2150CS	-40°C to +85°C	8 Pin SOIC	MDP0027
EL2150CW	-40°C to +85°C	5 Pin SOT23*	MDP0038
EL2157CN	-40°C to +85°C	8 Pin PDIP	MDP0031
EL2157CS	-40°C to +85°C	8 Pin SOIC	MDP0027

*See Ordering Information section of databook.

General Description

The EL2150C/EL2157C are the electronics industry's fastest single supply op amps available. Prior single supply op amps have generally been limited to bandwidths and slew rates 1/4 that of the EL2150C/EL2157C. The 125 MHz bandwidth, 275 V/μs slew rate, and 0.05%/0.05° differential gain/differential phase makes this part ideal for single or dual supply video speed applications. With its voltage feedback architecture, this amplifier can accept reactive feedback networks, allowing them to be used in analog filtering applications. The inputs can sense signals below the bottom supply rail and as high as 1.2V below the top rail. Connecting the load resistor to ground and operating from a single supply, the outputs swing completely to ground without saturating. The outputs can also drive to within 1.2V of the top rail. The EL2150C/EL2157C will output ±100 mA and will operate with single supply voltages as low as 2.7V, making it ideal for portable, low power applications.

The EL2157C has a high speed disable feature. Applying a low logic level to this pin reduces the supply current to 0 μA within 50 ns. This is useful for both multiplexing and reducing power consumption.

The EL2157C also has an output voltage clamp feature. This clamp is a fast recovery (<7 ns) output clamp that prevents the output voltage from going above the preset clamp voltage. This feature is desirable for A/D applications, as A/D converters can require long times to recover if overdriven.

For applications where board space is critical the EL2150C is available in the tiny 5 lead SOT23 package, which has a footprint 28% the size of an 8 lead SOIC. The EL2150C/EL2157C are also both available in 8 pin plastic DIP and SOIC packages. All parts operate over the industrial temperature range of -40°C to +85°C. For dual, triple, or quad applications, contact the factory.

Connection Diagrams

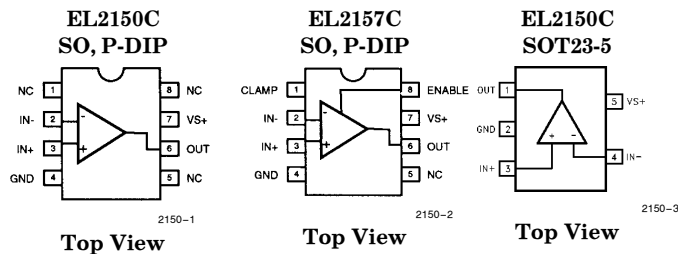

Note: All information contained in this data sheet has been carefully checked and is believed to be accurate as of the date of publication; however, this data sheet cannot be a "controlled document". Current revisions, if any, to these specifications are maintained at the factory and are available upon your request. We recommend checking the revision level before finalization of your design documentation.

EL2150C/EL2157C

125 MHz Single Supply, Clamping Op Amps

Absolute Maximum Ratings ($T_A = 25^\circ\text{C}$)

Supply Voltage between V_{S+} and GND	+12.6V	Power Dissipation	See Curves
Input Voltage ($IN+$, $IN-$, ENABLE, CLAMP)	GND–0.3V, $V_S + 0.3V$	Storage Temperature Range	–65°C to +150°C
Differential Input Voltage	±6V	Ambient Operating Temperature Range	–40°C to +85°C
Maximum Output Current	90 mA	Operating Junction Temperature	150°C
Output Short Circuit Duration	(note 1)		

Important Note:

All parameters having Min/Max specifications are guaranteed. The Test Level column indicates the specific device testing actually performed during production and Quality inspection. Elantec performs most electrical tests using modern high-speed automatic test equipment, specifically the LTX77 Series system. Unless otherwise noted, all tests are pulsed tests, therefore $T_J = T_C = T_A$.

Test Level	Test Procedure
I	100% production tested and QA sample tested per QA test plan QCX0002.
II	100% production tested at $T_A = 25^\circ\text{C}$ and QA sample tested at $T_A = 25^\circ\text{C}$, T_{MAX} and T_{MIN} per QA test plan QCX0002.
III	QA sample tested per QA test plan QCX0002.
IV	Parameter is guaranteed (but not tested) by Design and Characterization Data.
V	Parameter is typical value at $T_A = 25^\circ\text{C}$ for information purposes only.

DC Electrical Characteristics

(Note 2) $V_S = +5V$, $GND = 0V$, $T_A = 25^\circ\text{C}$, $V_{CM} = 1.5V$, $V_{OUT} = 1.5V$, $V_{CLAMP} = +5V$, $V_{ENABLE} = +5V$, unless otherwise specified.

Parameter	Description	Conditions	Min	Typ	Max	Test Level	Units
V_{OS}	Offset Voltage	PDIP and SOIC Packages	–2		2	I	mV
		SOT23-5 Package	–3		3	I	mV
TCV_{OS}	Offset Voltage Temperature Coefficient	Measured from T_{min} to T_{max}		10		V	$\mu\text{V}/^\circ\text{C}$
I_B	Input Bias Current	$V_{IN} = 0V$		–5.5	–10	I	μA
I_{OS}	Input Offset Current	$V_{IN} = 0V$	–750	150	750	I	nA
TCI_{OS}	Input Bias Current Temperature Coefficient	Measured from T_{min} to T_{max}		50		V	$\text{nA}/^\circ\text{C}$
PSRR	Power Supply Rejection Ratio	$V_S = V_{ENABLE} = +2.7V$ to +12V, $V_{CLAMP} = \text{OPEN}$	55	70		I	dB
CMRR	Common Mode Rejection Ratio	$V_{CM} = 0V$ to +3.8V	55	65		I	dB
		$V_{CM} = 0V$ to +3.0V	55	70		I	dB
CMIR	Common Mode Input Range		0		$V_S - 1.2$	I	V
R_{IN}	Input Resistance	Common Mode	1	2		I	$\text{M}\Omega$
C_{IN}	Input Capacitance	SOIC Package		1		V	pF
		PDIP Package		1.5		V	pF
R_{OUT}	Output Resistance	$A_v = +1$		40		V	$\text{m}\Omega$
$I_{S,ON}$	Supply Current—Enabled	$V_S = V_{CLAMP} = +12V$, $V_{ENABLE} = +12V$		5	6.5	I	mA
$I_{S,OFF}$	Supply Current—Shut Down	$V_S = V_{CLAMP} = +10V$, $V_{ENABLE} = +0.5V$		0	50	I	μA
		$V_S = V_{CLAMP} = +12V$, $V_{ENABLE} = +0.5V$		5		V	μA
PSOR	Power Supply Operating Range		2.7		12.0	I	v

EL2150C/EL2157C

125 MHz Single Supply, Clamping Op Amps

DC Electrical Characteristics — Contd.

(Note 2) $V_S = +5V$, $GND = 0V$, $T_A = 25^\circ C$, $V_{CM} = +1.5V$, $V_{OUT} = +1.5V$, $V_{CLAMP} = +5V$, $V_{ENABLE} = +5V$, unless otherwise specified

Parameter	Description	Conditions	Min	Typ	Max	Test Level	Units
PSOR	Power Supply Operating Range		2.7		12.0	I	V
AVOL	Open Loop Gain	$V_S = V_{CLAMP} = +12V$, $V_{OUT} = +2V$ to $+9V$, $R_L = 1\text{ k}\Omega$ to GND	65	80		I	dB
		$V_{OUT} = +1.5V$ to $+3.5V$, $R_L = 1\text{ k}\Omega$ to GND		70		V	dB
		$V_{OUT} = +1.5V$ to $+3.5V$, $R_L = 150\Omega$ to GND		60		V	dB
V _{OP}	Positive Output Voltage Swing	$V_S = +12V$, $A_V = +1$, $R_L = 1\text{ k}\Omega$ to 0V		10.8		V	V
		$V_S = +12V$, $A_V = +1$, $R_L = 150\Omega$ to 0V	9.6	10.0		I	V
		$V_S = \pm 5V$, $A_V = +1$, $R_L = 1\text{ k}\Omega$ to 0V		4.0		V	V
		$V_S = \pm 5V$, $A_V = +1$, $R_L = 150\Omega$ to 0V	3.4	3.8		I	V
		$V_S = +3V$, $A_V = +1$, $R_L = 150\Omega$ to 0V	1.8	1.95		I	V
V _{ON}	Negative Output Voltage Swing	$V_S = +12V$, $A_V = +1$, $R_L = 150\Omega$ to 0V		5.5	8	I	mV
		$V_S = \pm 5V$, $A_V = +1$, $R_L = 1\text{ k}\Omega$ to 0V		-4.0		V	V
		$V_S = \pm 5V$, $A_V = +1$, $R_L = 150\Omega$ to 0V		-3.7	-3.4	I	V
I _{OUT}	Output Current (Note 1)	$V_S = \pm 5V$, $A_V = +1$, $R_L = 10\Omega$ to 0V	± 75	± 100		I	mA
		$V_S = \pm 5V$, $A_V = +1$, $R_L = 50\Omega$ to 0V		± 60		V	mA
I _{OUT,OFF}	Output Current, Disabled	$V_{ENABLE} = +0.5V$		0	20	I	μA
V _{IH-EN}	ENABLE pin Voltage for Power Up	Relative to GND pin	2.0			I	V
V _{IL-EN}	ENABLE pin Voltage for Shut Down	Relative to GND pin			0.5	I	V
I _{IH-EN}	ENABLE pin Input Current-High (Note 3)	$V_S = V_{CLAMP} = +12V$, $V_{ENABLE} = +12V$		340	410	I	μA
I _{IL-EN}	ENABLE pin Input Current-Low (Note 3)	$V_S = V_{CLAMP} = +12V$, $V_{ENABLE} = +0.5V$		0	1	I	μA
V _{OR-CL}	Voltage Clamp Operating Range (Note 4)	Relative to GND pin	1.2		V _{OP}	I	V
V _{ACC-CL}	CLAMP Accuracy (Note 5)	$V_{IN} = +4V$, $R_L = 1\text{ k}\Omega$ to GND $V_{CLAMP} = +1.5V$ and $+3.5V$	-250	100	250	I	mV
I _{IH-CL}	CLAMP pin Input Current—High	$V_S = V_{CLAMP} = +12V$		12	25	I	μA
I _{IL-CL}	CLAMP pin Input Current—Low	$V_S = +12V$, $V_{CLAMP} = +1.2V$	-20	-15		I	μA

EL2150C/EL2157C

125 MHz Single Supply, Clamping Op Amps

Closed Loop AC Electrical Characteristics

(Notes 2 & 6) $V_S = +5V$, $GND = 0V$, $T_A = 25^\circ C$, $V_{CM} = +1.5V$, $V_{OUT} = +1.5V$, $V_{CLAMP} = +5V$, $V_{ENABLE} = +5V$, $A_V = +1$, $R_F = 0\Omega$, $R_L = 150\Omega$ to GND pin, unless otherwise specified

Parameter	Description	Conditions	Min	Typ	Max	Test Level	Units
BW	-3 dB Bandwidth ($V_{OUT} = 400$ mVp-p)	$V_S = +5V$, $A_V = +1$, $R_F = 0\Omega$		125		V	MHz
		$V_S = +5V$, $A_V = -1$, $R_F = 500\Omega$		60		V	MHz
		$V_S = +5V$, $A_V = +2$, $R_F = 500\Omega$		60		V	MHz
		$V_S = +5V$, $A_V = +10$, $R_F = 500\Omega$		6		V	MHz
		$V_S = +12V$, $A_V = +1$, $R_F = 0\Omega$		150		V	MHz
		$V_S = +3V$, $A_V = +1$, $R_F = 0\Omega$		100		V	MHz
BW	± 0.1 dB Bandwidth ($V_{OUT} = 400$ mVp-p)	$V_S = +12V$, $A_V = +1$, $R_F = 0\Omega$		25		V	MHz
		$V_S = +5V$, $A_V = +1$, $R_F = 0\Omega$		30		V	MHz
		$V_S = +3V$, $A_V = +1$, $R_F = 0\Omega$		20		V	MHz
GBWP	Gain Bandwidth Product	$V_S = +12V$, @ $A_V = +10$		60		V	MHz
PM	Phase Margin	$R_L = 1$ k Ω , $CL = 6$ pF		55		V	°
SR	Slew Rate	$V_S = +10V$, $R_L = 150\Omega$, $V_{out} = 0V$ to $+6V$	200	275		I	V/ μs
		$V_S = +5V$, $R_L = 150\Omega$, $V_{OUT} = 0V$ to $+3V$		300		V	V/ μs
t_R, t_F	Rise Time, Fall Time	$\pm 0.1V$ step		2.8		V	ns
OS	Overshoot	$\pm 0.1V$ step		10		V	%
t_{PD}	Propagation Delay	$\pm 0.1V$ step		3.2		V	ns
t_S	0.1% Settling Time	$V_S = \pm 5V$, $R_L = 500\Omega$, $A_V = +1$, $V_{OUT} = \pm 3V$		40		V	ns
	0.01% Settling Time	$V_S = \pm 5V$, $R_L = 500\Omega$, $A_V = +1$, $V_{OUT} = \pm 3V$		75		V	ns
dG	Differential Gain (Note 7)	$A_V = +2$, $R_F = 1$ k Ω		0.05		V	%
dP	Differential Phase (Note 7)	$A_V = +2$, $R_F = 1$ k Ω		0.05		V	°
e_N	Input Noise Voltage	$f = 10$ kHz		48		V	nV \sqrt{Hz}
i_N	Input Noise Current	$f = 10$ kHz		1.25		V	pA \sqrt{Hz}
t_{DIS}	Disable Time (Note 8)			50		V	ns
t_{EN}	Enable Time (Note 8)			25		V	ns
t_{CL}	Clamp Overload Recovery			7		V	ns

Note 1: Internal short circuit protection circuitry has been built into the EL2150C/EL2157C. See the Applications section.

Note 2: CLAMP pin and ENABLE pin specifications apply only to the EL2157C.

Note 3: If the disable feature is not desired, tie the ENABLE pin to the V_S pin, or apply a logic high level to the ENABLE pin.

Note 4: The maximum output voltage that can be clamped is limited to the maximum positive output Voltage, or V_{OP} . Applying a Voltage higher than V_{OP} inactivates the clamp. If the clamp feature is not desired, either tie the CLAMP pin to the V_S pin, or simply let the CLAMP pin float.

Note 5: The clamp accuracy is affected by V_{IN} and R_L . See the Typical Curves Section and the Clamp Accuracy vs. V_{IN} & R_L curve.

Note 6: All AC tests are performed on a "warmed up" part, except slew rate, which is pulse tested.

Note 7: Standard NTSC signal = 286 mVp-p, $f = 3.58$ MHz, as V_{IN} is swept from 0.6V to 1.314V. R_L is DC coupled.

Note 8: Disable/Enable time is defined as the time from when the logic signal is applied to the ENABLE pin to when the supply current has reached half its final value.

EL2150C/EL2157C

125 MHz Single Supply, Clamping Op Amps

Typical Performance Curves

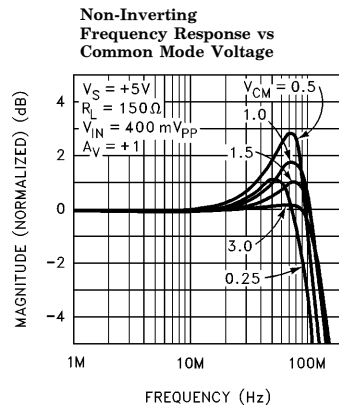
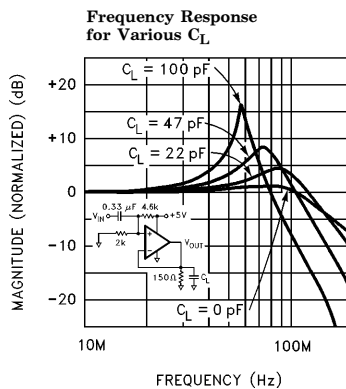
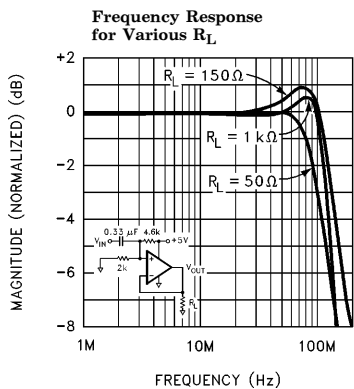
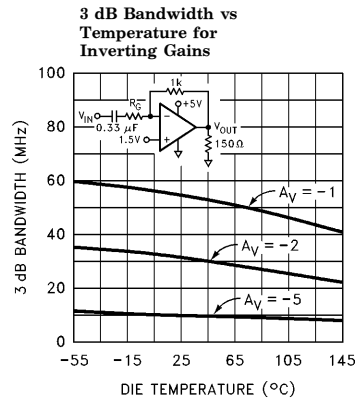
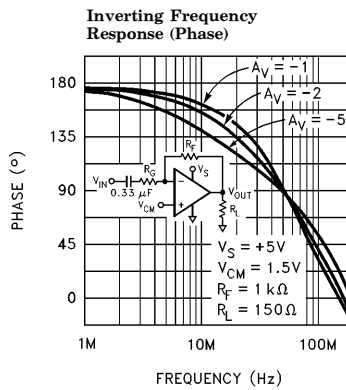
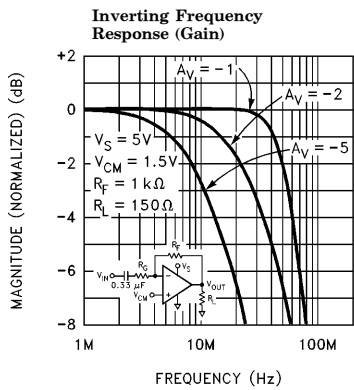
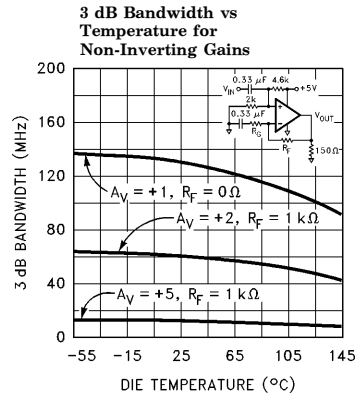
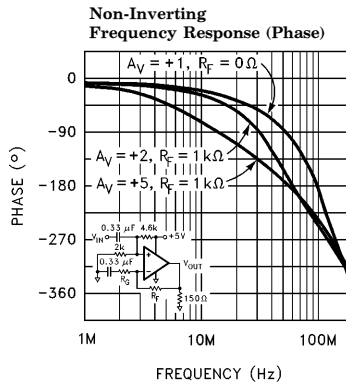
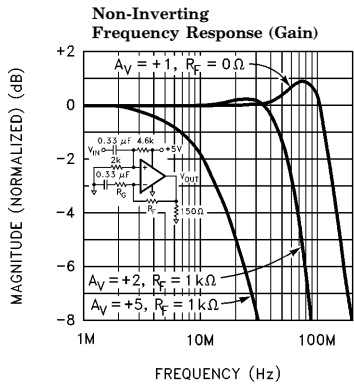

2150-74

EL2150C/EL2157C

125 MHz Single Supply, Clamping Op Amps

Typical Performance Curves — Contd.

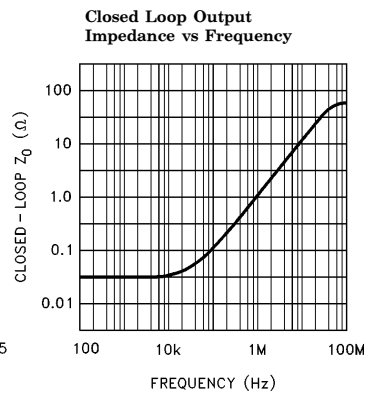
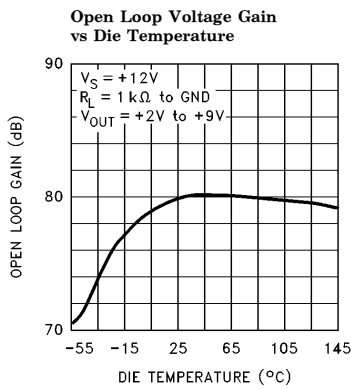
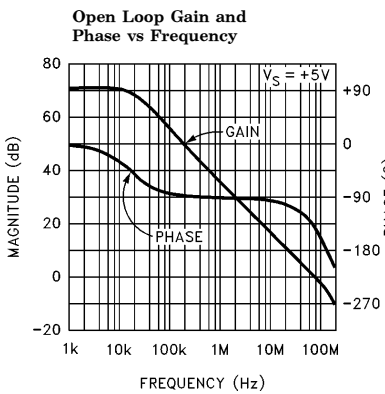
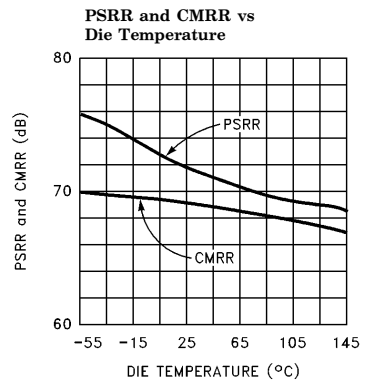
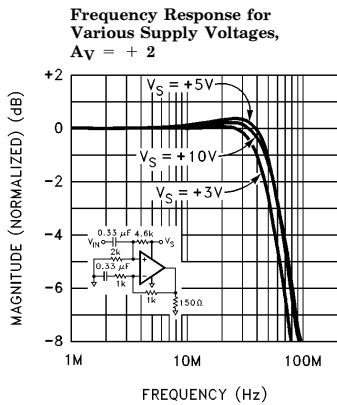
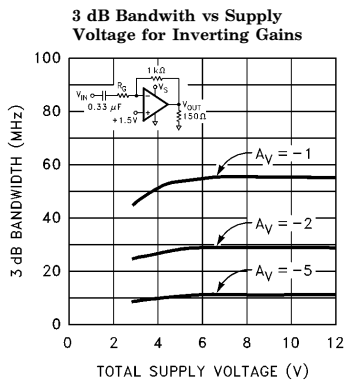
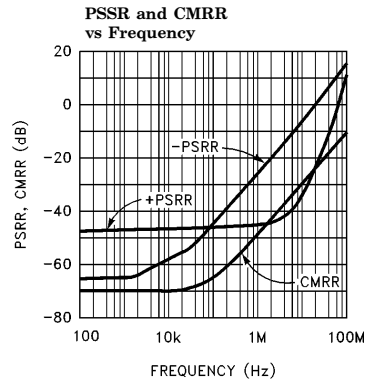
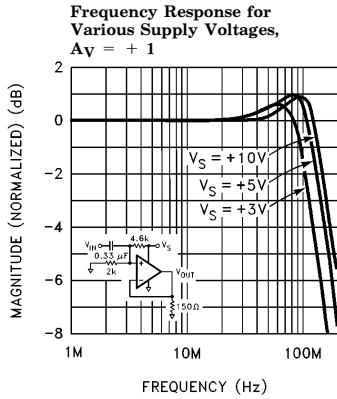
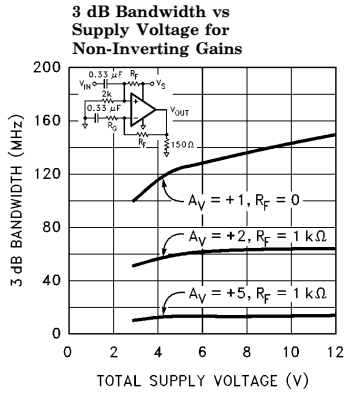

2150-75

EL2150C/EL2157C

125 MHz Single Supply, Clamping Op Amps

Typical Performance Curves — Contd.

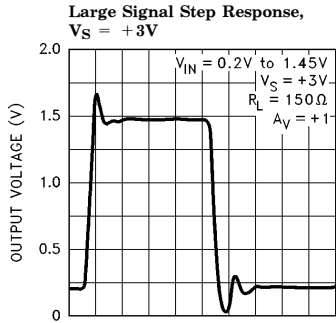

TIME 20 ns/div

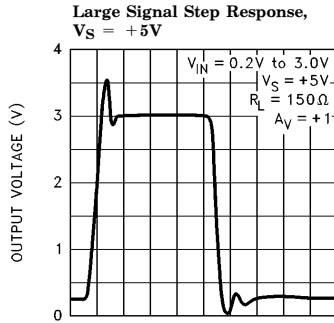

TIME 20 ns/div

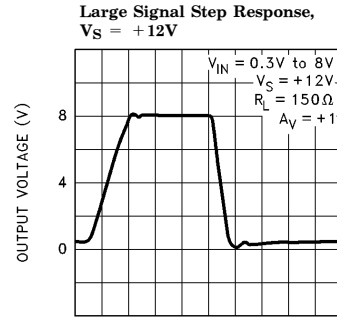

TIME 20 ns/div

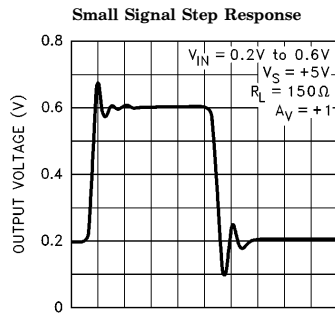

TIME 20 ns/div

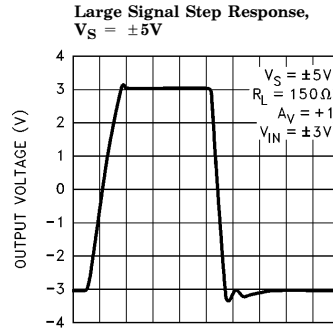

TIME 20 ns/div

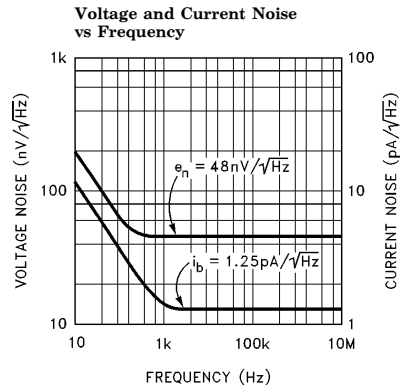
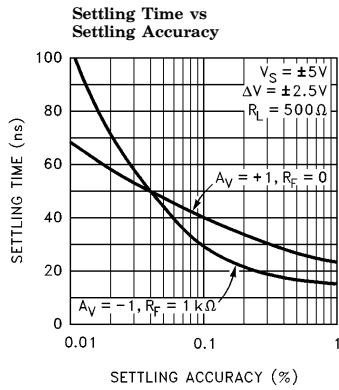
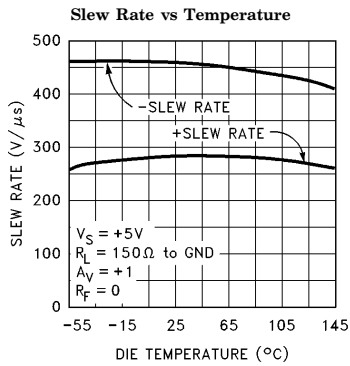

2150-76

EL2150C/EL2157C

125 MHz Single Supply, Clamping Op Amps

Typical Performance Curves — Contd.

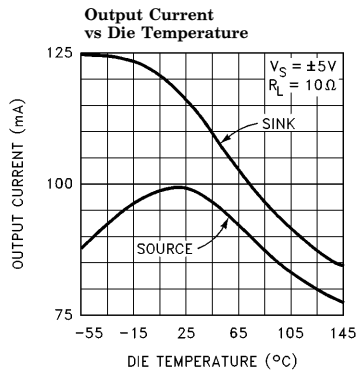
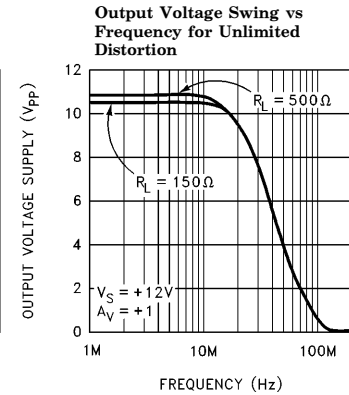
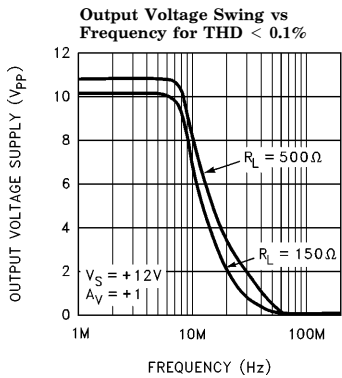
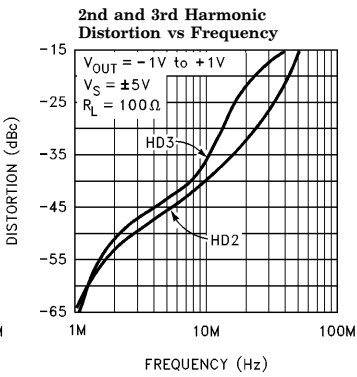
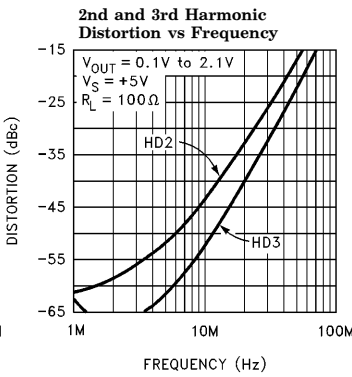
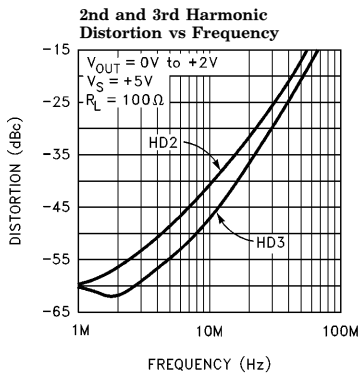
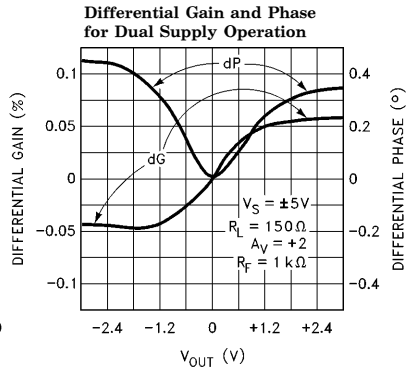
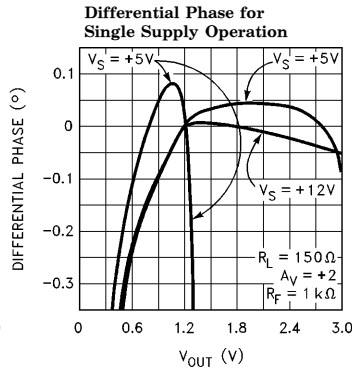
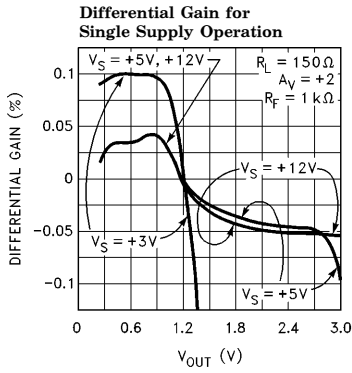

2150-77

EL2150C/EL2157C

125 MHz Single Supply, Clamping Op Amps

Typical Performance Curves — Contd.

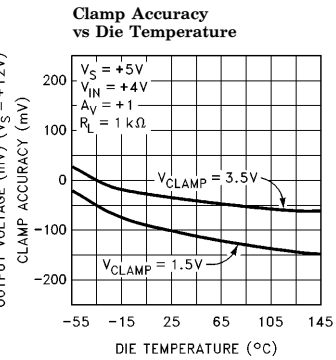
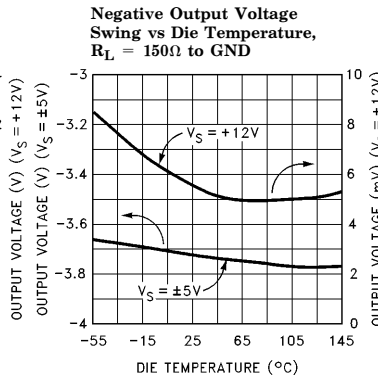
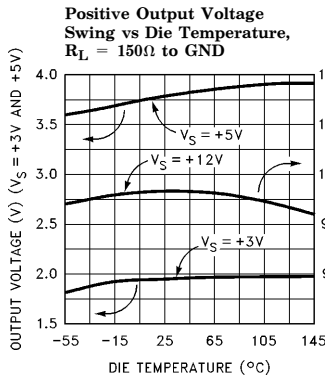
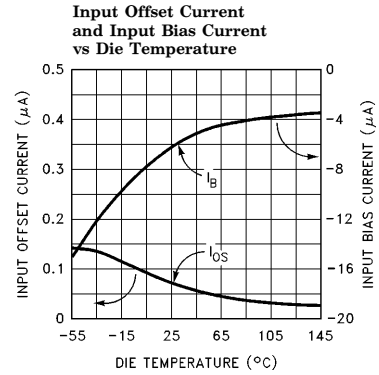
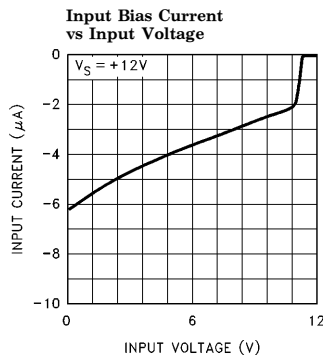
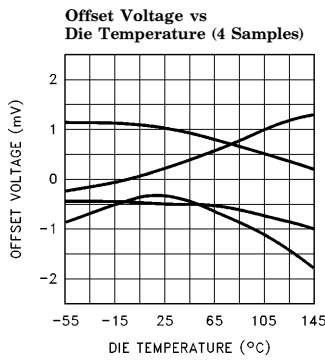
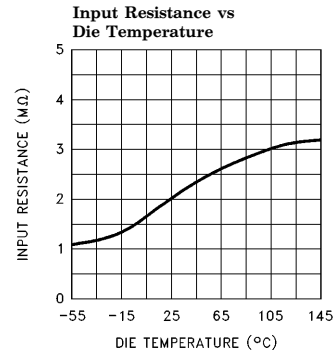
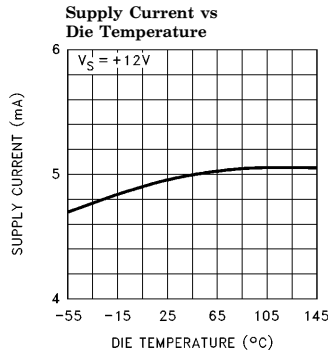
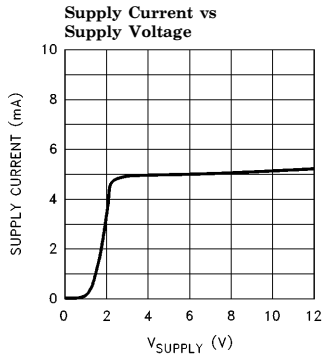

2150-78

EL2150C/EL2157C

125 MHz Single Supply, Clamping Op Amps

Typical Performance Curves — Contd.

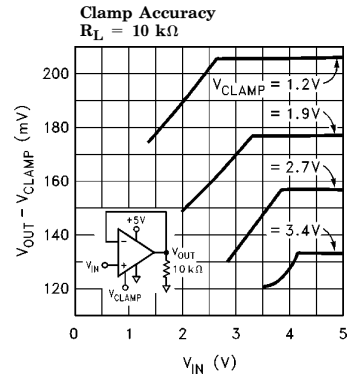
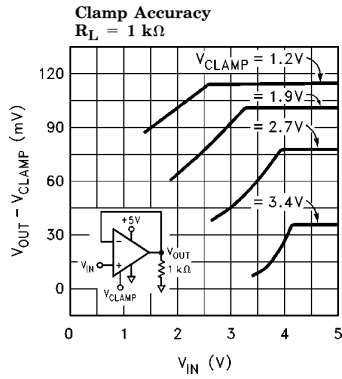
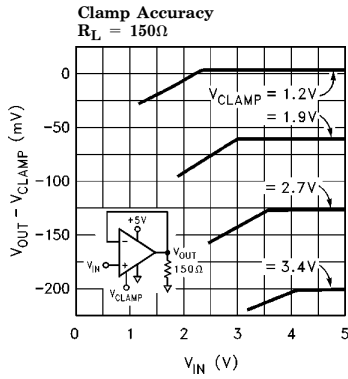

Enable Response for a Family of DC Inputs

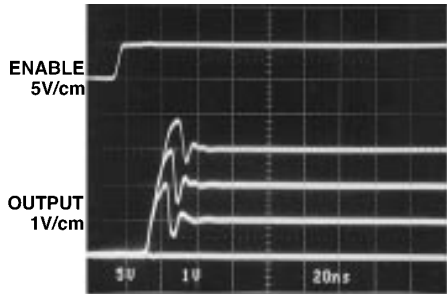

$A_V = +1$, $R_L = 150\Omega$, $V_S = +5V$

2150-51

Disable Response for a Family of DC Inputs

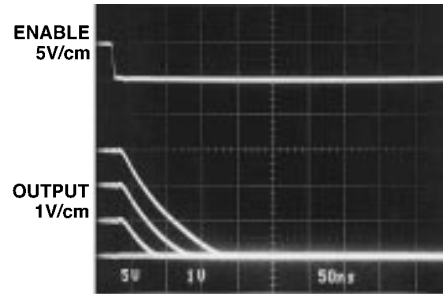

$A_V = +1$, $R_L = 150\Omega$, $V_S = +5V$

2150-52

Disable/Enable Response for a Family of Sine Waves

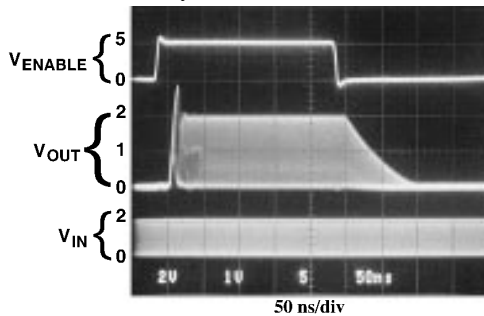

2150-53

OFF Isolation

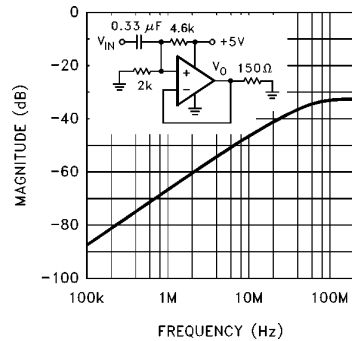

2150-72

EL2150C/EL2157C

125 MHz Single Supply, Clamping Op Amps

Typical Performance Curves — Contd.

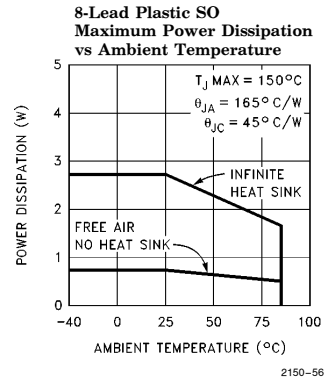
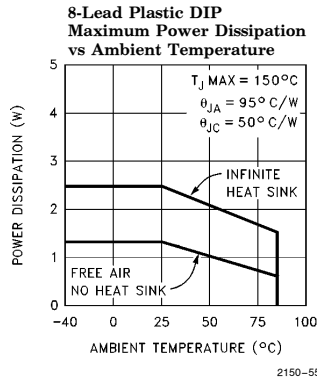
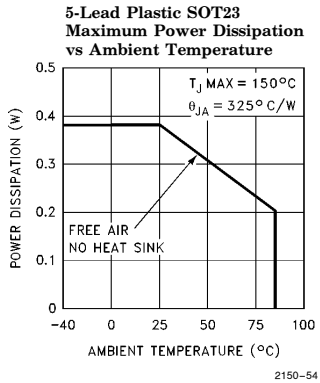

Burn-In Circuit

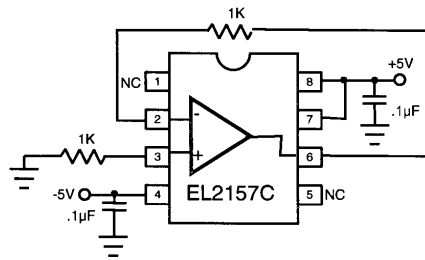

Simplified Schematic

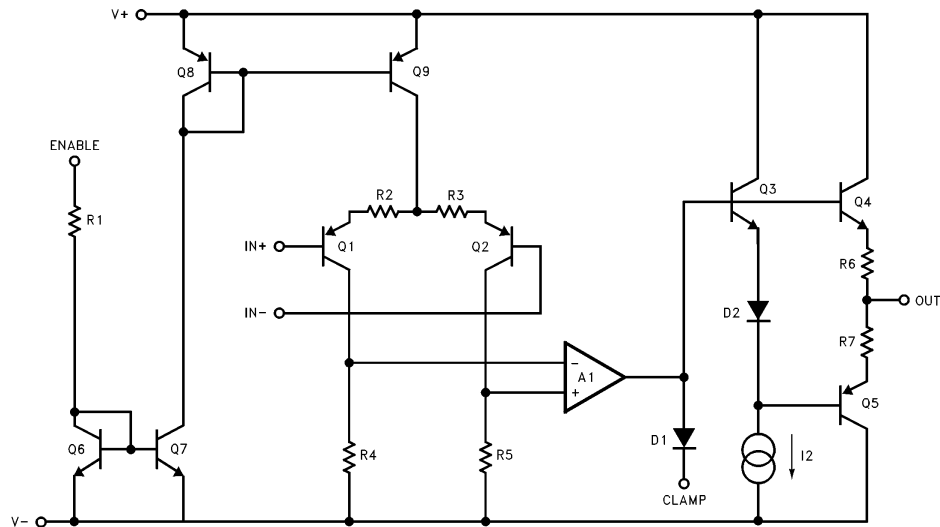

EL2150C/EL2157C

125 MHz Single Supply, Clamping Op Amps

Applications Information

Product Description

The EL2150C/EL2157C are the industry's fastest single supply operational amplifiers. Connected in voltage follower mode, their -3dB bandwidth is 125 MHz while maintaining a $275\text{ V}/\mu\text{s}$ slew rate. With an input and output common mode range that includes ground, these amplifiers were optimized for single supply operation, but will also accept dual supplies. They operate on a total supply voltage range as low as $+2.7\text{V}$ or up to $+12\text{V}$. This makes them ideal for $+3\text{V}$ applications, especially portable computers.

While many amplifiers claim to operate on a single supply, and some can sense ground at their inputs, most fail to truly drive their outputs to ground. If they do succeed in driving to ground, the amplifier often saturates, causing distortion and recovery delays. However, special circuitry built into the EL2150C/EL2157C allows the output to follow the input signal to ground without recovery delays.

Power Supply Bypassing And Printed Circuit Board Layout

As with any high-frequency device, good printed circuit board layout is necessary for optimum performance. Ground plane construction is highly recommended. Lead lengths should be as short as possible. The power supply pins must be well bypassed to reduce the risk of oscillation. The combination of a $4.7\ \mu\text{F}$ tantalum capacitor in parallel with a $0.1\ \mu\text{F}$ ceramic capacitor has been shown to work well when placed at each supply pin. For single supply operation, where pin 4 (V_{S-}) is connected to the ground plane, a single $4.7\ \mu\text{F}$ tantalum capacitor in parallel with a $0.1\ \mu\text{F}$ ceramic capacitor across pins 7 and 4 will suffice.

For good AC performance, parasitic capacitance should be kept to a minimum. Ground plane construction should be used. Carbon or Metal-Film resistors are acceptable with the Metal-Film resistors giving slightly less peaking and bandwidth because of their additional series inductance. Use of sockets, particularly for the SO package should be avoided if possible. Sockets add parasitic inductance and capacitance which will result in some additional peaking and overshoot.

Supply Voltage Range and Single-Supply Operation

The EL2150C/EL2157C have been designed to operate with supply voltages having a span of greater than 2.7V , and less than 12V . In practical terms, this means that the EL2150C/EL2157C will operate on dual supplies ranging from $\pm 1.35\text{V}$ to $\pm 6\text{V}$. With a single-supply, the EL2150C/EL2157C will operate from $+2.7\text{V}$ to $+12\text{V}$. Performance has been optimized for a single $+5\text{V}$ supply.

Pins 7 and 4 are the power supply pins. The positive power supply is connected to pin 7. When used in single supply mode, pin 4 is connected to ground. When used in dual supply mode, the negative power supply is connected to pin 4.

As supply voltages continue to decrease, it becomes necessary to provide input and output voltage ranges that can get as close as possible to the supply voltages. The EL2150C/EL2157C have an input voltage range that includes the negative supply and extends to within 1.2V of the positive supply. So, for example, on a single $+5\text{V}$ supply, the EL2150C/EL2157C have an input range which spans from 0V to 3.8V .

The output range of the EL2150C/EL2157C is also quite large. It includes the negative rail, and extends to within 1V of the top supply rail. On a $+5\text{V}$ supply, the output is therefore capable of swinging from 0V to $+4\text{V}$. On split supplies, the output will swing $\pm 4\text{V}$. If the load resistor is tied to the negative rail and split supplies are used, the output range is extended to the negative rail.

Choice Of Feedback Resistor, R_F

The feedback resistor forms a pole with the input capacitance. As this pole becomes larger, phase margin is reduced. This increases ringing in the time domain and peaking in the frequency domain. Therefore, R_F has some maximum value which should not be exceeded for optimum performance. If a large value of R_F must be used, a small capacitor in the few picofarad range in parallel with R_F can help to reduce this ringing and peaking at the expense of reducing the bandwidth.

EL2150C/EL2157C

125 MHz Single Supply, Clamping Op Amps

Applications Information — Contd.

As far as the output stage of the amplifier is concerned, $R_F + R_G$ appear in parallel with R_L for gains other than +1. As this combination gets smaller, the bandwidth falls off. Consequently, R_F has a minimum value that should not be exceeded for optimum performance.

For $A_V = +1$, $R_F = 0\Omega$ is optimum. For $A_V = -1$ or $+2$ (noise gain of 2), optimum response is obtained with R_F between 500Ω and $1\text{ k}\Omega$. For $A_V = -4$ or $+5$ (noise gain of 5), keep R_F between $2\text{ k}\Omega$ and $10\text{ k}\Omega$.

Video Performance

For good video performance, an amplifier is required to maintain the same output impedance and the same frequency response as DC levels are changed at the output. This can be difficult when driving a standard video load of 150Ω , because of the change in output current with DC level. Differential Gain and Differential Phase for the EL2150C/EL2157C are specified with the black level of the output video signal set to $+1.2\text{V}$. This allows ample room for the sync pulse even in a gain of $+2$ configuration. This results in dG and dP specifications of 0.05% and 0.05° while driving 150Ω at a gain of $+2$. Setting the black level to other values, although acceptable, will compromise peak performance. For example, looking at the single supply dG and dP curves for $R_L = 150\Omega$, if the output black level clamp is reduced from 1.2V to 0.6V dG/dP will increase from $0.05\%/0.05^\circ$ to $0.08\%/0.25^\circ$. Note that in a gain of $+2$ configuration, this is the lowest black level allowed such that the sync tip doesn't go below 0V .

If your application requires that the output goes to ground, then the output stage of the EL2150C/EL2157C, like all other single supply op amps, requires an external pull down resistor tied to ground. As mentioned above, the current flowing through this resistor becomes the DC bias current for the output stage NPN transistor. As this current approaches zero, the NPN turns off, and dG and dP will increase. This becomes more critical as the load resistor is increased in value. While driving a light load, such as $1\text{ k}\Omega$, if the input black level is kept above 1.25V , dG and dP are a respectable 0.03% and 0.03° .

For other biasing conditions see the Differential Gain and Differential Phase vs. Input Voltage curves.

Output Drive Capability

In spite of their moderately low 5 mA of supply current, the EL2150C/EL2157C are capable of providing $\pm 100\text{ mA}$ of output current into a 10Ω load, or $\pm 60\text{ mA}$ into 50Ω . With this large output current capability, a 50Ω load can be driven to $\pm 3\text{V}$ with $V_S = \pm 5\text{V}$, making it an excellent choice for driving isolation transformers in telecommunications applications.

Driving Cables and Capacitive Loads

When used as a cable driver, double termination is always recommended for reflection-free performance. For those applications, the back-termination series resistor will de-couple the EL2150C/EL2157C from the cable and allow extensive capacitive drive. However, other applications may have high capacitive loads without a back-termination resistor. In these applications, a small series resistor (usually between 5Ω and 50Ω) can be placed in series with the output to eliminate most peaking. The gain resistor (R_G) can then be chosen to make up for any gain loss which may be created by this additional resistor at the output.

Disable/Power-Down

The EL2157C amplifier can be disabled, placing its output in a high-impedance state. The disable or enable action takes only about 40 nsec . When disabled, the amplifier's supply current is reduced to 0 mA , thereby eliminating all power consumption by the EL2157C. The EL2157C amplifier's power down can be controlled by standard CMOS signal levels at the ENABLE pin. The applied CMOS signal is relative to the GND pin. For example, if a single $+5\text{V}$ supply is used, the logic voltage levels will be $+0.5\text{V}$ and $+2.0\text{V}$. If using dual $\pm 5\text{V}$ supplies, the logic levels will be -4.5V and -3.0V . Letting the ENABLE pin float will disable the EL2157C. If the power-down feature is not desired, connect the ENABLE pin to the V_{S+} pin. The guaranteed logic levels of $+0.5\text{V}$ and $+2.0\text{V}$ are not standard TTL levels of $+0.8\text{V}$ and $+2.0\text{V}$, so care must be taken if standard TTL will be used to drive the ENABLE pin.

EL2150C/EL2157C

125 MHz Single Supply, Clamping Op Amps

Applications Information — Contd.

Output Voltage Clamp

The EL2157C amplifier has an output voltage clamp. This clamping action is fast, being activated almost instantaneously, and being deactivated in < 7 ns, and prevents the output voltage from going above the preset clamp voltage. This can be very helpful when the EL2157C is used to drive an A/D converter, as some converters can require long times to recover if overdriven. The output voltage remains at the clamp voltage level as long as the product of the input voltage and the gain setting exceeds the clamp voltage. If the EL2157C is connected in a gain of 2, for example, and +3V DC is applied to the CLAMP pin, any voltage higher than +1.5V at the inputs will be clamped and +3V will be seen at the output.

Figure 1 below is a unity gain connected EL2157C being driven by a 3Vp-p sinewave, with 2.25V applied to the CLAMP pin. The resulting output waveform, with its output being clamped to 2.25V, is shown in Figure 2.

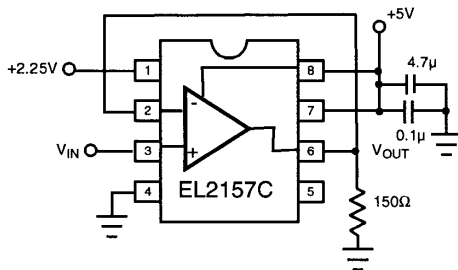

Figure 1

2150-59

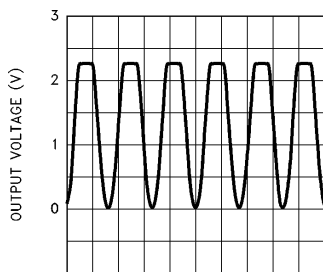

Figure 2

2150-60

Figure 3 shows the output of the same circuit being driven by a 0.5V to 2.75V square wave, as the clamp voltage is varied from 1.0V to 2.5V, as well as the unclamped output signal. The rising edge of the signal is clamped to the voltage applied to the CLAMP pin almost instantaneously. The output recovers from the clamped mode within 5 - 7 ns, depending on the clamp voltage. Even when the CLAMP pin is taken 0.2V below the minimum 1.2V specified, the output is still clamped and recovers in about 11 ns.

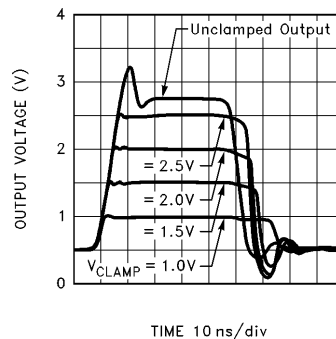

Figure 3

2150-61

The clamp accuracy is affected by 1) the CLAMP pin voltage, 2) the input voltage, and 3) the load resistor. Depending upon the application, the accuracy may be as little as a few tens of millivolts to a few hundred millivolts. Be sure to allow for these inaccuracies when choosing the clamp voltage. Curves of Clamp Accuracy vs. V_{CLAMP} , and V_{IN} for 3 values of R_L are included in the Typical Performance Curves Section

Unlike amplifiers that clamp at the input and are therefore limited to non-inverting applications only, the EL2157C output clamp architecture works for both inverting and non-inverting gain applications. There is also no maximum voltage difference limitation between V_{IN} and V_{CLAMP} which is common on input clamped architectures.

The voltage clamp operates for any voltage between +1.2V above the GND pin, and the minimum output voltage swing, V_{OP} . Forcing the CLAMP pin much below +1.2V can saturate transistors and should therefore be avoided.

EL2150C/EL2157C

125 MHz Single Supply, Clamping Op Amps

Applications Information — Contd.

Forcing the CLAMP pin above V_{OP} simply deactivates the CLAMP feature. In other words, one cannot expect to clamp any voltage higher than what the EL2157C can drive to in the first place. If the clamp feature is not desired, either let the CLAMP pin float or connect it to the V_{S+} pin.

EL2157C Comparator Application

The EL2157C can be used as a very fast, single supply comparator by utilizing the clamp feature. Most op amps used as comparators allow only slow speed operation because of output saturation issues. However, by applying a DC voltage to the CLAMP pin of the EL2157C, the maximum output voltage can be clamped, thus preventing saturation. Figure 4 below is the EL2157C implemented as a comparator. 2.5V DC is applied to the CLAMP pin, as well as the $IN-$ pin. A differential signal is then applied between the inputs. Figure 5 shows the output square wave that results when a $\pm 1V$, 10 MHz triangular wave is applied, while Figure 6 is a graph of propagation delay vs. overdrive as a square wave is presented at the input.

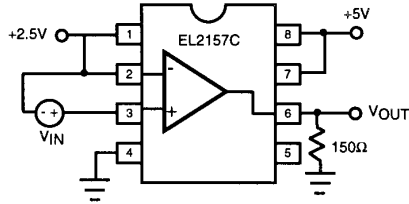

Figure 4

2150-62

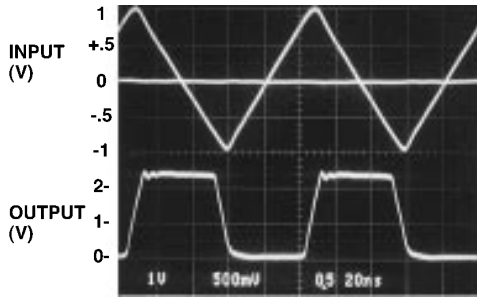

Figure 5

2150-63

Propagation Delay vs Overdrive
EL2157 as a Comparator

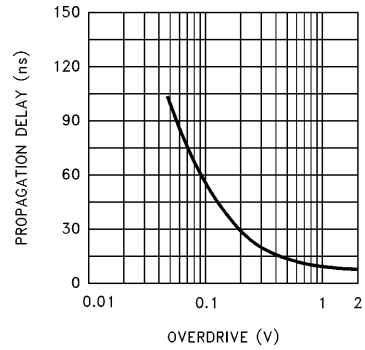

Figure 6

2150-64

Video Sync Pulse Remover Application

All CMOS Analog to Digital Converters (A/Ds) have a parasitic latch-up problem when subjected to negative input voltage levels. Since the sync tip contains no useful video information and it is a negative going pulse, we can chop it off. Figure 7 shows a unity gain connected EL2150C/EL2157C. Figure 8 shows the complete input video signal applied at the input, as well as the output signal with the negative going sync pulse removed.

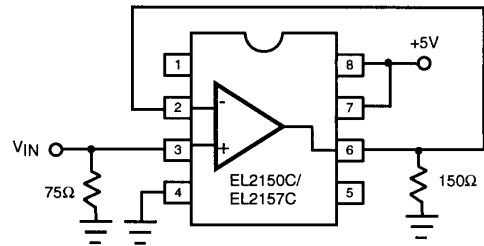

Figure 7

2150-65

EL2150C/EL2157C

125 MHz Single Supply, Clamping Op Amps

Applications Information — Contd.

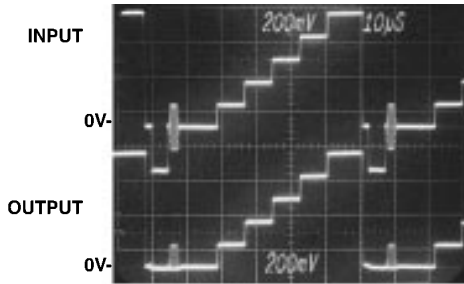

Figure 8

2150-66

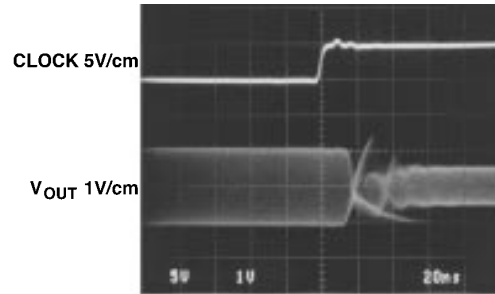

Figure 10

2150-68

Multiplexing with the EL2157C

The ENABLE pin on the EL2157C allows for multiplexing applications. Figure 9 shows two EL2157Cs with their outputs tied together, driving a back terminated 75Ω video load. A 2 V_{p-p} 10 MHz sinewave is applied at one input, and a 1 V_{p-p} 5 MHz sinewave to the other. Figure 10 shows the CLOCK signal which is applied, and the resulting output waveform at V_{OUT}. Switching is complete in about 50 ns. Notice the outputs are tied directly together. Decoupling resistors at each output are not necessary. In fact, adding them approximately doubles the switching time to 100 nsec.

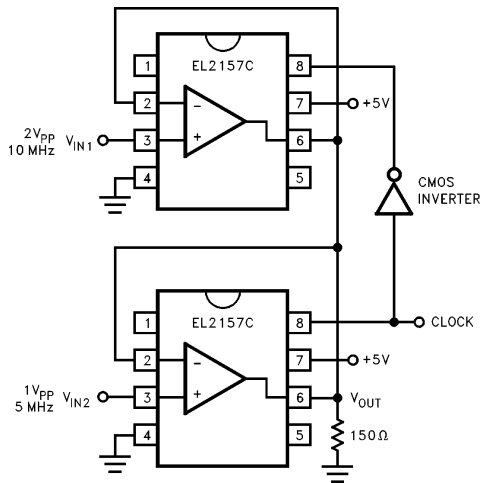

Figure 9

2150-67

Short Circuit Current Limit

The EL2150C/EL2157C have internal short circuit protection circuitry that protect it in the event of its output being shorted to either supply rail. This limit is set to around 100 mA nominally and reduces with increasing junction temperature. It is intended to handle temporary shorts. If an output is shorted indefinitely, the power dissipation could easily increase such that the part will be destroyed. Maximum reliability is maintained if the output current never exceeds ± 90 mA. A heat sink may be required to keep the junction temperature below absolute maximum when an output is shorted indefinitely.

Power Dissipation

With the high output drive capability of the EL2150C/EL2157C, it is possible to exceed the 150°C Absolute Maximum junction temperature under certain load current conditions. Therefore, it is important to calculate the maximum junction temperature for the application to determine if power-supply voltages, load conditions, or package type need to be modified for the EL2150C/EL2157C to remain in the safe operating area.

EL2150C/EL2157C

125 MHz Single Supply, Clamping Op Amps

Applications Information — Contd.

The maximum power dissipation allowed in a package is determined according to [1]:

$$PD_{MAX} = \frac{T_{JMAX} - T_{AMAX}}{\theta_{JA}} \quad [1]$$

where:

T_{JMAX} = Maximum Junction Temperature
 T_{AMAX} = Maximum Ambient Temperature
 θ_{JA} = Thermal Resistance of the Package
 PD_{MAX} = Maximum Power Dissipation in the Package.

The maximum power dissipation actually produced by an IC is the total quiescent supply current times the total power supply voltage, plus the power in the IC due to the load, or [2]

$$PD_{MAX} = V_S * I_{SMAX} + (V_S - V_{OUT}) * \frac{V_{OUT}}{R_L} \quad [2]$$

where:

V_S = Total Supply Voltage
 I_{SMAX} = Maximum Supply Current
 V_{OUT} = Maximum Output Voltage of the Application
 R_L = Load Resistance tied to Ground

If we set the two PD_{MAX} equations, [1] & [2], equal to each other, and solve for V_S , we can get a family of curves for various loads and output voltages according to [3]:

$$V_S = \frac{R_L * (T_{JMAX} - T_{AMAX})}{\theta_{JA} * (I_S * R_L) + V_{OUT}} + (V_{OUT})^2 \quad [3]$$

Figures 11 through 13 show total single supply voltage V_S vs. R_L for various output voltage swings for the PDIP and SOIC packages. The curves assume WORST CASE conditions of $T_A = +85^\circ\text{C}$ and $I_S = 6.5 \text{ mA}$.

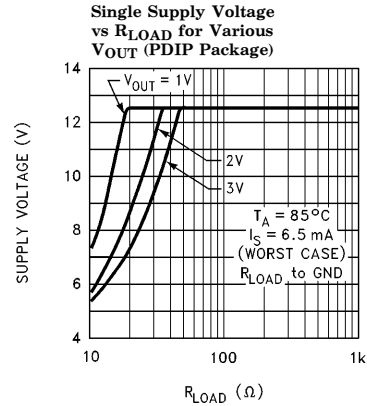

Figure 11

2150-69

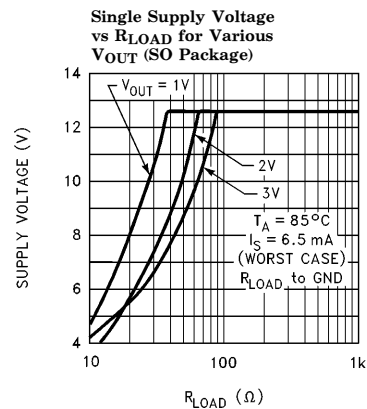

Figure 12

2150-70

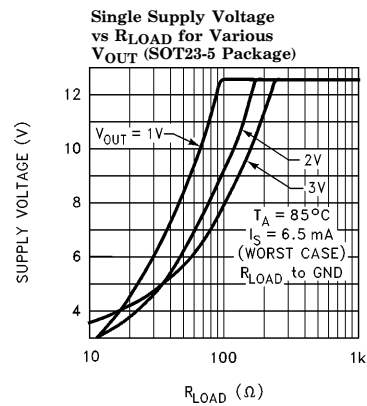

Figure 13

2150-73

EL2150C/EL2157C

125 MHz Single Supply, Clamping Op Amps

Applications Information — Contd.

EL2157C Macromodel

* Revision A, July 1995

* When not being used, the clamp pin, pin 1,
* should be connected to +Vsupply, pin 7

* Connections:

	+ input		- input		+ Vsupply		- Vsupply		output		clamp
*											
*											
*											
*											
*											
*											
.	subckt EL2157/el	3	2	7	4	6	1				

* Input Stage

*
i1 7 10 250uA
i2 7 11 250uA
r1 10 11 4k
q1 12 2 10 qp
q2 13 3 11 qpa
r2 12 4 100
r3 13 4 100

* Second Stage & Compensation

*
gm 15 4 13 12 4.6m
r4 15 4 15Meg
c1 15 4 0.36pF

* Poles

*
e1 17 4 15 4 1.0
r6 17 25 400
c3 25 4 1pF
r7 25 18 500
c4 18 4 1pF

* Output Stage & Clamp

*
i3 20 4 1.0mA
q3 7 23 20 qn
q4 7 18 19 qn
q5 7 18 21 qn
q6 4 20 22 qp
q7 7 23 18 qn
d1 19 20 da
d2 18 1 da
r8 21 6 2
r9 22 6 2
r10 18 21 10k
r11 7 23 100k
d3 23 24 da
d4 24 4 da
d5 23 18 da

* Power Supply Current

*
ips 7 4 3.2mA

* Models

*
.model qn npn(is = 800e-18 bf = 150 tf = 0.02nS)
.model qpa pnp(is = 810e-18 bf = 50 tf = 0.02nS)
.model qp pnp(is = 800e-18 bf = 54 tf = 0.02nS)
.model da d(tt = 0nS)
.ends

EL2150C/EL2157C

125 MHz Single Supply, Clamping Op Amps

EL2157C Macromodel — Contd.

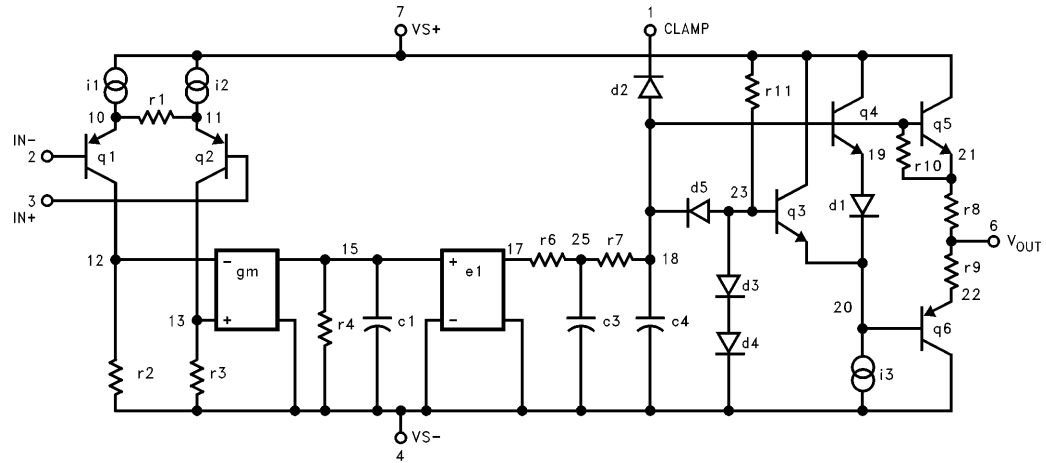

2150-71

EL2150C/EL2157C

125 MHz Single Supply, Clamping Op Amps

General Disclaimer

Specifications contained in this data sheet are in effect as of the publication date shown. Elantec, Inc. reserves the right to make changes in the circuitry or specifications contained herein at any time without notice. Elantec, Inc. assumes no responsibility for the use of any circuits described herein and makes no representations that they are free from patent infringement.



Elantec, Inc.

1996 Tarob Court

Milpitas, CA 95035

Telephone: (408) 945-1323

(800) 333-6314

Fax: (408) 945-9305

European Office: 44-71-482-4596

WARNING — Life Support Policy

Elantec, Inc. products are not authorized for and should not be used within Life Support Systems without the specific written consent of Elantec, Inc. Life Support systems are equipment intended to support or sustain life and whose failure to perform when properly used in accordance with instructions provided can be reasonably expected to result in significant personal injury or death. Users contemplating application of Elantec, Inc. products in Life Support Systems are requested to contact Elantec, Inc. factory headquarters to establish suitable terms & conditions for these applications. Elantec, Inc.'s warranty is limited to replacement of defective components and does not cover injury to persons or property or other consequential damages.