

**FEATURES**

- -55°C to +125°C operation
- 16 to 40 VDC input
- Fully isolated
- Magnetic feedback
- Fixed frequency 550 kHz typ.
- Topology – Single Ended Forward
- Will withstand transients of up to 50 V for up to 120 msec.
- Output trim 60% to 110%
- Input and output side inhibit
- Remote sense
- Synchronization
- Parallel up to 5 units
- Output short circuit protection
- Up to 80 W/in<sup>3</sup>, 87% efficiency

# DC/DC CONVERTERS 28 VOLT INPUT

## MOR SERIES 120 WATT



MODELS	
VDC OUTPUT	
SINGLES	DUALS
3.3	±3.3
5	±5
6.3	±6.3
9.5	±9.5
12	±12
15	±15

Size (max): 3.005 x 1.505 x 0.400 inches (76.33 x 38.23 x 10.16 mm) case U2  
 Case U2 (flanged, short leads) and case Z (tabbed, leads bent down) are shown in the picture. Also available: flanged – leads bent down (case V); tabbed – short leads (case Y) and leads bent up (case W). See Section B8, cases U2, V, W, Y, and Z for dimensions and options.  
 Weight: 110 grams typical  
 Screening: Standard, ES, or 883 (Class H). See Section C2 for screening options, see Section A5 for ordering information.

**DESCRIPTION**

With up to 120 watts of output power, the MOR Series™ of DC/DC converters operates from a standard 28 volt bus and offers a wide input range of 16 to 40 VDC. Full operation over the military temperature range, -55°C to +125°C, makes the MOR Series an ideal choice for military, aerospace, space, and other high reliability applications. In compliance with MIL-STD-704D, the converters will withstand transients of up to 50 volts for up to 120 milliseconds. Use Interpoint's FME28-461 EMI filter to pass MIL-STD-461C, CE03 requirements.

(PWM) current mode control design and switches at 550 kHz, nominal. The converters also provide short circuit protection by restricting the current to 125% of the full load output current. All models offer two inhibits, one referenced to input common and one referenced to output common. A remote sense function is available on single output models.

Using the trim function, the MOR Series can provide any output from 2 to 33 VDC. For example, trimming the two 15 volt outputs of the 15 dual (MOR2815D) to 14 volts, and then stacking the outputs will provide a 28 volt output. See Figure 11.

The MOR Series converters incorporate a single-ended forward topology which uses a constant frequency Pulse Width Modulator

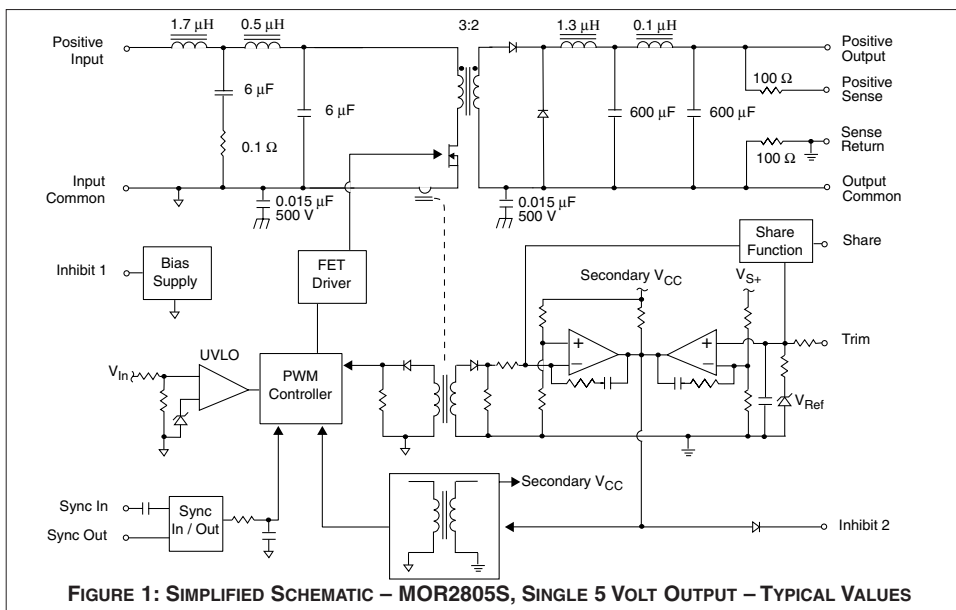

FIGURE 1: SIMPLIFIED SCHEMATIC – MOR2805S, SINGLE 5 VOLT OUTPUT – TYPICAL VALUES

# MOR SERIES 120 WATT

# DC/DC CONVERTERS

ABSOLUTE MAXIMUM RATINGS	
<b>Input Voltage</b>	• 16 to 40 VDC
<b>Power Dissipation (Pd)</b>	• 30 W
<b>Output Power</b>	• 66 to 120 watts depending on model
<b>Lead Soldering Temperature (10 sec per lead)</b>	• 300°C
<b>Storage Temperature Range (Case)</b>	• -65°C to +150°C

SYNC AND INHIBIT (INH1, INH2)	
<b>Sync In (525 to 625 kHz)</b>	<ul style="list-style-type: none"> <li>Logic low 0.8 V max, duty cycle 15% to 50%</li> <li>Logic high 4.5 V min, 9 V max</li> <li>Referenced to input common</li> </ul>
<b>Sync Out - Referenced to input common</b>	
<b>Inhibit (INH1, INH2) : TTL Open Collector</b>	<ul style="list-style-type: none"> <li>Logic low (output disabled), V = 0.2 V max.</li> <li>INH1 referenced to input common</li> <li>INH2 referenced to output common</li> <li>Logic high (output enabled) open collector</li> </ul>

TYPICAL CHARACTERISTICS	
<b>Output Voltage Temperature Coefficient</b>	• 100 ppm/°C typical
<b>Input to Output Capacitance</b>	• 150 pF typical
<b>Undervoltage Lockout</b>	• 15.5 V input typical
<b>Current Limit</b>	• 125% of full load typical
<b>Isolation</b>	• 100 megohm minimum at 500 V
<b>Audio Rejection</b>	• 40 dB typical
<b>Conversion Frequency</b>	<ul style="list-style-type: none"> <li>Free run mode 550 kHz typical</li> <li>460 kHz. min, 570 kHz max</li> <li>External sync range 525 to 625 kHz</li> </ul>
<b>Inhibit Pin Voltage (unit enabled)</b>	• INH1 = 13 V typ, INH2 = 8 V typ

RECOMMENDED OPERATING CONDITIONS	
<b>Input Voltage Range</b>	<ul style="list-style-type: none"> <li>16 to 40 VDC continuous</li> <li>50 V for 120 msec transient</li> </ul>
<b>Case Operating Temperature (Tc)</b>	<ul style="list-style-type: none"> <li>-55°C to +125°C full power</li> <li>-55°C to +135°C absolute</li> </ul>
<b>Derating Output Power/Current</b>	• Linearly from 100% at 125°C to 0% at 135° C

PINS NOT IN USE	
<b>Trim</b>	No connection
<b>Case</b>	Users discrimination
<b>Inhibit (INH1, INH2)</b>	No connection
<b>Sync Out</b>	No connection
<b>Sync In</b>	Connect to input common
<b>Share</b>	No connection
<b>Sense Lines</b>	Must be connected to appropriate outputs

Electrical Characteristics: 25°C Tc, 28 VDC Vin, 100% load, free run, unless otherwise specified.

SINGLE OUTPUT MODELS		MOR283R3S			MOR2805S			MOR286R3S			MOR289R5S			UNITS
PARAMETER	CONDITION	MIN	TYP	MAX	MIN	TYP	MAX	MIN	TYP	MAX	MIN	TYP	MAX	
OUTPUT VOLTAGE		3.25	3.30	3.35	4.95	5.00	5.05	6.24	6.30	6.36	9.40	9.50	9.60	VDC
OUTPUT CURRENT	V <sub>IN</sub> = 16 to 40 VDC	0	—	20	0	—	20	0	—	16	0	—	11	A
OUTPUT POWER	V <sub>IN</sub> = 16 to 40 VDC	0	—	66	0	—	100	0	—	100	0	—	105	W
OUTPUT RIPPLE VOLTAGE	10 kHz - 20 MHz Tc = -55°C to +125°C	—	30	80	—	30	80	—	75	100	—	75	120	mV p-p
	10 kHz - 2 MHz Tc = -55°C to +125°C	—	20	50	—	20	50	—	50	60	—	50	80	
LINE REGULATION	V <sub>IN</sub> = 16 to 40 VDC	—	0	20	—	0	20	—	0	20	—	0	20	mV
LOAD REGULATION	NO LOAD TO FULL	—	0	20	—	0	20	—	0	20	—	0	20	mV
INPUT VOLTAGE	CONTINUOUS	16	28	40	16	28	40	16	28	40	16	28	40	VDC
	TRANSIENT 120 ms	—	—	50	—	—	50	—	—	50	—	—	50	V
INPUT CURRENT	NO LOAD	—	70	130	—	70	130	—	70	130	—	70	130	mA
	FULL LOAD	—	—	3.2	—	—	4.67	—	—	4.45	—	—	4.63	A
	INHIBITED - INH1	—	—	10	—	—	10	—	—	10	—	—	10	mA
	INHIBITED - INH2	—	—	70	—	—	70	—	—	70	—	—	70	
INPUT RIPPLE CURRENT	10 kHz - 20 MHz Tc = -55°C to +125°C	—	40	90	—	50	130	—	50	100	—	50	130	mA pp
EFFICIENCY		74	78	—	78	81	—	81	83	—	81	84	—	%
LOAD FAULT <sup>1</sup>	POWER DISSIPATION OVERLOAD	—	—	27	—	—	30	—	—	30	—	—	30	W
	SHORT CIRCUIT <sup>2</sup>	—	—	22	—	—	27	—	—	24	—	—	24	
	RECOVERY	—	—	10	—	—	10	—	—	10	—	—	10	ms
	OUTPUT CURRENT TRIP POINT	—	—	25	—	—	25	—	—	20	—	—	14	A
	SHORT CIRCUIT <sup>2</sup>	—	—	24	—	—	24	—	—	19	—	—	13	
STEP LOAD RESP.	50% - 100% - 50%													
	TRANSIENT	—	—	250	—	—	250	—	—	500	—	—	500	mV pk
	RECOVERY <sup>3</sup>	—	—	200	—	—	200	—	—	300	—	—	300	µs
STEP LINE RESP.	16 - 40 - 16 VDC													
	TRANSIENT <sup>4</sup>	—	—	400	—	—	400	—	—	500	—	—	500	mV pk
	RECOVERY <sup>3</sup>	—	—	300	—	—	300	—	—	300	—	—	300	µs
START-UP	DELAY	—	—	10	—	—	10	—	—	10	—	—	10	ms
	OVERSHOOT	—	0	25	—	0	50	—	0	50	—	0	50	mV pk
INHIBIT PIN CURRENT	UNIT INHIBITED	—	0.1	1.0	—	0.1	1.0	—	0.1	1.0	—	0.1	1.0	mA

Notes: See notes 1, 2, 3, and 4 on the following page.

# DC/DC CONVERTERS

# MOR SERIES 120 WATT

Electrical Characteristics: 25°C Tc, 28 VDC Vin, 100% load, free run, unless otherwise specified.

SINGLE AND DUAL OUTPUT MODELS		MOR2812S			MOR2815S			MOR283R3D			MOR2805D			UNITS	
PARAMETER	CONDITIONS	MIN	TYP	MAX	MIN	TYP	MAX	MIN	TYP	MAX	MIN	TYP	MAX		
OUTPUT VOLTAGE <sup>5</sup>	+V <sub>OUT</sub>	11.88	12.00	12.12	14.85	15.00	15.15	3.25	3.30	3.35	4.95	5.00	5.05	VDC	
	-V <sub>OUT</sub>	—	—	—	—	—	—	3.22	3.30	3.38	4.92	5.00	5.08		
OUTPUT CURRENT	V <sub>IN</sub> = 16 to 40 VDC	0	—	9.2	0	—	8	—	±10	20 <sup>6</sup>	—	±10	20 <sup>6</sup>	A	
OUTPUT POWER	V <sub>IN</sub> = 16 to 40 VDC	—	—	110	—	—	120	—	—	66 <sup>6</sup>	—	—	100 <sup>6</sup>	W	
OUTPUT RIPPLE VOLTAGE +V <sub>OUT</sub> , ±V <sub>OUT</sub>	10 kHz - 20 MHz Tc = -55°C to +125°C	—	75	120	—	75	150	—	50	80	—	50	80	mV p-p	
	10 kHz - 2 MHz Tc = -55°C to +125°C	—	50	100	—	50	120	—	35	50	—	35	50		
LINE REGULATION V <sub>IN</sub> = 16 to 40 VDC	+V <sub>OUT</sub>	—	0	20	—	0	20	—	25	50	—	25	50	mV	
	-V <sub>OUT</sub>	—	—	—	—	—	—	—	50	100	—	50	100		
LOAD REGULATION	+V <sub>OUT</sub>	—	0	20	—	0	20	—	25	50	—	25	50	mV	
	-V <sub>OUT</sub>	—	—	—	—	—	—	—	50	150	—	50	150		
CROSS REGULATION <sup>7</sup>	NEGATIVE V <sub>OUT</sub>	—	—	—	—	—	—	—	6	10	—	5	8	%	
INPUT VOLTAGE	CONTINUOUS	16	28	40	16	28	40	16	28	40	16	28	40	VDC	
	TRANSIENT 120 msec	—	—	50	—	—	50	—	—	50	—	—	50	V	
INPUT CURRENT	NO LOAD	—	70	130	—	70	130	—	70	140	—	70	140	mA	
	FULL LOAD	—	—	4.72	—	—	5.10	—	—	3.2	—	—	4.67		A
	INHIBITED - INH1	—	—	10	—	—	10	—	—	10	—	—	10	mA	
	INHIBITED - INH2	—	—	70	—	—	70	—	—	70	—	—	70		
INPUT RIPPLE CURRENT	10 kHz - 20 MHz Tc = -55°C to +125°C	—	50	130	—	50	130	—	60	130	—	60	130	mA p-p	
EFFICIENCY		84	86	—	84	87	—	76	77	—	78	81	—	%	
LOAD FAULT <sup>1</sup>	POWER DISSIPATION	OVERLOAD	—	—	30	—	—	30	—	—	27	—	—	30	W
		SHORT CIRCUIT <sup>2</sup>	—	—	22	—	—	22	—	—	22	—	—	27	
		RECOVERY	—	—	10	—	—	10	—	—	10	—	—	10	
	OUTPUT CURRENT	TRIP POINT	—	—	12	—	—	10	—	—	25	—	—	25	A
SHORT CIRCUIT <sup>2</sup>		—	—	11	—	—	9	—	—	24	—	—	24		
STEP LOAD RESP. +V <sub>OUT</sub> , ±V <sub>OUT</sub>	50% - 100% - 50%	—	—	—	—	—	—	—	—	—	—	—	—	mV pk	
	TRANSIENT RECOVERY <sup>3</sup>	—	—	600	—	—	600	—	—	250	—	—	250		µs
STEP LINE RESP. +V <sub>OUT</sub> , ±V <sub>OUT</sub>	16 - 40 - 16 VDC	—	—	—	—	—	—	—	—	—	—	—	—	mV pk	
	TRANSIENT <sup>4</sup> RECOVERY <sup>3</sup>	—	—	600	—	—	600	—	—	400	—	—	400		µs
START-UP	DELAY	—	—	10	—	—	10	—	—	10	—	—	10	ms	
	OVERSHOOT	—	—	50	—	—	50	—	—	25	—	—	50	mV pk	
INHIBIT PIN CURRENT	UNIT INHIBITED	—	0.1	1.0	—	0.1	1.0	—	0.1	1.0	—	0.1	1.0	mA	

Notes:

1. Load fault conditions are measured with a resistive load.
2. Short circuit is measured with a 10 m W (±10%) load.
3. Time to settle to within 1% of Vout.
4. Transition time > 10 µs
5. Output voltage for dual output models is measured at half load.

6. The maximum specification is the total output current/power. Up to 70% of that total is available from either output provided the other output maintains a minimum of 15% the total power used.
7. Cross regulation percentages are for the following conditions:  

+Po = 30% and -Po = 70%	+Po = 10% and -Po = 50%
+Po = 70% and -Po = 30%	+Po = 50% and -Po = 10%

# MOR SERIES 120 WATT

# DC/DC CONVERTERS

Electrical Characteristics: Tc = 25°C, full load, Vin = 28 VDC, free run, unless otherwise specified.

DUAL OUTPUT MODELS		MOR286R3D			MOR289R5D			MOR2812D			MOR2815D			UNITS
PARAMETER	CONDITIONS	MIN	TYP	MAX	MIN	TYP	MAX	MIN	TYP	MAX	MIN	TYP	MAX	
OUTPUT VOLTAGE <sup>5</sup>	+V <sub>OUT</sub>	6.24	6.30	6.36	9.40	9.50	9.60	11.88	12.00	12.12	14.85	15.00	15.15	VDC
	-V <sub>OUT</sub>	6.20	6.30	6.40	9.35	9.50	9.65	11.80	12.00	12.20	14.76	15.00	15.24	
OUTPUT CURRENT <sup>6</sup>	V <sub>IN</sub> = 16 to 40 VDC	—	±8	16	—	±5.53	11.05	—	±4.58	9.16	—	±4.00	8.00	A <sup>6</sup>
OUTPUT POWER	V <sub>IN</sub> = 16 to 40 VDC	—	—	100	—	—	105	—	—	110	—	—	120	W
OUTPUT RIPPLE VOLTAGE +V <sub>OUT</sub> / -V <sub>OUT</sub>	10 kHz - 20 MHz Tc = -55°C to +125°C	—	50	100	—	75	120	—	75	120	—	75	150	mV p-p
	10 kHz - 2 MHz Tc = -55°C to +125°C	—	30	60	—	50	80	—	50	100	—	50	120	
LINE REGULATION V <sub>IN</sub> = 16 to 40 VDC	+V <sub>OUT</sub>	—	25	50	—	25	50	—	25	50	—	25	50	mV
	-V <sub>OUT</sub>	—	50	160	—	50	100	—	50	100	—	50	100	
LOAD REGULATION	+V <sub>OUT</sub>	—	25	50	—	25	50	—	25	50	—	25	50	mV
	-V <sub>OUT</sub>	—	50	200	—	50	200	—	50	200	—	50	200	
CROSS REGULATION <sup>7</sup>	NEGATIVE V <sub>OUT</sub>	—	5	8	—	4	7	—	3	5	—	2	4	%
INPUT VOLTAGE	CONTINUOUS	16	28	40	16	28	40	16	28	40	16	28	40	VDC
	TRANSIENT 120 msec	—	—	50	—	—	50	—	—	50	—	—	50	
INPUT CURRENT	NO LOAD	—	70	140	—	70	140	—	70	140	—	70	140	mA
	FULL LOAD	—	—	4.45	—	—	4.63	—	—	4.72	—	—	5.10	A
	INHIBITED - INH1	—	—	10	—	—	10	—	—	10	—	—	10	mA
	INHIBITED - INH2	—	—	70	—	—	70	—	—	70	—	—	70	
INPUT RIPPLE CURRENT	10 kHz - 20 MHz Tc = -55°C to +125°C	—	—	130	—	—	130	—	—	130	—	—	130	mA p-p
EFFICIENCY		81	83	—	82	84	—	84	86	—	85	87	—	%
LOAD FAULT <sup>1</sup>	POWER DISSIPATION OVERLOAD	—	—	30	—	—	30	—	—	30	—	—	30	W
	SHORT CIRCUIT <sup>2</sup>	—	—	24	—	—	24	—	—	22	—	—	20	
	RECOVERY	—	—	10	—	—	10	—	—	10	—	—	10	ms
	OUTPUT CURRENT TRIP POINT	—	—	20	—	—	14	—	—	11	—	—	10	A
	SHORT CIRCUIT <sup>2</sup>	—	—	19	—	—	13	—	—	10	—	—	9	
STEP LOAD RESP. ± V <sub>OUT</sub>	50% - 100% - 50%	—	—	500	—	—	500	—	—	600	—	—	600	mV pk
	TRANSIENT RECOVERY <sup>3</sup>	—	—	300	—	—	300	—	—	300	—	—	300	
STEP LINE RESP. ± V <sub>OUT</sub>	16 - 40 - 16 VDC	—	—	500	—	—	600	—	—	600	—	—	750	mV pk
	TRANSIENT <sup>4</sup>	—	—	300	—	—	300	—	—	300	—	—	300	
START-UP	TIME	—	—	10	—	—	10	—	—	10	—	—	10	ms
	OVERSHOOT	—	—	50	—	—	50	—	—	50	—	—	50	mV pk
INHIBIT PIN CURRENT	UNIT INHIBITED	—	0.1	1.0	—	0.1	1.0	—	0.1	1.0	—	0.1	1.0	mA

Notes:

1. Load fault conditions are measured with a resistive load.
2. Short circuit is measured with a 10 m W (±10%) load.
3. Time to settle to within 1% of Vout.
4. Transition time > 10 μs
5. Output voltage for dual output models is measured at half load.

6. The maximum specification is the total output current/power. Up to 70% of that total is available from either output provided the other output maintains a minimum of 15% the total power used.

7. Cross regulation percentages are for the following conditions:  
 +Po = 30% and -Po = 70%                      +Po = 10% and -Po = 50%  
 +Po = 70% and -Po = 30%                      +Po = 50% and -Po = 10%

# DC/DC CONVERTERS

# MOR SERIES 120 WATT

## PIN DESCRIPTIONS AND FUNCTIONS

### PIN OUT

Pin	Single Output	Dual Output
1	Positive Input	Positive Input
2	Input Common	Input Common
3	Trim	Case
4	Inhibit 1 (INH1)	Inhibit 1 (INH1)
5	Sync Out	Sync Out
6	Sync In	Sync In
7	Positive Output	Positive Output
8	Output Common	Output Common
9	Sense Return	Negative Output
10	Positive Sense	Trim
11	Share	Share
12	Inhibit 2 (INH2)	Inhibit 2 (INH2)

### POSITIVE INPUT AND INPUT COMMON

Steady state voltage range is 16 to 40 VDC. Transient range is 40 to 50 V for a maximum of 120 msec. Low voltage lockout prevents the units from operating below approximately 15.5 VDC input voltage to keep system current levels smooth, especially during initialization or re-start operations. All models include a soft-start function to prevent large current draw and minimize overshoot.

### CASE AND EXTERNAL INPUT FILTERS

Internal 500 V capacitors are connected between the case and input common and between the case and output common. See Figure 1.

Interpoint's FME filters are recommended to meet CE03 requirements for reflected input line current. When using an external input filter it is important that the case of the filter and the case of the converter be connected through as low as an impedance as possible. Direct connection of the baseplates to chassis ground is the best connection. If connected by a single trace, the trace should be as wide as it is long.

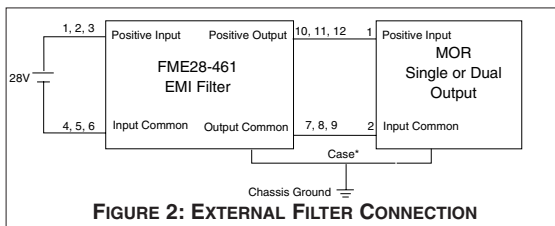

FIGURE 2: EXTERNAL FILTER CONNECTION

### TRIM

Both single and dual output models include a trim function. Output voltage can be trimmed from 60% up to 110% of nominal V out. When trimming up, do not exceed the maximum output power. When trimming down, do not exceed the maximum output current.

#### Trim Formulas

$$\text{Trim Up: } \alpha = \frac{V_o}{V_{o \text{ nominal}}}, 1.0 \leq \alpha \leq 1.1$$

$$R_T (\text{k}\Omega) = \left( \frac{V_o}{2.5} - 1 \right) \cdot 20 - 50$$

Example:  $V_{o \text{ nominal}} = 5.0$ ,  $V_o = 5.25$ ,  $\alpha = 1.05$ ,  $R_T = 390 \text{ k}\Omega$

$$\text{Trim Down: } \alpha = \frac{V_o}{V_{o \text{ nominal}}}, 0.6 \leq \alpha \leq 1.0$$

$$R_T (\text{k}\Omega) = \frac{50 \cdot \alpha - 30}{1 - \alpha}$$

Example:  $V_{o \text{ nominal}} = 5.0$ ,  $V_o = 4.5$ ,  $\alpha = 0.9$ ,  $R_T = 150 \text{ k}\Omega$

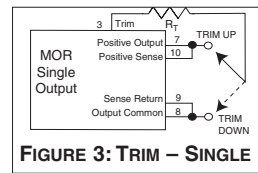

FIGURE 3: TRIM - SINGLE

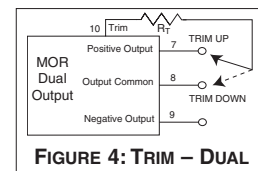

FIGURE 4: TRIM - DUAL

On dual models the positive output is regulated and the negative output is transformer coupled (cross-regulated) to the positive output. When trimming the duals, both output voltages will be adjusted equally.

### INHIBIT 1 AND 2

Two inhibit terminals disable switching, resulting in no output and very low quiescent input current. The two inhibit pins allow access to an inhibit function on either side of the isolation barrier to help maintain isolation.

An open collector is required for interfacing with both of the inhibit pins. Applying an open-collector TTL logic low to either inhibit pin will inhibit the converter. Applying an open collector TTL logic high or leaving the pins open will enable the converter. Inhibit 1 is referenced to Input Common, while Inhibit 2 is referenced to Sense Return on the output side.

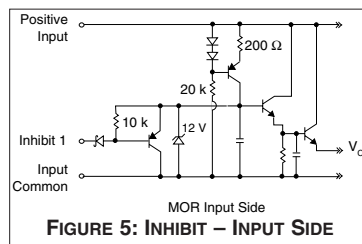

FIGURE 5: INHIBIT - INPUT SIDE

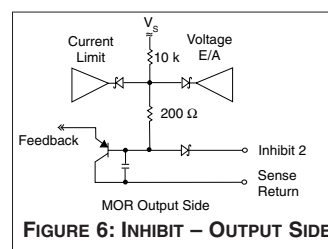

FIGURE 6: INHIBIT - OUTPUT SIDE

The open circuit voltage for Inhibit 1 is 13 V and for Inhibit 2 it is 8 V. Float the inhibit pin(s) if not used. The required logic low voltage level is 0.2 V maximum.

# MOR SERIES 120 WATT

# DC/DC CONVERTERS

## SYNC IN AND SYNC OUT

The MOR converters can be synchronized to the system clock by applying a TTL compatible sync signal to the Sync In pin. Sync Out can be used to synchronize other components to the MOR converter's switching frequency.

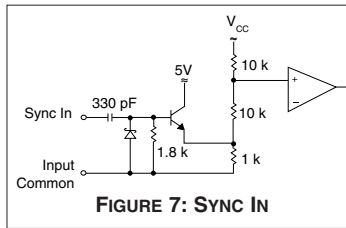

FIGURE 7: SYNC IN

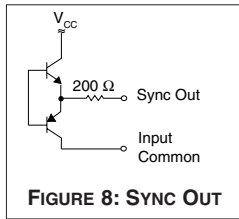

FIGURE 8: SYNC OUT

The frequency range for external synchronization is 525 to 625 kHz. The requirements for an external signal are 15% to 50% duty cycle,  $0 \leq L \leq 0.8$  V and  $4.5 \leq H \leq 9$  V. Both Sync In and Sync Out are referenced to input common. Sync In should be grounded to input common if not used.

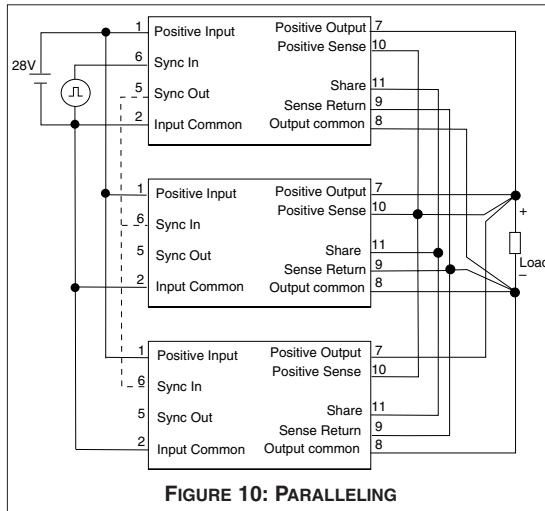

FIGURE 10: PARALLELING

## POSITIVE SENSE, SENSE RETURN

A special remote sensing feature maintains the desired output voltage at the load. When this feature is not used, connect the sense lines to their respective output terminals. Remote sensing is available on single output models only. See Figure 12. Do not exceed 110% of  $V_{out}$  and maximum output power.

## SHARE (PARALLELING)

By using the Share pin, up to five single or dual converters may be paralleled for a total output power of over 500 watts (90%  $P_{out}$  / converter, max.). The converters will share within 10% of each other at 25 to 90% rated power. MOR converters feature true n+1 redundancy for reliability in critical applications. See Figure 9 for the proper connections.

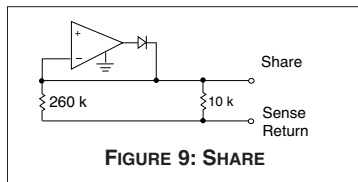

FIGURE 9: SHARE

All Positive Outputs and Positive Senses should be connected to a common point. All Negative Outputs and Sense Returns should be connected to a common point. The Share pin is referenced to Sense Return. Leave the share pin floating (unconnected) if not used.

## POSITIVE OUTPUT, NEGATIVE OUTPUT AND OUTPUT COMMON

Output current is limited to 125% of maximum specified current under short circuit or load fault conditions.

Single output models operate from no load to full load. Dual output models with balanced loads operate from no load to full load. For dual models with unbalanced loads, at least 10% of the total output power must be drawn from the positive output at all times, however, the negative output does not require a minimum load. See note 7, cross regulation, under the Electrical Characteristics Tables. Dual outputs may be "stacked" to double the output voltage.

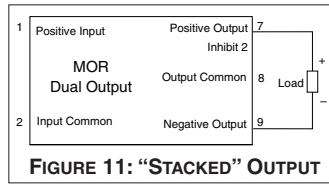

FIGURE 11: "STACKED" OUTPUT

## TYPICAL CONNECTIONS

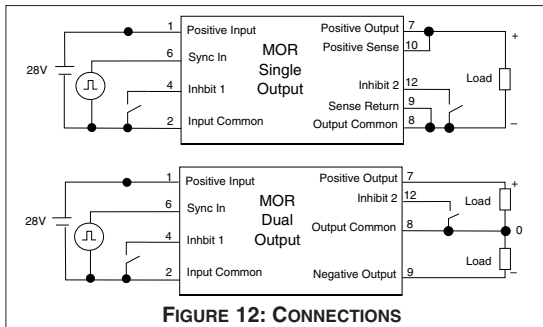

FIGURE 12: CONNECTIONS

# DC/DC CONVERTERS

# MOR SERIES 120 WATT

PIN OUT	Pin	Single Output	Dual Output
	1	Positive Input	Positive Input
	2	Input Common	Input Common
	3	Trim	Case
	4	Inhibit 1 (INH1)	Inhibit 1 (INH1)
	5	Sync Out	Sync Out
	6	Sync In	Sync In
	7	Positive Output	Positive Output
	8	Output Common	Output Common
	9	Sense Return	Negative Output
	10	Positive Sense	Trim
	11	Share	Share
	12	Inhibit 2 (INH2)	Inhibit 2 (INH2)

Angled corner and cover marking indicate pin one for cases U and V. Cover marking indicates pin one for cases W, Y, and Z.

**TOP VIEW**  
MOR  
(Pin side, marked side)

Outline shown is case U, pin out is the same for all cases. Also available: flanged – leads bent down (case V); tabbed – leads bent up (case W), short leads (case Y), and leads bent down (case Z). See Figures 55 through 60 for dimensions.

**FIGURE 13: PIN OUT TOP VIEW**

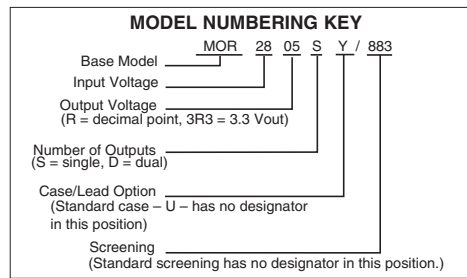

STANDARD MICROCIRCUIT DRAWING (SMD)	MOR SERIES SIMILAR PART
5962-9954401HXC	MOR283R3S/883
5962-9954801HXC	MOR2805S/883
5962-9954501HXC	MOR286R3S/883
5962-9954601HXC	MOR289R5S/883
5962-9954901HXC	MOR2812S/883
5962-9955001HXC	MOR2815S/883
5962-9956401HXC	MOR283R3D/883
5962-9956101HXC	MOR2805D/883
5962-9956501HXC	MOR286R3D/883
5962-9956601HXC	MOR289R5D/883
5962-9956201HXC	MOR2812D/883
5962-9956301HXC	MOR2815D/883

For exact specifications for an SMD product, refer to the SMD drawing. In the SMD number the "X" in the "HXC" suffix corresponds to case U, case V=U, case W=T, case Y=Y, and case Z=Z. SMDs can be downloaded from: <http://www.dscc.dla.mil/programs/smcr>

Typical Performance Curves: 25°C Tc, 28 VDC Vin, 100% load, 20 MHz BW, free run, unless otherwise specified.

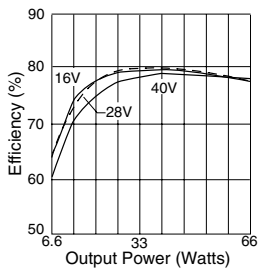

**FIGURE 14**

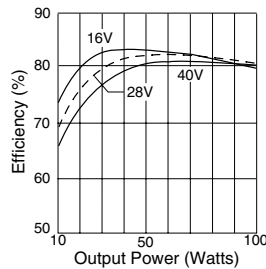

**FIGURE 15**

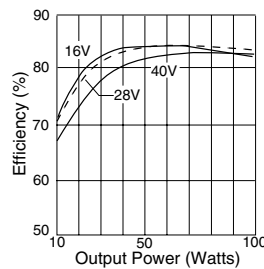

**FIGURE 16**

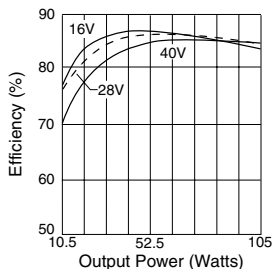

**FIGURE 17**

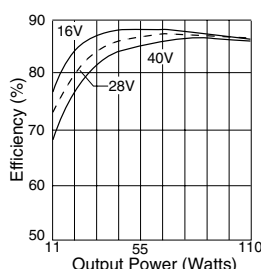

**FIGURE 18**

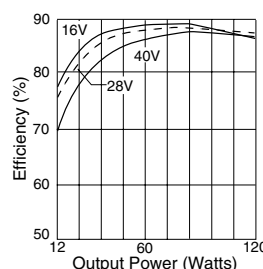

**FIGURE 19**

# MOR SERIES 120 WATT

# DC/DC CONVERTERS

Typical Performance Curves: 25°C Tc , 28 VDC Vin, 100% load, 20 MHz BW, free run, unless otherwise specified.

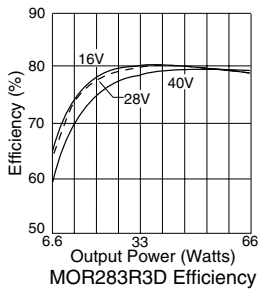

FIGURE 20

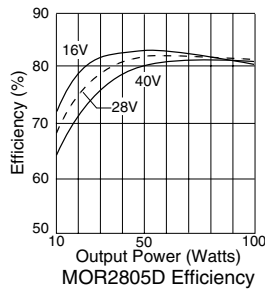

FIGURE 21

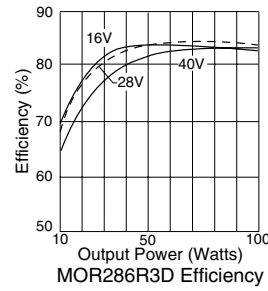

FIGURE 22

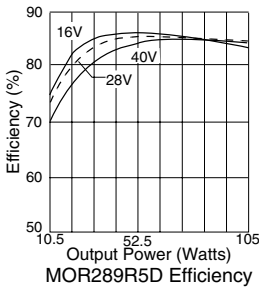

FIGURE 23

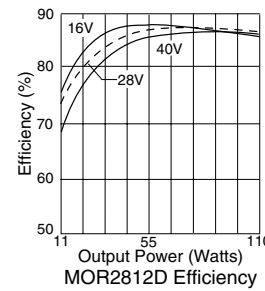

FIGURE 24

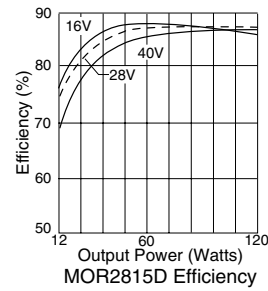

FIGURE 25

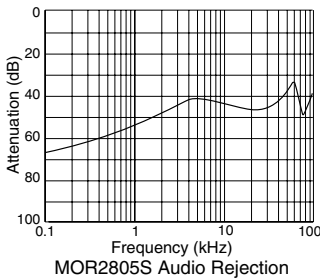

FIGURE 26

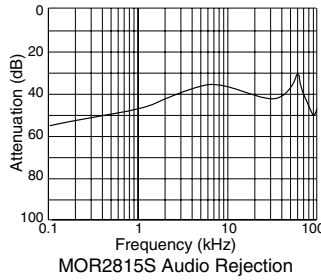

FIGURE 27

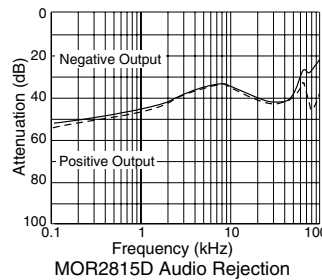
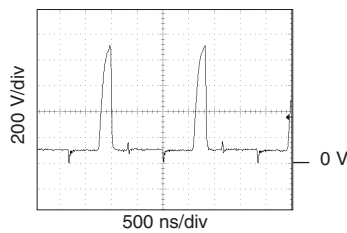
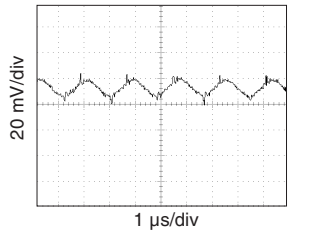

FIGURE 28



Representative of all models  
MOR2812D Sync Out  
FIGURE 29



MOR2805S Output Ripple (Vout)  
FIGURE 30

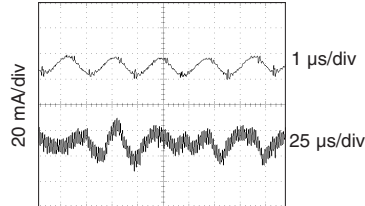

MOR2805S Input Ripple Current (Iin)  
FIGURE 31



# DC/DC CONVERTERS

# MOR SERIES 120 WATT

Typical Performance Curves: 25°C Tc , 28 VDC Vin, 100% load, 20 MHz BW, free run, unless otherwise specified.

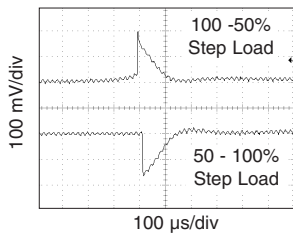

MOR2805S Step Load Response  
**FIGURE 32**

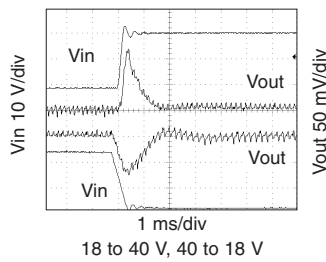

MOR2805S Step Line Response  
**FIGURE 33**

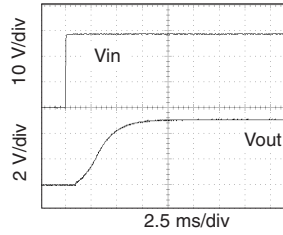

All combinations of line and load  
MOR2805S Turn On Response  
**FIGURE 34**

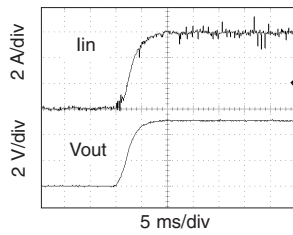

With and without 470 μF cap. load  
MOR2805S Inhibit Release Inrush Current  
**FIGURE 35**

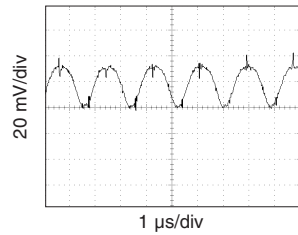

MOR2815S Output Ripple (Vout)  
**FIGURE 36**

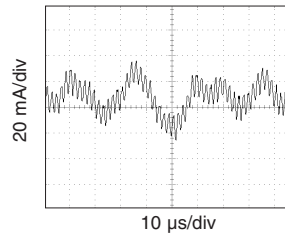

MOR2815S Input Ripple (lin)  
**FIGURE 37**

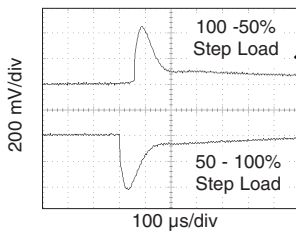

MOR2815S Step Load Response  
**FIGURE 38**

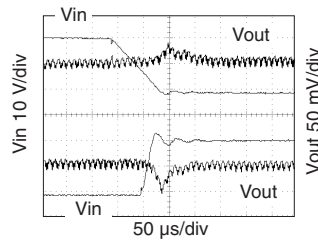

MOR2815S Step Line Response  
**FIGURE 39**

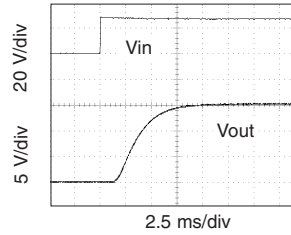

All combinations of line and load  
MOR2815S Turn On Response  
**FIGURE 40**

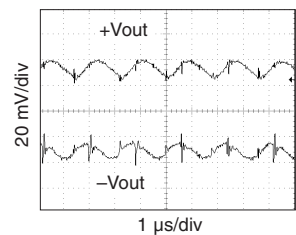

80% load each output  
MOR2805D Output Ripple (±Vout)  
**FIGURE 41**

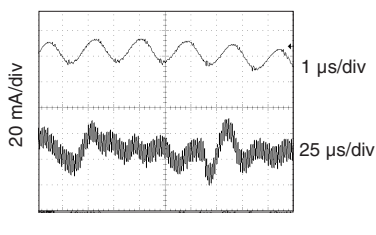

80% load each output  
MOR2805D Input Ripple (lin)  
**FIGURE 42**

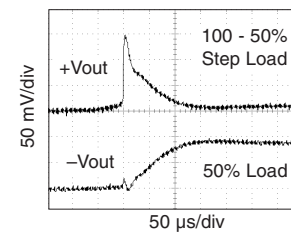

MOR2805D Step Load Response  
**FIGURE 43**

# MOR SERIES 120 WATT

# DC/DC CONVERTERS

Typical Performance Curves: 25°C Tc, 28 VDC Vin, 100% load, 20 MHz BW, free run, unless otherwise specified.

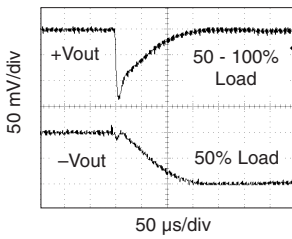

MOR2805D Step Load Response  
**FIGURE 44**

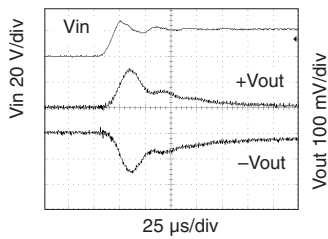

18 to 40 V, 80% load each output  
MOR2805D Step Line Response  
**FIGURE 45**

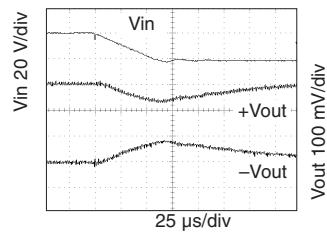

40 to 18 V, 80% load each output  
MOR2805D Step Line Response  
**FIGURE 46**

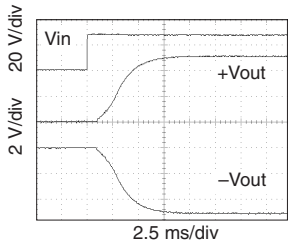

80% load each output  
MOR2805D Turn On Response  
**FIGURE 47**

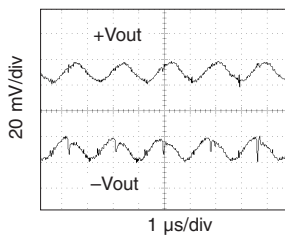

MOR2812D Output Ripple ( $\pm$ Vout)  
**FIGURE 48**

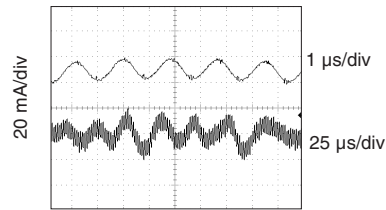

MOR2812D Input Ripple (Iin)  
**FIGURE 49**

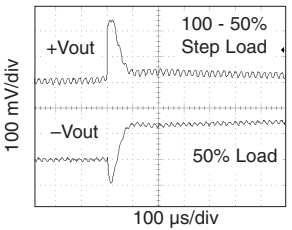

MOR2812D Step Load Response  
**FIGURE 50**

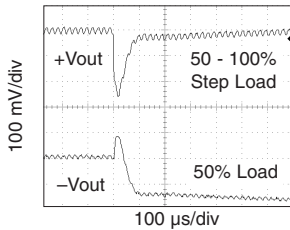

MOR2812D Step Load Response  
**FIGURE 51**

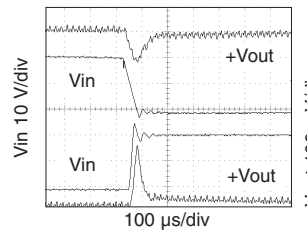

18 to 40 V, 40 to 18 V  
MOR2812D Step Line Response  
**FIGURE 52**

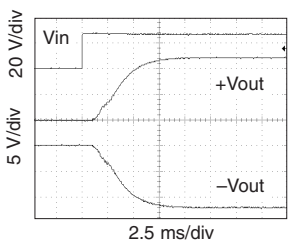

MOR2812D Turn On Response  
**FIGURE 53**

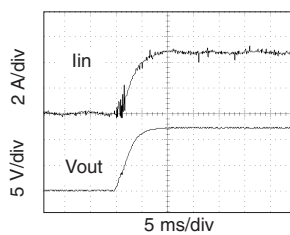

MOR2812D Inhibit Release Inrush Current  
**FIGURE 54**

# DC/DC CONVERTERS

# MOR SERIES 120 WATT

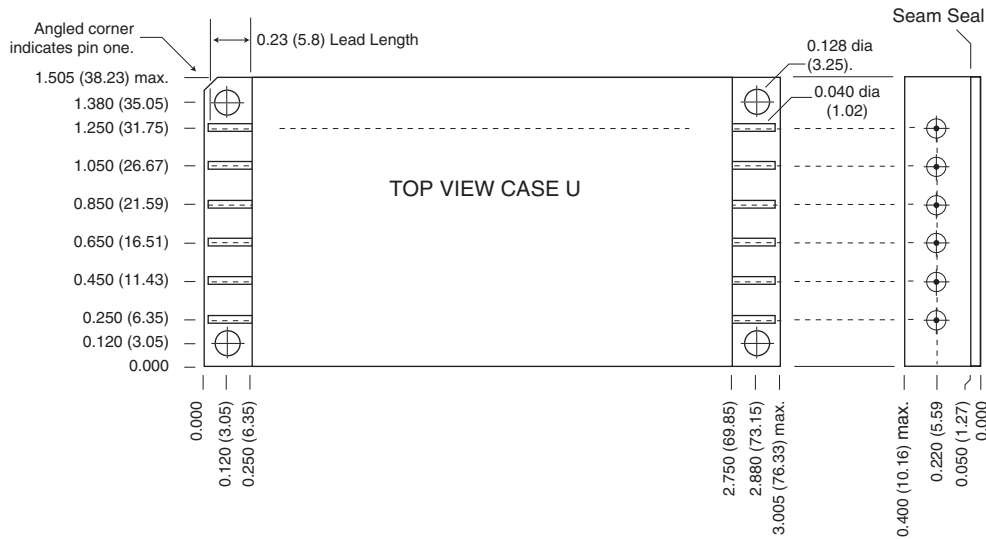

**Materials**

Header Cold Rolled Steel/Nickel/Gold  
 Cover Kovar/Nickel  
 Pins #52 alloy/Gold  
 compression glass seal

**Case dimensions in inches (mm)**

Tolerance  $\pm 0.005$  (0.13) for three decimal places  
 $\pm 0.01$  (0.2) for two decimal places  
 unless otherwise specified

**CAUTION**

Heat from reflow or wave soldering may damage the device. Solder pins individually with heat application not exceeding 300°C for 10 seconds per pin.

FIGURE 55

**MOR SERIES  
120 WATT**

**DC/DC CONVERTERS**

**PIN-SIDE VIEW CASE V\***  
 Flanged case, down leaded)  
 \*Requires case option designator added to model number: MOR2805SV

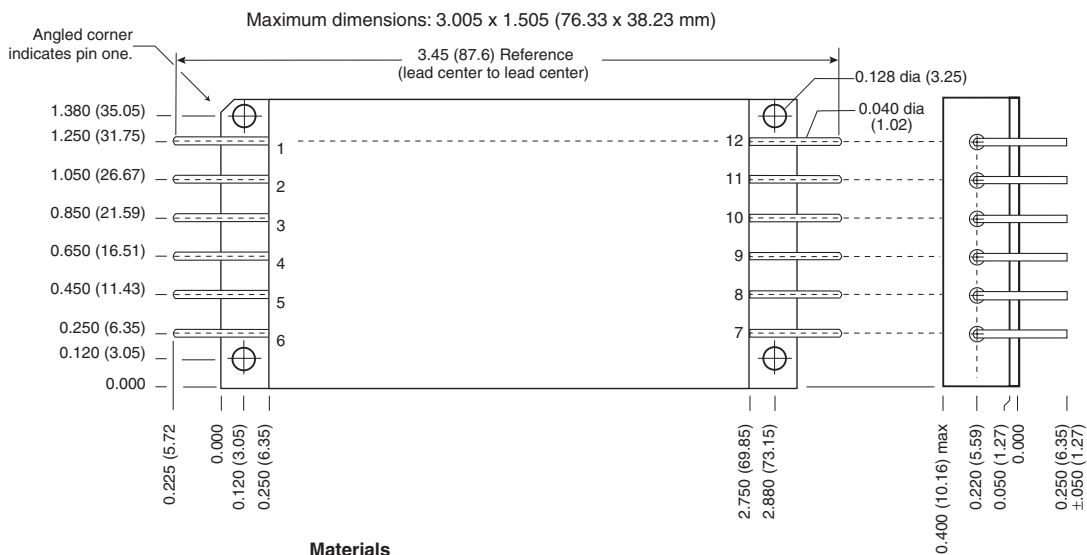

**Materials**

Header Cold Rolled Steel/Nickel/Gold  
 Cover Kovar/Nickel  
 Pins #52 alloy/Gold  
 compression glass seal

**Case dimensions in inches (mm)**

Tolerance ±0.005 (0.13) for three decimal places  
 ±0.01 (0.2) for two decimal places  
 unless otherwise specified

**CAUTION**

Heat from reflow or wave soldering may damage the device. Solder pins individually with heat application not exceeding 300°C for 10 seconds per pin.

**FIGURE 56**

# DC/DC CONVERTERS

# MOR SERIES 120 WATT

PIN-SIDE VIEW CASE W\*  
(Tabbed case, up-leaded)

\*Requires case option designator added to model number: MOR2805SW

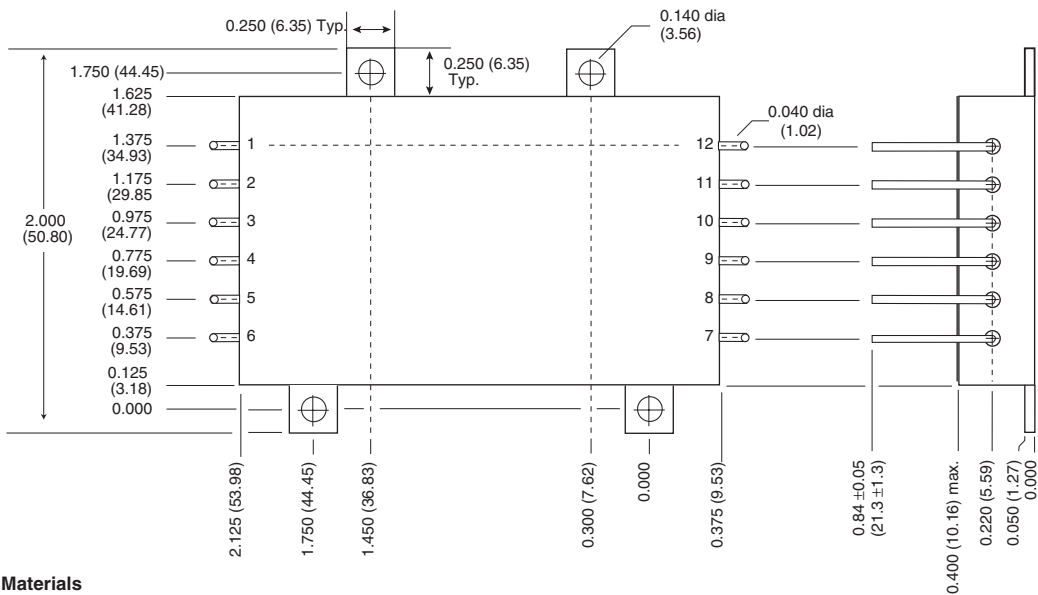

**Materials**

- Header Cold Rolled Steel/Nickel/Gold
- Cover Kovar/Nickel
- Pins #52 alloy/Gold  
compression glass seal

**Case dimensions in inches (mm)**

- Tolerance ±0.005 (0.13) for three decimal places
- ±0.01 (0.2) for two decimal places
- unless otherwise specified

**CAUTION**

Heat from reflow or wave soldering may damage the device. Solder pins individually with heat application not exceeding 300°C for 10 seconds per pin.

Lead Detail

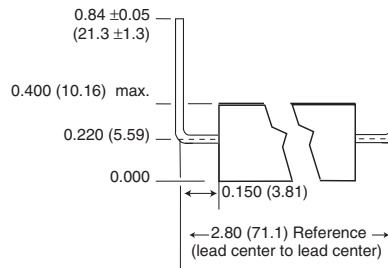
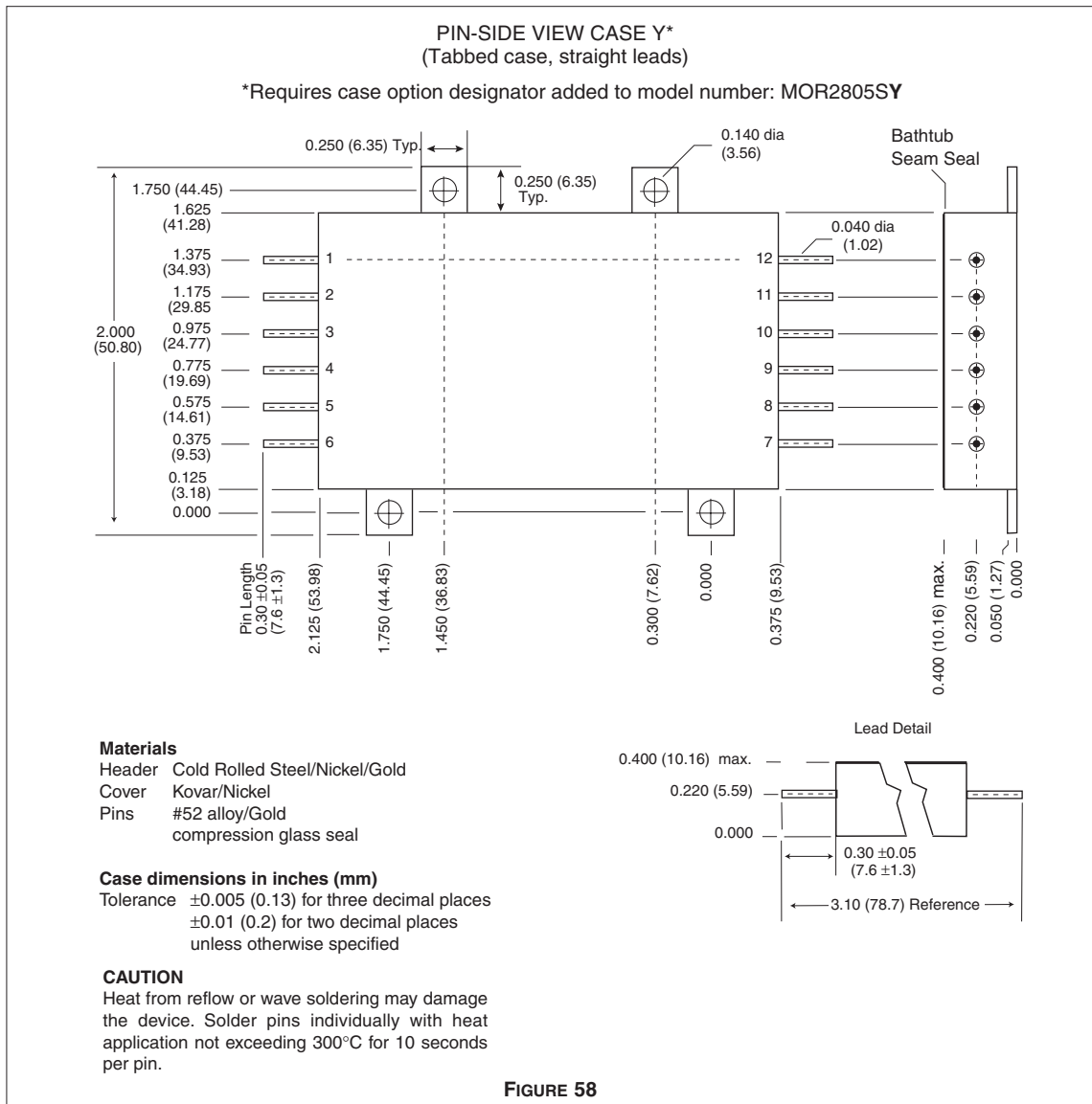

FIGURE 57

**MOR SERIES  
120 WATT**

**DC/DC CONVERTERS**



# DC/DC CONVERTERS

# MOR SERIES 120 WATT

## PIN-SIDE VIEW CASE Z\* (Tabbed case, down-leaded)

\*Requires case option designator added to model number: MOR2805SZ

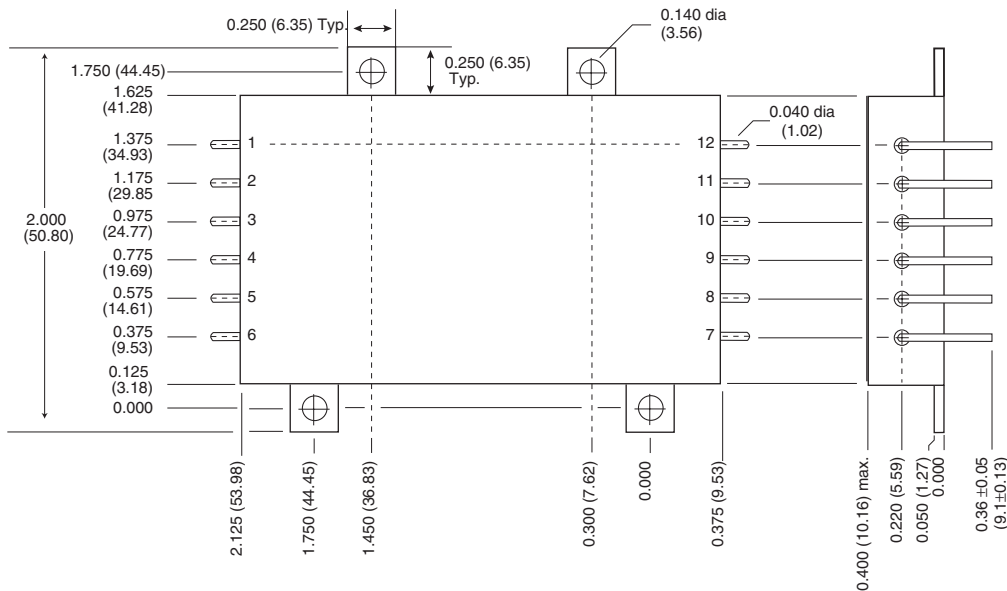

### Materials

Header Cold Rolled Steel/Nickel/Gold  
Cover Kovar/Nickel  
Pins #52 alloy/Gold  
compression glass seal

### Case dimensions in inches (mm)

Tolerance  $\pm 0.005$  (0.13) for three decimal places  
 $\pm 0.01$  (0.2) for two decimal places  
unless otherwise specified

### CAUTION

Heat from reflow or wave soldering may damage the device. Solder pins individually with heat application not exceeding 300°C for 10 seconds per pin.

### Lead Detail

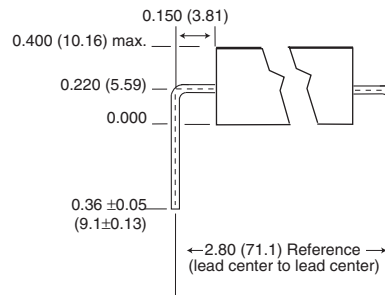

FIGURE 59

**MOR SERIES  
120 WATT**

**DC/DC CONVERTERS**

**ENVIRONMENTAL SCREENING**

<b>TEST</b>	<b>125°C STANDARD</b>	<b>125°C /ES</b>	<b>/883 (Class H)*</b>
PRE-CAP INSPECTION 25°C Method 2017, 2032	yes	yes	yes
TEMPERATURE CYCLE (10 times) Method 1010, Cond. C, -65°C to 150°C Method 1010, Cond. B, -55°C to 125°C	no no	no yes	yes no
CONSTANT ACCELERATION 25°C Method 2001, 3000 g Method 2001, 500 g	no no	no yes	yes no
BURN-IN Method 1015, 160 hours at 125°C 96 hours at 125°C case (typical)	no no	no yes	yes no
FINAL ELECTRICAL TEST MIL-PRF-38534, Group A Subgroups 1 through 6: -55°C, +25°C, +125°C Subgroups 1 and 4: +25°C case	no yes	no yes	yes no
HERMETICITY TESTING 25°C Fine Leak, Method 1014, Cond. A Gross Leak, Method 1014, Cond. C Gross Leak, Dip (1 x 10 <sup>-3</sup> )	no no yes	yes yes no	yes yes no
FINAL VISUAL INSPECTION 25°C Method 2009	yes	yes	yes

Test methods are referenced to MIL-STD-883 as determined by MIL-PRF-38534.

**Contact Information:**

[www.interpoint.com](http://www.interpoint.com)

Interpoint Headquarters USA  
Phone: 1-800-822-8782  
+425-882-3100  
Email: [power@intp.com](mailto:power@intp.com)

Interpoint UK  
Phone: +44-1252-872266  
Email: [poweruk@intp.com](mailto:poweruk@intp.com)

Interpoint France  
Phone: +33-134285455  
Email: [powerfr@intp.com](mailto:powerfr@intp.com)