

SI-3000B Series

5-Terminal, Multi-Function, Full-Mold, Low Dropout Voltage Dropper Type

■Features

- Compact full-mold package (equivalent to TO220)
- Output current: 0.27A
- Low dropout voltage: $V_{DIF} \leq 0.5V$ (at $I_o = 0.27A$)
- Output ON/OFF control terminal is compatible with LS-TTL. (It may be directly driven by LS-TTL or standard CMOS logic.)
- Built-in foldback overcurrent, thermal protection circuits
- Accurate overcurrent protection starting current
 SI-3157B : 0.3 to 0.7A ($V_{IN} = 18V$)
 SI-3025B : 0.3 to 0.7A (When $V_{IN} = 18V$, at $V_o = 15.7V$)
 0.3 to 0.75A (When $V_{IN} = 18V$, at $V_o = 11.7V$)
- Variable output voltage type (SI-3025B) also available



■Applications

- For BS and CS antenna power supplies
- Electronic equipment

■Absolute Maximum Ratings

($T_a = 25^\circ C$)

Parameter	Symbol	Ratings	Unit
DC Input Voltage	V_{IN}	35	V
Voltage of Output Control Terminal	V_c	V_{IN}	V
DC Output Current	I_o	0.27 ^{*1}	A
Power Dissipation	P_{D1}	14(With infinite heatsink)	W
	P_{D2}	1.5(Without heatsink, stand-alone operation)	W
Junction Temperature	T_j	-40 to +125	$^\circ C$
Ambient Operating Temperature	T_{op}	-30 to +100	$^\circ C$
Storage Temperature	T_{stg}	-40 to +125	$^\circ C$
Thermal Resistance (junction to case)	$R_{th(j-c)}$	7.0	$^\circ C/W$
Thermal Resistance (junction to ambient air)	$R_{th(j-a)}$	66.7(Without heatsink, stand-alone operation)	$^\circ C/W$

■Electrical Characteristics

(Ta=25°C unless otherwise specified)

Parameter	Symbol	Ratings						Unit	
		SI-3157B			SI-3025B				
		min.	typ.	max.	min.	typ.	max.		
Input Voltage	V _{IN}	*2		27*1	6*2,6		27*1	V	
Output Voltage (SI-3025B: Reference Voltage)	V _O (V _{REF})	14.92	15.70	16.48	2.448	2.550	2.652	V	
	Conditions	V _{IN} =18V, I _O =0.2A			V _{IN} =V _O +3V, I _O =0.2A				
Dropout Voltage	V _{DIF}			0.5			0.5	V	
	Conditions	I _O ≤0.27A			I _O ≤0.27A				
Line Regulation	ΔV _{OLINE}		30	90			10	mV (3025B: mV/V)	
	Conditions	V _{IN} =17 to 27V, I _O =0.2A			V _{IN} =(V _O +1) to 27V, I _O =0.27A				
Load Regulation	ΔV _{OLOAD}		120	300			10	mV (3025B: mV/V)	
	Conditions	V _{IN} =18V, I _O =0 to 0.27A			V _{IN} =V _O +3V, I _O =0 to 0.27A				
Temperature Coefficient of Output Voltage (SI-3025B: Temperature Coefficient of Reference Voltage)	ΔV _O /ΔT _a (ΔV _{REF} /ΔT _a)		±1.5			±0.5		mV/°C	
	Conditions	V _{IN} =18V, I _O =5mA, T _J =0 to 100°C			V _{IN} =V _O +3V, I _O =5mA, T _J =0 to 100°C				
Ripple Rejection	R _{REJ}		54			54		dB	
	Conditions	V _{IN} =18V, f=100 to 120Hz			V _{IN} =V _O +3V, f=100 to 120Hz				
Quiescent Circuit Current	I _q		3	10		3	10	mA	
	Conditions	V _{IN} =18V, I _O =0A			V _{IN} =V _O +3V, I _O =0A				
Overcurrent Protection Starting Current*3,4	I _{S1}	0.3		0.7	0.3		0.75	A	
	Conditions	V _{IN} =18V			V _{IN} =18V, at V _O =11.7V				
					0.3		0.7		
	Conditions				V _{IN} =18V, at V _O =15.7V				
V _c Terminal*5	Control Voltage (Output ON)	V _c . IH	2.0		2.0			V	
	Control Voltage (Output OFF)	V _c . IL			0.8		0.8		
	Control Current (Output ON)	I _c . IH			20			20	μA
		Conditions	V _c =2.7V			V _c =2.7V			
	Control Current (Output OFF)	I _c . IL			-0.3			-0.3	mA
		Conditions	V _c =0.4V			V _c =0.4V			

*1: V_{IN(max)} and I_{O(max)} are restricted by the relation P_{D(max)}=(V_{IN}-V_O)•I_O=14(W).

*2: Refer to the dropout voltage.(Refer to Setting DC Input Voltage on page 7.)

*3: I_{S1} is specified at -5(%) drop point of output voltage V_O on the condition that V_{IN}=V_O+3V, I_O=0.2A.

*4: A foldback type overcurrent protection circuit is built into the IC regulator. Therefore, avoid using it for the following applications as it may cause starting errors:

- (1) Constant current load (2) Plus/minus power (3) Series power (4) V_O adjustment by raising ground voltage

*5: Output is ON even when output control terminal V_c is open. Each input level is equivalent to LS-TTL. Therefore, it may be directly driven by an LS-TTL circuit.

*6. When setting output voltage to 5V or less, input voltage needs to be set to 6V or over to operate stably.

■External Dimensions

(unit:mm)

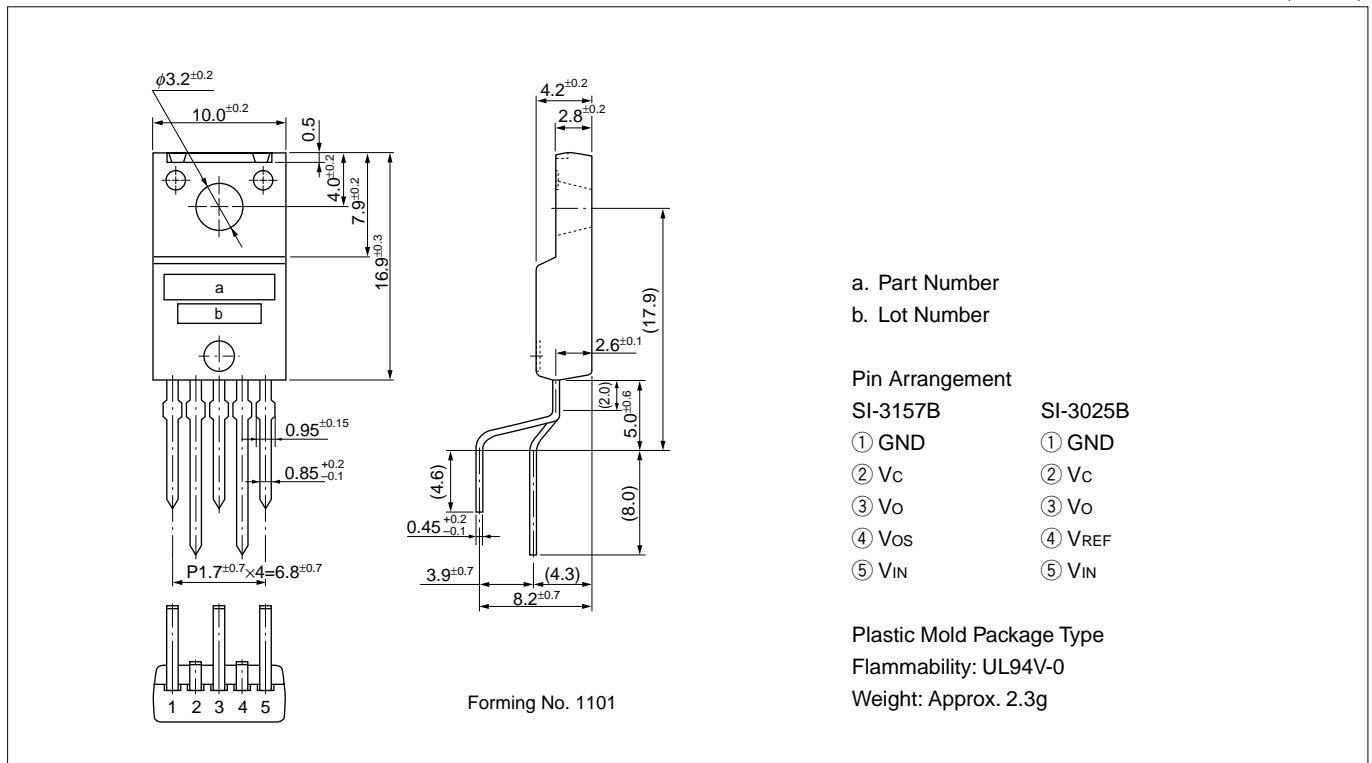

■Block Diagram

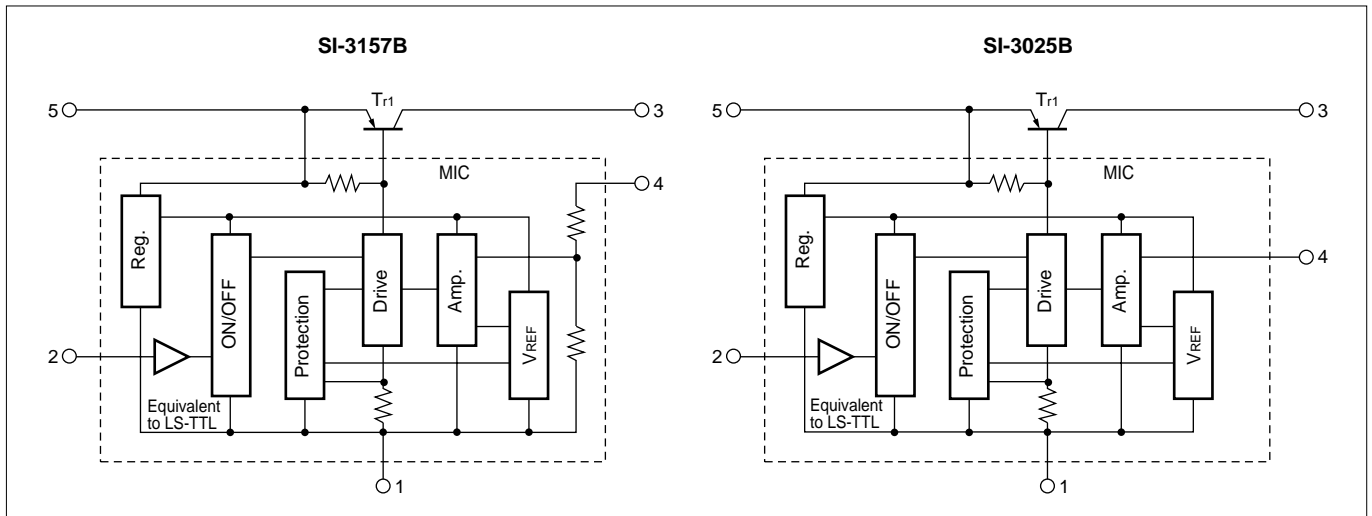

■Standard External Circuit

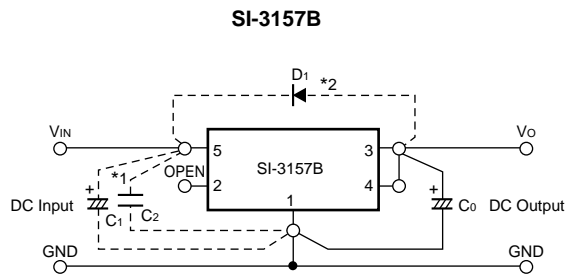

- C_0 : Output capacitor (47 to 100 μ F)
- *1 C_1 } Oscillation prevention capacitor
- C_2 } (C_1 : Approx. 47 μ F, C_2 : 0.33 μ F)

These capacitors are required if the input line is inductive and in the case of long wiring. Tantalum capacitors are recommended for C_1 and C_0 , particularly at low temperatures.

- *2 D_1 : Protection diode

This diode is required for protection against reverse biasing of the input and output. Sanken EU2Z is recommended.

- *3 R_1 } External resistor for setting output voltage

- R_2 } Relationship between output voltage V_o and external resistors R_1 and R_2 is as follows.

$$V_o = V_{REF} \cdot \left(1 + \frac{R_1}{R_2} \right) \quad (V_{REF} = 2.55V(\text{typ.}))$$

R_2 must be 2.55k Ω for stable operation.

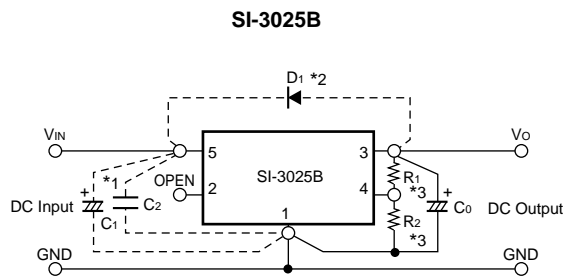

■ T_a - P_d Characteristics

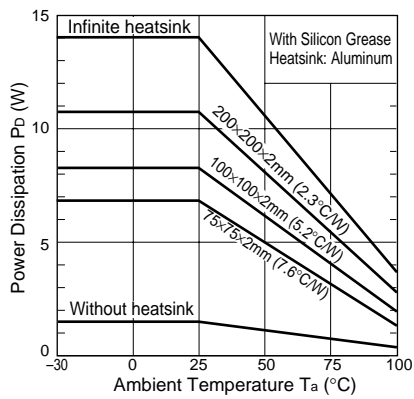

$$P_D = I_o \cdot [V_{IN}(\text{mean}) - V_o]$$

■Typical Characteristics (at $V_o=15.7V$ for SI3025B)

($T_a=25^\circ C$)

I_o vs. V_{DIF} Characteristics

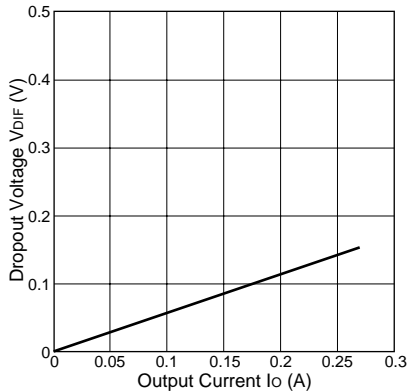

Temperature Coefficient of Output Voltage(SI-3157B)

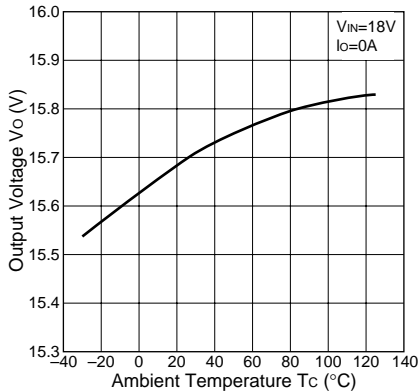

Output Voltage(SI-3157B)

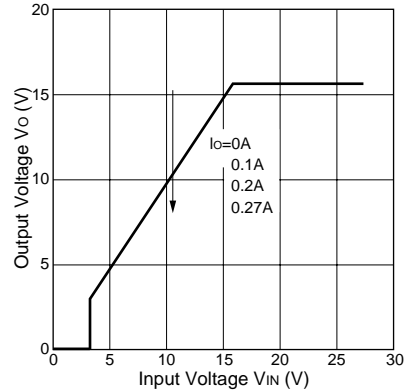

Line Regulation

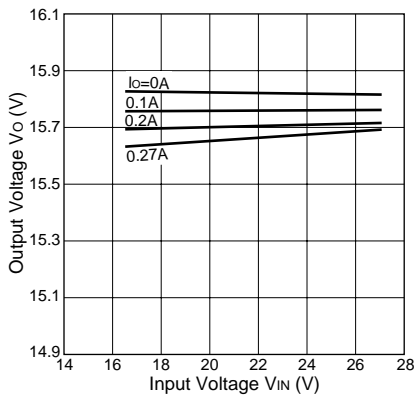

Load Regulation

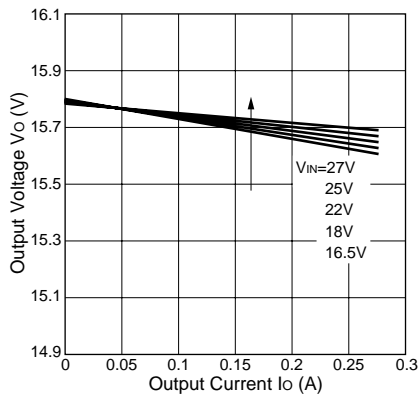

Overcurrent Protection Characteristics(SI-3157B)

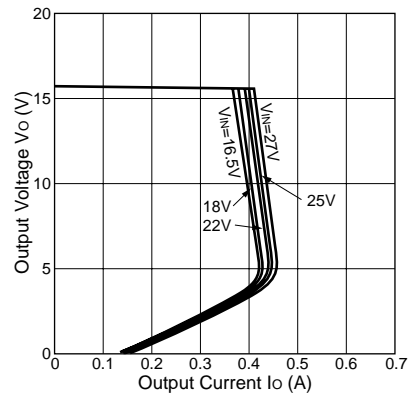

Output ON/OFF Control

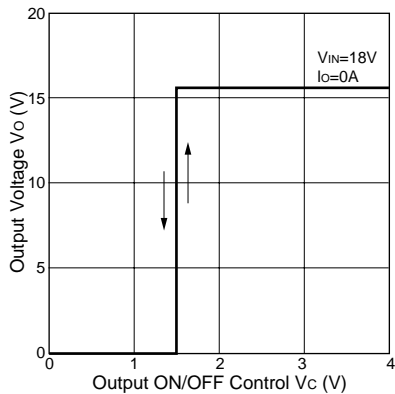

Thermal Protection Characteristics

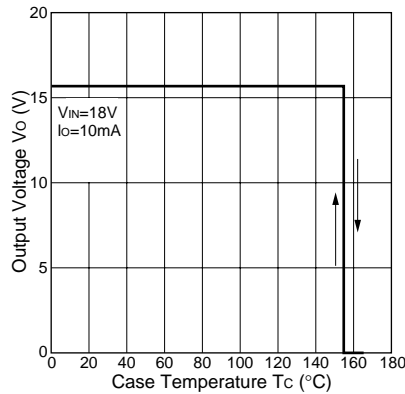

Note on Thermal Protection:

The thermal protection circuit is intended for protection against heat during instantaneous short-circuiting. Its operation is not guaranteed for continuous heating condition such as short-circuiting over extended periods of time.