

Features

- Built using the advantages and compatibility of CMOS and IXYS HDMOS™ processes
- Latch-Up Protected
- High Peak Output Current: 4A Peak
- Wide Operating Range: 4.5V to 25V
- Ability to Disable Output under Faults
- High Capacitive Load
Drive Capability: 1800pF in <15ns
- Matched Rise And Fall Times
- Low Propagation Delay Time
- Low Output Impedance
- Low Supply Current
- Two identical drivers in single chip

Applications

- Driving MOSFETs and IGBTs
- Limiting di/dt under Short Circuit
- Motor Controls
- Line Drivers
- Pulse Generators
- Local Power ON/OFF Switch
- Switch Mode Power Supplies (SMPS)
- DC to DC Converters
- Pulse Transformer Driver
- Class D Switching Amplifiers

General Description

The IXDD404 is comprised of two 4 Amp CMOS high speed MOSFET drivers. Each output can source and sink 4 A of peak current while producing voltage rise and fall times of less than 15ns to drive the latest IXYS MOSFETs & IGBT's. The input of the driver is compatible with TTL or CMOS and is fully immune to latch up over the entire operating range. Designed with small internal delays, cross conduction/current shoot-through is virtually eliminated in the IXDD404. Improved speed and drive capabilities are further enhanced by very low, matched rise and fall times.

Additionally, each driver in the IXDD404 incorporates a unique ability to disable the output under fault conditions. When a logical low is forced into the Enable input of a driver, both of it's final output stage MOSFETs (NMOS and PMOS) are turned off. As a result, the respective output of the IXDD404 enters a tristate mode and achieves a Soft Turn-Off of the MOSFET/IGBT when a short circuit is detected. This helps prevent damage that could occur to the MOSFET/IGBT if it were to be switched off abruptly due to a dv/dt over-voltage transient.

The IXDD404 is available in the standard 8 pin P-DIP (PI), SOP-8 (SI) and SOP-16 (SI-16) packages.

Figure 1 - Functional Diagram

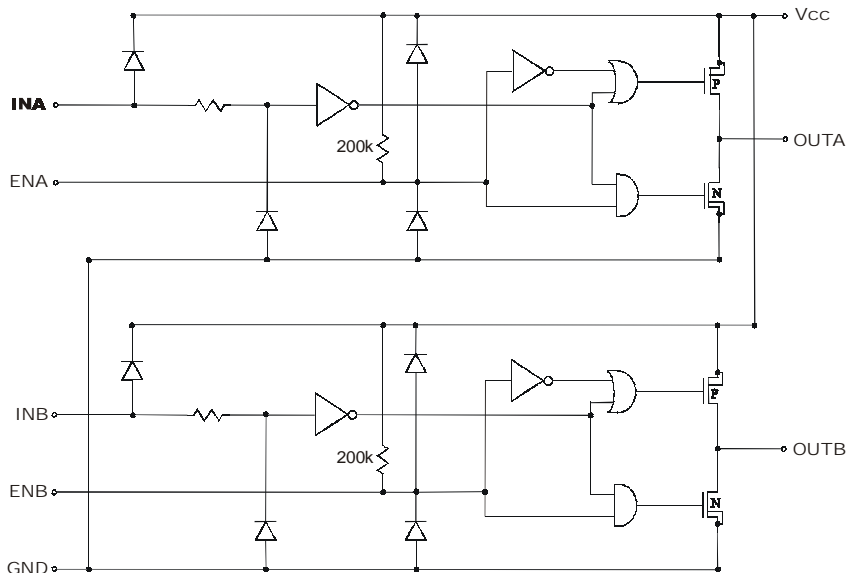

Absolute Maximum Ratings (Note 1)

Parameter	Value
Supply Voltage	25 V
All Other Pins	-0.3 V to $V_{CC} + 0.3$ V
Junction Temperature	150 °C
Storage Temperature	-65 °C to 150 °C
Lead Temperature (10 sec)	300 °C

Operating Ratings

Parameter	Value
Operating Temperature Range	-40 °C to 85 °C
Thermal Impedance (To Ambient)	
8 Pin PDIP (PI) (θ_{JA})	120 °C/W
8 Pin SOIC (SI) (θ_{JA})	110 °C/W
16 Pin SOIC (SI-16) (θ_{JA})	110 °C/W

Electrical Characteristics

Unless otherwise noted, $T_A = 25$ °C, $4.5V \leq V_{CC} \leq 25V$.

All voltage measurements with respect to GND. IXDD404 configured as described in *Test Conditions*. All specifications are for one channel.

Symbol	Parameter	Test Conditions	Min	Typ	Max	Units
V_{IH}	High input voltage		3.5			V
V_{IL}	Low input voltage				0.8	V
V_{IN}	Input voltage range		-5		$V_{CC} + 0.3$	V
I_{IN}	Input current	$0V \leq V_{IN} \leq V_{CC}$	-10		10	μ A
V_{OH}	High output voltage		$V_{CC} - 0.025$			V
V_{OL}	Low output voltage				0.025	V
R_{OH}	Output resistance @ Output high	$I_{OUT} = 10mA, V_{CC} = 18V$		1.5	3	Ω
R_{OL}	Output resistance @ Output Low	$I_{OUT} = 10mA, V_{CC} = 18V$		1.5	3	Ω
I_{PEAK}	Peak output current	V_{CC} is 18V		4		A
I_{DC}	Continuous output current				1	A
V_{EN}	Enable voltage range		-0.3		$V_{CC} + 0.3$	V
V_{ENH}	High En Input Voltage		$2/3 V_{CC}$			V
V_{ENL}	Low En Input Voltage				$1/3 V_{CC}$	V
t_R	Rise time	$C_L = 1800pF, V_{CC} = 18V$	11	12	15	ns
t_F	Fall time	$C_L = 1800pF, V_{CC} = 18V$	12	14	17	ns
t_{ONDLY}	On-time propagation delay	$C_L = 1800pF, V_{CC} = 18V$	33	34	38	ns
t_{OFFDLY}	Off-time propagation delay	$C_L = 1800pF, V_{CC} = 18V$	28	30	35	ns
t_{ENOH}	Enable to output high delay time				30	ns
t_{DOLD}	Disable to output low Disable delay time				30	ns
V_{CC}	Power supply voltage		4.5	18	25	V
I_{CC}	Power supply current	$V_{IN} = 3.5V$ $V_{IN} = 0V$ $V_{IN} = + V_{CC}$		1 0	3 10	mA μ A μ A
R_{EN}	Enable Pull-up Resistor			200		k Ω

Pin Configurations

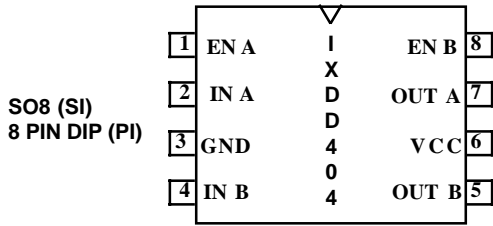

SO16 (SI-16)

1	EN A	NC	16
2	IN A	OUT A	15
3	NC	OUT A	14
4	GND	VCC	13
5	GND	VCC	12
6	NC	OUT B	11
7	IN B	OUT B	10
8	EN B	NC	9

Pin Description

SYMBOL	FUNCTION	DESCRIPTION
EN A	A Channel Enable	The Channel A enable pin. This pin, when driven low, disables the A Channel, forcing a high impedance state to the A Channel Output.
IN A	A Channel Input	A Channel Input signal-TTL or CMOS compatible.
GND	Ground	The system ground pin. Internally connected to all circuitry, this pin provides ground reference for the entire chip. This pin should be connected to a low noise analog ground plane for optimum performance.
IN B	B Channel Input	B Channel Input signal-TTL or CMOS compatible.
OUT B	B Channel Output	B Channel Driver output. For application purposes, this pin is connected, through a resistor, to Gate of a MOSFET/IGBT.
VCC	Supply Voltage	Positive power-supply voltage input. This pin provides power to the entire chip. The range for this voltage is from 4.5V to 25V.
OUT A	A Channel Output	A Channel Driver output. For application purposes, this pin is connected, through a resistor, to Gate of a MOSFET/IGBT.
EN B	B Channel Enable	The Channel B enable pin. This pin, when driven low, disables the B Channel, forcing a high impedance state to the B Channel Output.

Note 1: Operating the device beyond parameters with listed "absolute maximum ratings" may cause permanent damage to the device. Typical values indicate conditions for which the device is intended to be functional, but do not guarantee specific performance limits. The guaranteed specifications apply only for the test conditions listed. Exposure to absolute maximum rated conditions for extended periods may affect device reliability.

CAUTION: These devices are sensitive to electrostatic discharge; follow proper ESD procedures when handling and assembling this component.

Figure 2 - Characteristics Test Diagram

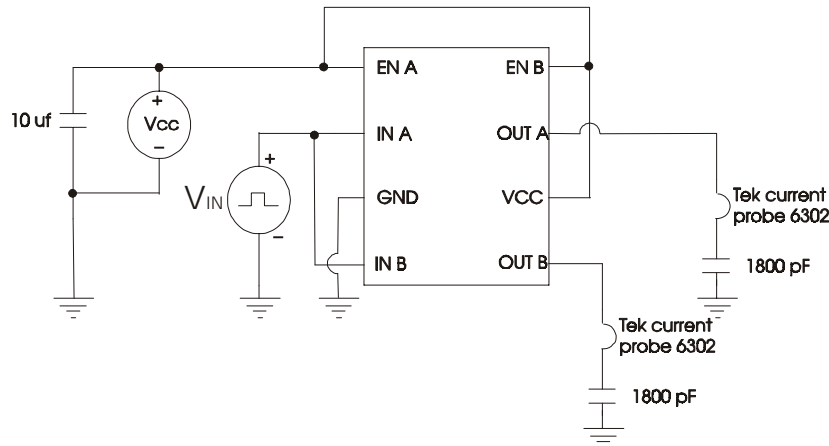

Typical Performance Characteristics

Fig. 3 Rise Time vs. Supply Voltage

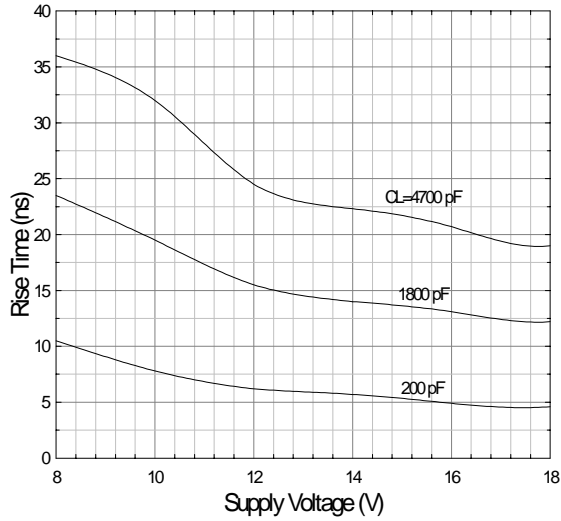

Fig. 4 Fall Time vs. Supply Voltage

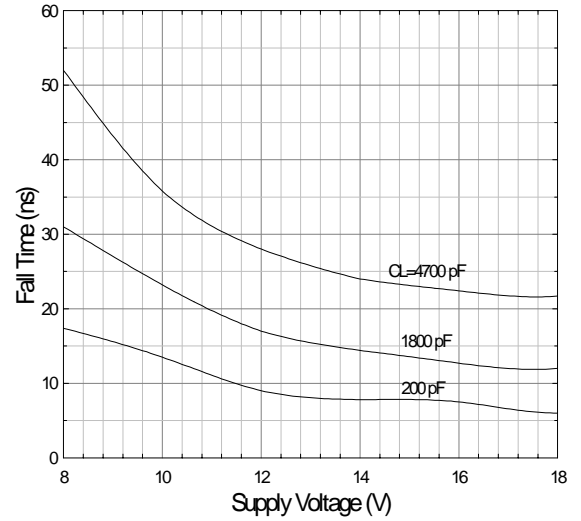

Fig. 5 Rise And Fall Times vs. Temperature
 $C_L = 18 \text{ V}$ $V_{CC} = 18 \text{ V}$

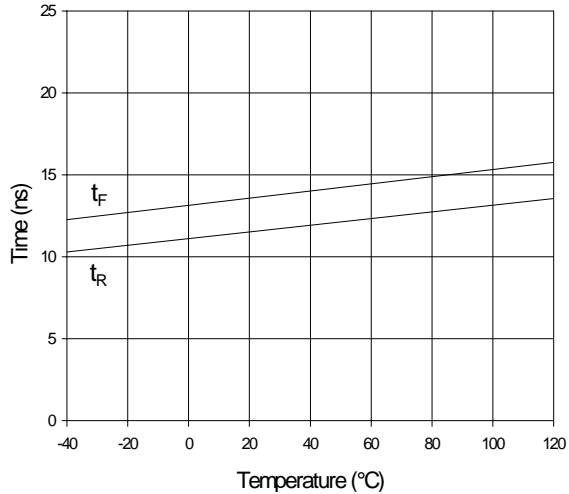

Fig. 6 Rise Time vs. Load Capacitance

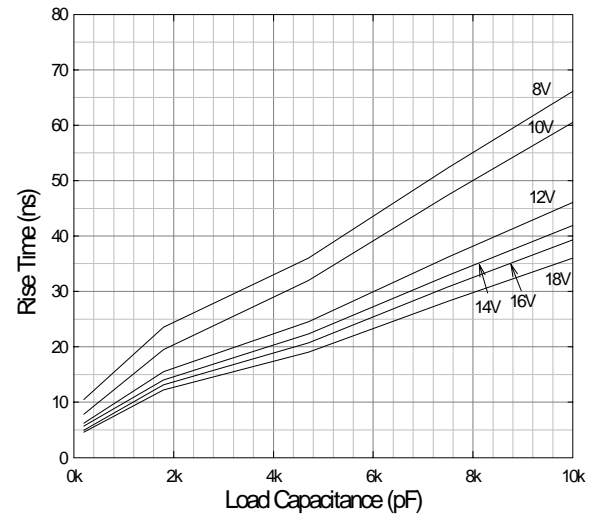

Fig. 7 Fall Time vs. Load Capacitance

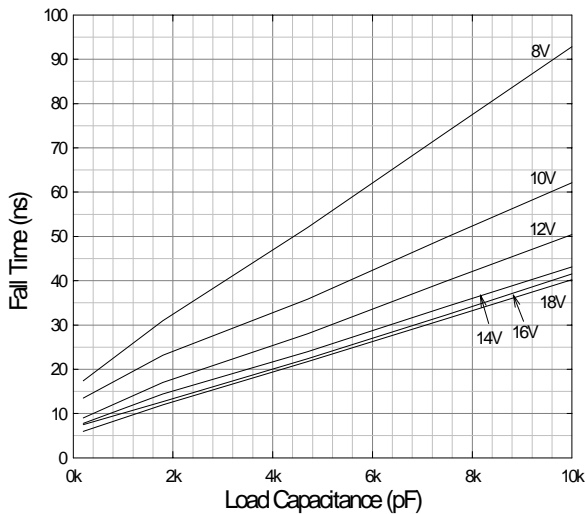
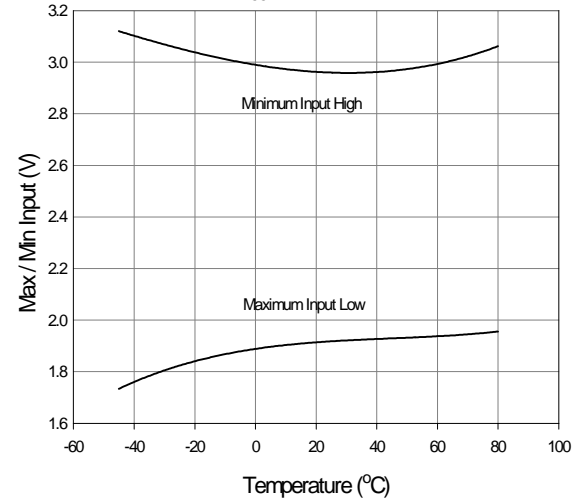
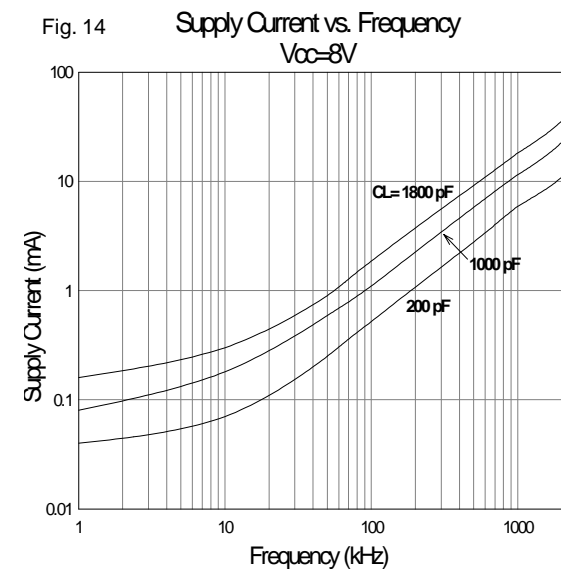
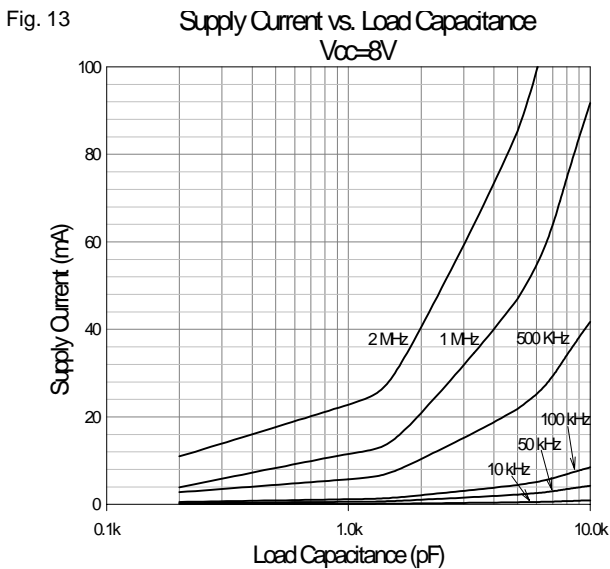
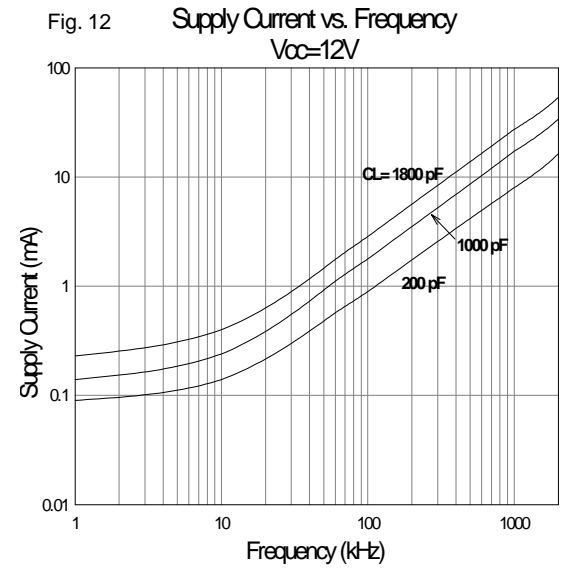
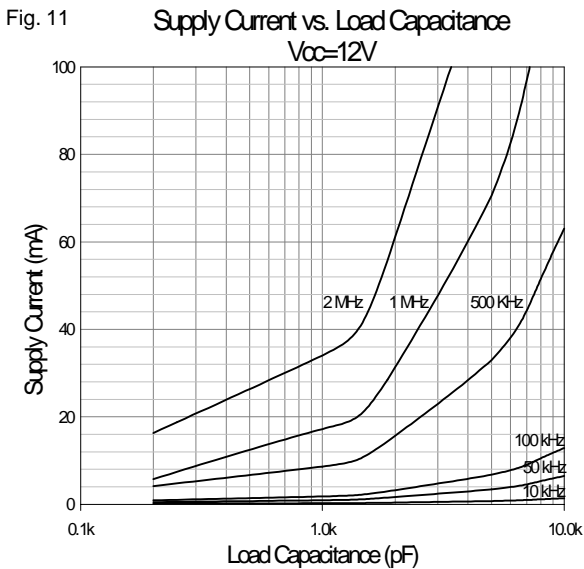
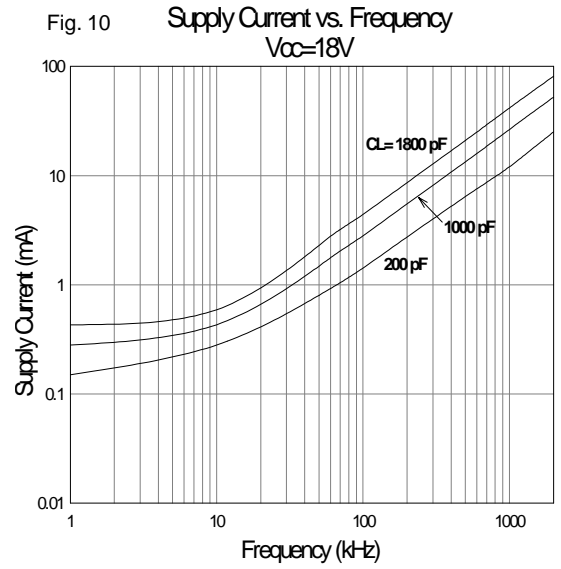
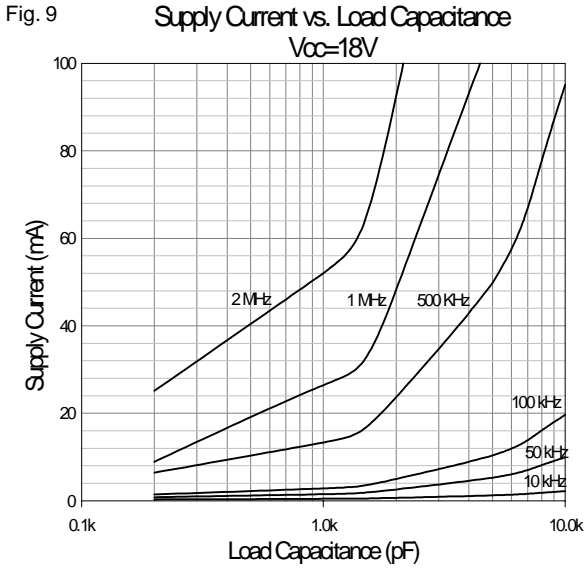
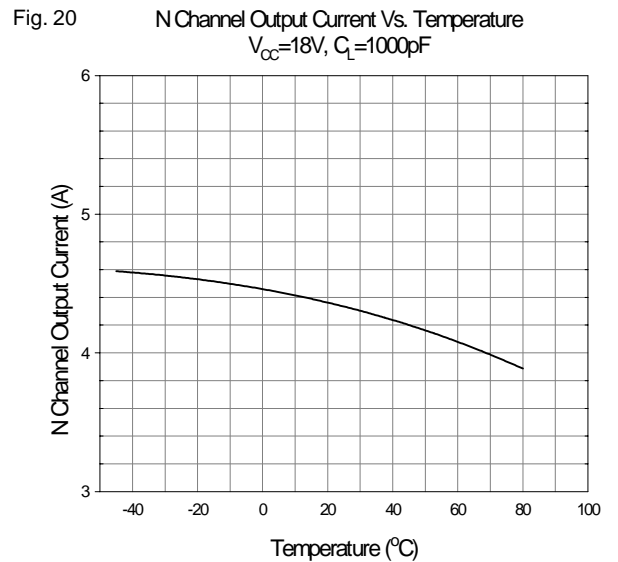
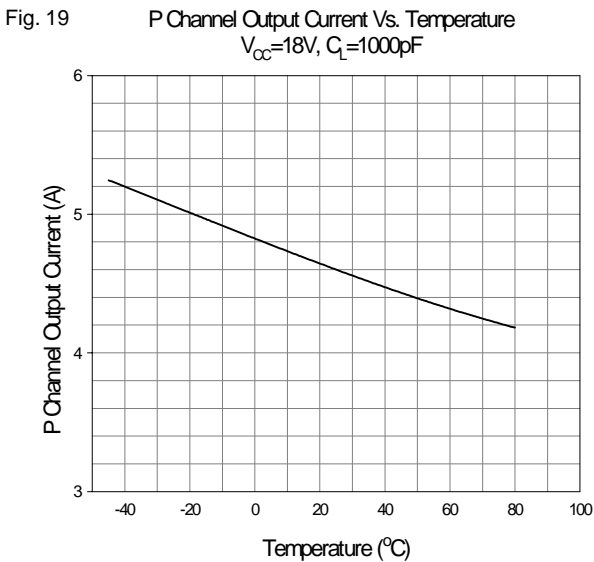
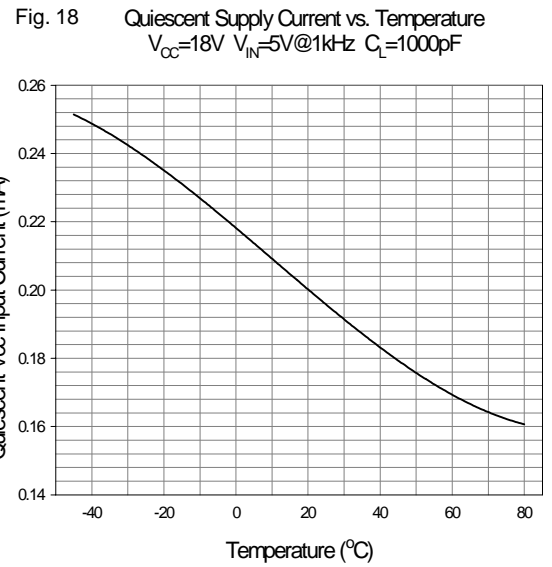
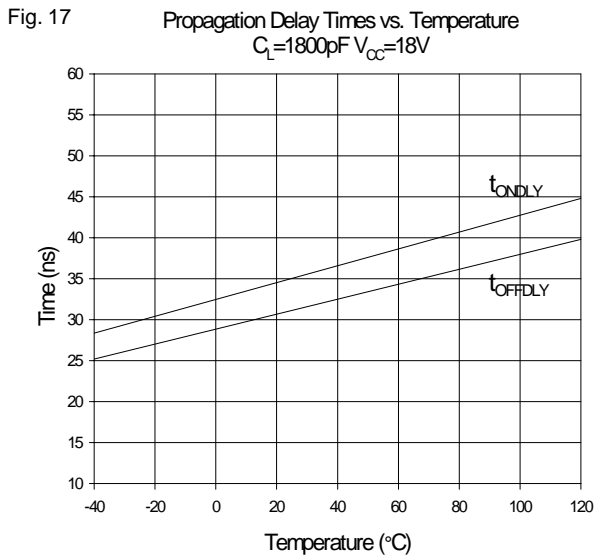
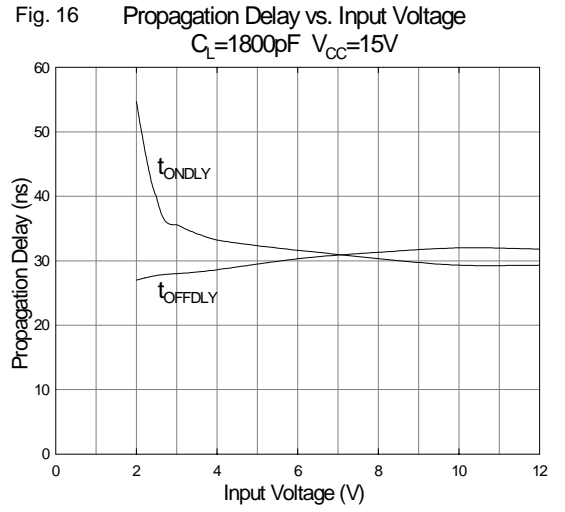
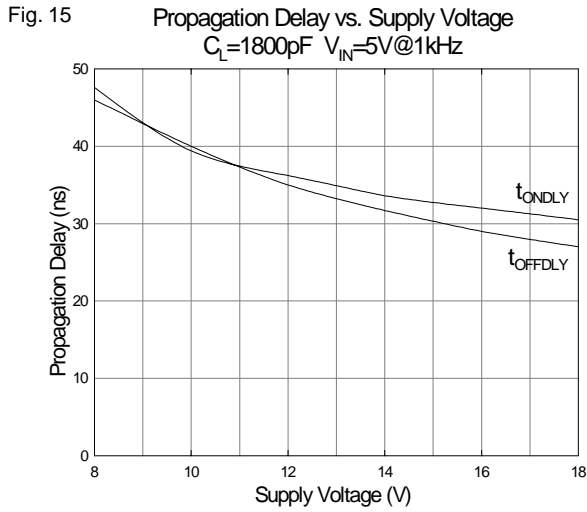

Fig. 8 Max / Min Input vs. Temperature
 $V_{CC} = 18 \text{ V}$ $C_L = 1 \text{ nF}$







Supply Bypassing and Grounding Practices, Output Lead inductance

When designing a circuit to drive a high speed MOSFET utilizing the IXDD404, it is very important to keep certain design criteria in mind, in order to optimize performance of the driver. Particular attention needs to be paid to **Supply Bypassing, Grounding,** and minimizing the **Output Lead Inductance.**

Say, for example, we are using the IXDD404 to charge a 2500pF capacitive load from 0 to 25 volts in 25ns.

Using the formula: $I = \Delta V C / \Delta t$, where $\Delta V=25V$ $C=2500pF$ & $\Delta t=25ns$ we can determine that to charge 2500pF to 25 volts in 25ns will take a constant current of 2.5A. (In reality, the charging current won't be constant, and will peak somewhere around 4A).

SUPPLY BYPASSING

In order for our design to turn the load on properly, the IXDD404 must be able to draw this 2.5A of current from the power supply in the 25ns. This means that there must be very low impedance between the driver and the power supply. The most common method of achieving this low impedance is to bypass the power supply at the driver with a capacitance value that is a magnitude larger than the load capacitance. Usually, this would be achieved by placing two different types of bypassing capacitors, with complementary impedance curves, very close to the driver itself. (These capacitors should be carefully selected, low inductance, low resistance, high-pulse current-service capacitors). Lead lengths may radiate at high frequency due to inductance, so care should be taken to keep the lengths of the leads between these bypass capacitors and the IXDD404 to an absolute minimum.

GROUNDING

In order for the design to turn the load off properly, the IXDD404 must be able to drain this 2.5A of current into an adequate grounding system. There are three paths for returning current that need to be considered: Path #1 is between the IXDD404 and it's load. Path #2 is between the IXDD404 and it's power supply. Path #3 is between the IXDD404 and whatever logic is driving it. All three of these paths should be as low in resistance and inductance as possible, and thus as short as practical. In addition, every effort should be made to keep these three ground paths distinctly separate. Otherwise, (for instance), the returning ground current from the load may develop a voltage that would have a detrimental effect on the logic line driving the IXDD404.

OUTPUT LEAD INDUCTANCE

Of equal importance to Supply Bypassing and Grounding are issues related to the Output Lead Inductance. Every effort should be made to keep the leads between the driver and it's load as short and wide as possible. If the driver must be placed farther than 2" from the load, then the output leads should be treated as transmission lines. In this case, a twisted-pair should be considered, and the return line of each twisted pair should be placed as close as possible to the ground pin of the driver, and connect directly to the ground terminal of the load.

TTL to High Voltage CMOS Level Translation

The enable (EN) input to the IXDD404 is a high voltage CMOS logic level input where the EN input threshold is $\frac{1}{2} V_{CC}$, and may not be compatible with 5V CMOS or TTL input levels. The IXDD404 EN input was intentionally designed for enhanced noise immunity with the high voltage CMOS logic levels. In a typical gate driver application, $V_{CC}=15V$ and the EN input threshold at 7.5V, a 5V CMOS logical high input applied to this typical IXDD404 application's EN input will be misinterpreted as a logical low, and may cause undesirable or unexpected results. The note below is for optional adaptation of TTL or 5V CMOS levels.

The circuit in Figure 28 alleviates this potential logic level misinterpretation by translating a TTL or 5V CMOS logic input to high voltage CMOS logic levels needed by the IXDD404 EN input. From the figure, V_{CC} is the gate driver power supply, typically set between 8V to 20V, and V_{DD} is the logic power supply, typically between 3.3V to 5.5V. Resistors R1 and R2 form a voltage divider network so that the Q1 base is positioned at the midpoint of the expected TTL logic transition levels.

A TTL or 5V CMOS logic low, $V_{TTLLOW} \approx 0.8V$, input applied to the Q1 emitter will drive it on. This causes the level translator output, the Q1 collector output to settle to $V_{CESATQ1} + V_{TTLLOW} \approx 2V$, which is sufficiently low to be correctly interpreted as a high voltage CMOS logic low ($< 1/3 V_{CC} = 5V$ for $V_{CC}=15V$ given in the IXDD404 data sheet.)

A TTL high, $V_{TTLHIGH} \approx 2.4V$, or a 5V CMOS high, $V_{5VCMOSHIGH} \approx 3.5V$, applied to the EN input of the circuit in Figure 28 will cause Q1 to be biased off. This results in Q1 collector being pulled up by R3 to $V_{CC}=15V$, and provides a high voltage CMOS logic high output. The high voltage CMOS logical EN output applied to the IXDD404 EN input will enable it, allowing the gate driver to fully function as a ± 4 Amp output driver.

The total component cost of the circuit in Figure 28 is less than \$0.10 if purchased in quantities >1K pieces. It is recommended that the physical placement of the level translator circuit be placed close to the source of the TTL or CMOS logic circuits to maximize noise rejection.

Figure 28 - TTL to High Voltage CMOS Level Translator

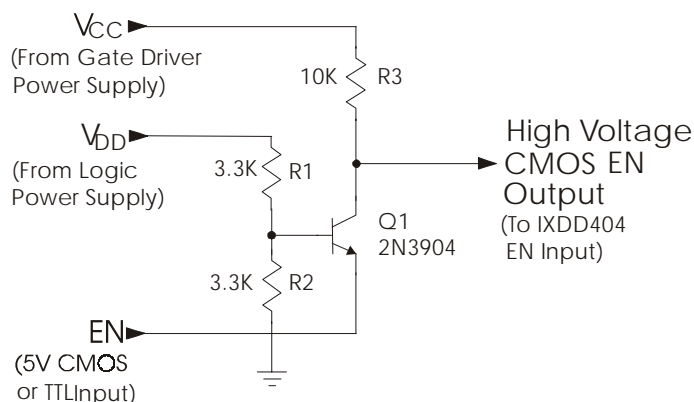

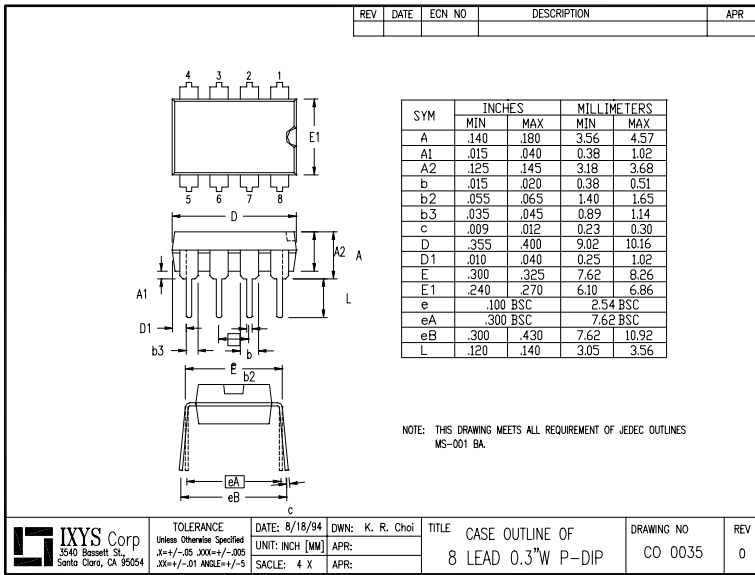

Ordering Information		
Part Number	Package Type	Temp. Range
IXDD404PI	8-Pin PDIP	-40°C to +85°C
IXDD404SI	8-Pin SOIC	-40°C to +85°C
IXDD404SI-16	16-Pin SOIC	-40°C to +85°C

NOTE: Mounting or solder tabs on all packages are connected to ground

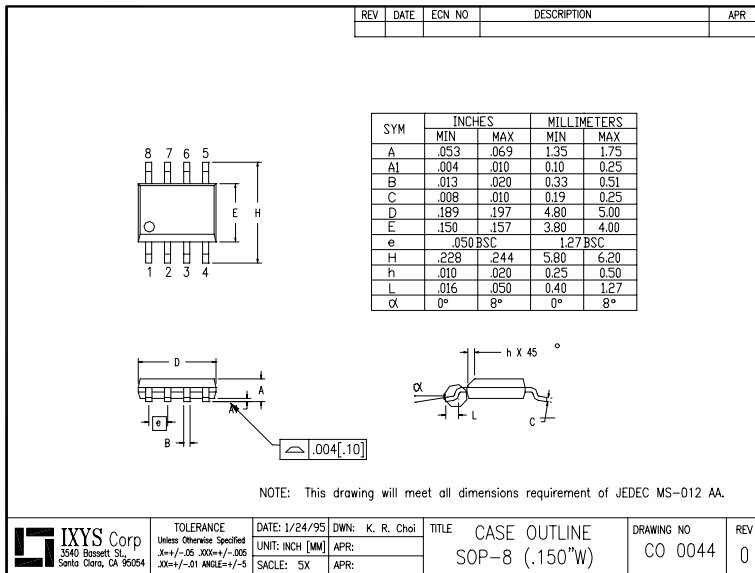

IXYS Corporation
3540 Bassett St; Santa Clara, CA 95054
Tel: 408-982-0700; Fax: 408-496-0670
e-mail: sales@ixys.net

IXYS Semiconductor GmbH
Edisonstrasse 15 ; D-68623; Lampertheim
Tel: +49-6206-503-0; Fax: +49-6206-503627
e-mail: marcom@ixys.de

Directed Energy, Inc.
An IXYS Company
2401 Research Blvd. Ste. 108, Ft. Collins, CO 80526
Tel: 970-493-1901; Fax: 970-493-1903
e-mail: deiinfo@directedenergy.com

