

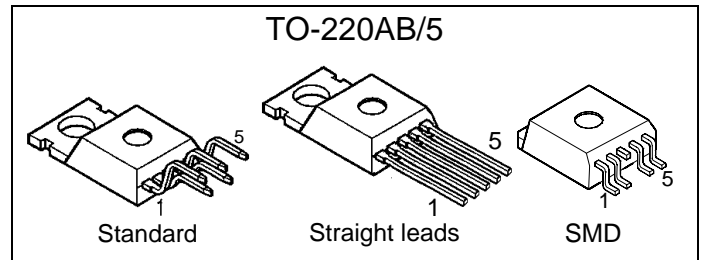
## Smart Highside Power Switch

### Features

- Overload protection
- Current limitation
- Short-circuit protection
- Thermal shutdown
- Overvoltage protection (including load dump)
- Fast demagnetization of inductive loads
- Reverse battery protection<sup>1)</sup>
- Undervoltage and overvoltage shutdown with auto-restart and hysteresis
- CMOS diagnostic output
- Open load detection in ON-state
- CMOS compatible input
- Loss of ground and loss of  $V_{bb}$  protection<sup>2)</sup>
- Electrostatic discharge (ESD) protection

### Product Summary

Overvoltage protection	$V_{bb(AZ)}$	63	V
Operating voltage	$V_{bb(on)}$	4.5 ... 42	V
On-state resistance	$R_{ON}$	18	mΩ
Load current (ISO)	$I_L(ISO)$	21	A
Current limitation	$I_L(SCr)$	70	A

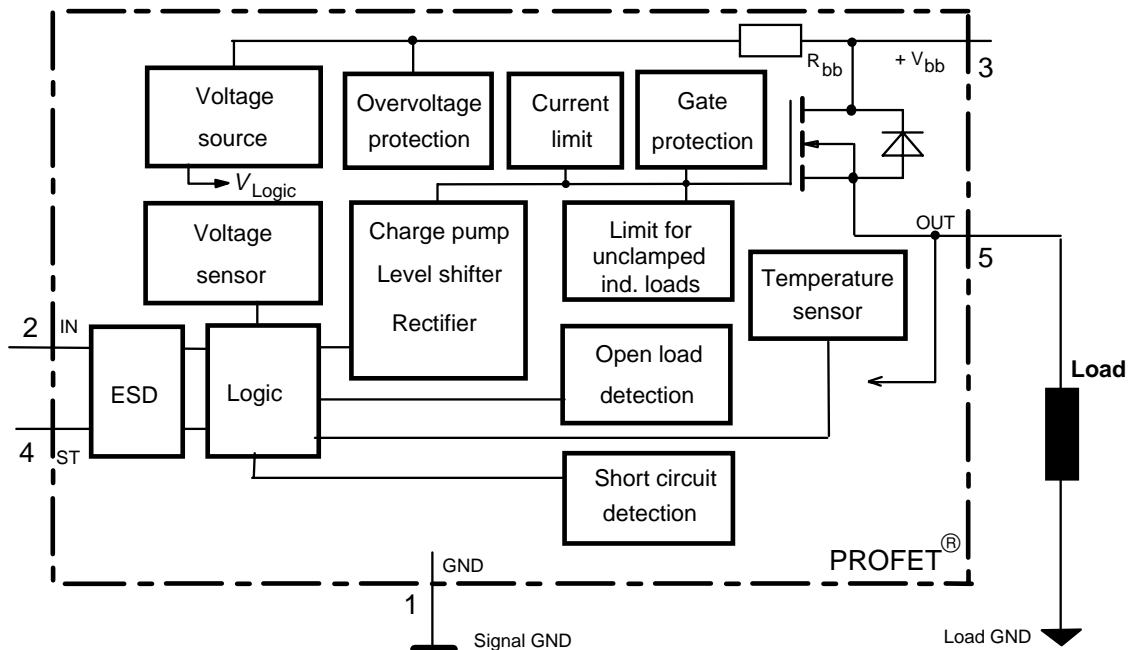


### Application

- $\mu$ C compatible power switch with diagnostic feedback for 12 V and 24 V DC grounded loads
- All types of resistive, inductive and capacitive loads
- Replaces electromechanical relays and discrete circuits

### General Description

N channel vertical power FET with charge pump, ground referenced CMOS compatible input and diagnostic feedback, integrated in Smart SIPMOS® chip on chip technology. Fully protected by embedded protection functions.



1) No external components required, reverse load current limited by connected load.

2) Additional external diode required for charged inductive loads

Pin	Symbol		Function
1	GND	-	Logic ground
2	IN	I	Input, activates the power switch in case of logical high signal
3	Vbb	+	Positive power supply voltage, the tab is shorted to this pin
4	ST	S	Diagnostic feedback, low on failure
5	OUT (Load, L)	O	Output to the load

### Maximum Ratings at $T_j = 25\text{ °C}$ unless otherwise specified

Parameter	Symbol	Values	Unit	
Supply voltage (overvoltage protection see page 3)	$V_{bb}$	63	V	
Load dump protection $V_{LoadDump} = U_A + V_s$ , $U_A = 13.5\text{ V}$ $R_I = 2\ \Omega$ , $R_L = 1.1\ \Omega$ , $t_d = 200\text{ ms}$ , IN= low or high	$V_{Load\ dump}^{3)}$	80	V	
Load current (Short-circuit current, see page 4)	$I_L$	self-limited	A	
Operating temperature range	$T_j$	-40 ... +150	°C	
Storage temperature range	$T_{stg}$	-55 ... +150		
Power dissipation (DC)	$P_{tot}$	167	W	
Inductive load switch-off energy dissipation, single pulse $T_j = 150\text{ °C}$ :	$E_{AS}$	2.1	J	
Electrostatic discharge capability (ESD) (Human Body Model)	$V_{ESD}$	2.0	kV	
Input voltage (DC)	$V_{IN}$	-0.5 ... +6	V	
Current through input pin (DC)	$I_{IN}$	$\pm 5.0$	mA	
Current through status pin (DC)	$I_{ST}$	$\pm 5.0$		
see internal circuit diagrams page 6...				
Thermal resistance	chip - case: junction - ambient (free air): SMD version, device on pcb <sup>4)</sup> :	$R_{thJC}$ $R_{thJA}$	$\leq 0.75$ $\leq 75$ $\leq tbd$	K/W

3)  $V_{Load\ dump}$  is setup without the DUT connected to the generator per ISO 7637-1 and DIN 40839

4) Device on 50mm\*50mm\*1.5mm epoxy PCB FR4 with 6cm<sup>2</sup> (one layer, 70µm thick) copper area for  $V_{bb}$  connection. PCB is vertical without blown air.

## Electrical Characteristics

Parameter and Conditions at $T_j = 25\text{ °C}$ , $V_{bb} = 12\text{ V}$ unless otherwise specified	Symbol	Values			Unit
		min	typ	max	

### Load Switching Capabilities and Characteristics

On-state resistance (pin 3 to 5) $I_L = 5\text{ A}$	$T_j=25\text{ °C}$ : $T_j=150\text{ °C}$ :	$R_{ON}$	--	15 28	18 35	mΩ
Nominal load current (pin 3 to 5) ISO Proposal: $V_{ON} = 0.5\text{ V}$ , $T_C = 85\text{ °C}$		$I_{L(ISO)}$	17	21	--	A
Output current (pin 5) while GND disconnected or GND pulled up, $V_{IN} = 0$ , see diagram page 7, $T_j = -40\dots+150\text{ °C}$		$I_{L(GNDhigh)}$	--	--	1	mA
Turn-on time to 90% $V_{OUT}$ :		$t_{on}$	100	--	350	μs
Turn-off time to 10% $V_{OUT}$ :		$t_{off}$	10	--	130	
$R_L = 12\text{ Ω}$ , $T_j = -40\dots+150\text{ °C}$						
Slew rate on 10 to 30% $V_{OUT}$ , $R_L = 12\text{ Ω}$ , $T_j = -40\dots+150\text{ °C}$		$dV/dt_{on}$	0.2	--	2	V/μs
Slew rate off 70 to 40% $V_{OUT}$ , $R_L = 12\text{ Ω}$ , $T_j = -40\dots+150\text{ °C}$		$-dV/dt_{off}$	0.4	--	5	V/μs

### Operating Parameters

Operating voltage <sup>5)</sup>	$T_j = -40\dots+150\text{ °C}$ :	$V_{bb(on)}$	4.5	--	42	V
Undervoltage shutdown	$T_j = -40\dots+150\text{ °C}$ :	$V_{bb(under)}$	2.4	--	4.5	V
Undervoltage restart	$T_j = -40\dots+150\text{ °C}$ :	$V_{bb(u\text{ rst})}$	--	--	4.5	V
Undervoltage restart of charge pump see diagram page 12	$T_j = -40\dots+150\text{ °C}$ :	$V_{bb(ucp)}$	--	6.5	7.5	V
Undervoltage hysteresis $\Delta V_{bb(under)} = V_{bb(u\text{ rst})} - V_{bb(under)}$		$\Delta V_{bb(under)}$	--	0.2	--	V
Overvoltage shutdown	$T_j = -40\dots+150\text{ °C}$ :	$V_{bb(over)}$	42	--	52	V
Overvoltage restart	$T_j = -40\dots+150\text{ °C}$ :	$V_{bb(o\text{ rst})}$	42	--	--	V
Overvoltage hysteresis	$T_j = -40\dots+150\text{ °C}$ :	$\Delta V_{bb(over)}$	--	0.2	--	V
Overvoltage protection <sup>6)</sup>	$T_j = -40\text{ °C}$ :	$V_{bb(AZ)}$	60	--	--	V
$I_{bb}=40\text{ mA}$	$T_j = 25\dots+150\text{ °C}$ :		63	67		
Standby current (pin 3) $V_{IN}=0$ , $I_{ST}=0$ ,	$T_j = -40\dots+25\text{ °C}$ :	$I_{bb(off)}$	--	12	25	μA
	$T_j = 150\text{ °C}$ :		--	18	60	
Leakage output current (included in $I_{bb(off)}$ ) $V_{IN}=0$		$I_{L(off)}$	--	6	--	μA
Operating current (Pin 1) <sup>7)</sup> , $V_{IN}=5\text{ V}$		$I_{GND}$	--	1.1	--	mA

5) At supply voltage increase up to  $V_{bb} = 6.5\text{ V}$  typ without charge pump,  $V_{OUT} \approx V_{bb} - 2\text{ V}$

6) see also  $V_{ON(CL)}$  in table of protection functions and circuit diagram page 7. Measured without load.

7) Add  $I_{ST}$ , if  $I_{ST} > 0$ , add  $I_{IN}$ , if  $V_{IN} > 5.5\text{ V}$

Parameter and Conditions at $T_j = 25\text{ °C}$ , $V_{bb} = 12\text{ V}$ unless otherwise specified	Symbol	Values			Unit
		min	typ	max	
<b>Protection Functions</b>					
Initial peak short circuit current limit (pin 3 to 5) <sup>8)</sup> , (max 400 $\mu\text{s}$ if $V_{ON} > V_{ON(SC)}$ )	$I_{L(SCp)}$				
$T_j = -40\text{ °C}$ :		--	--	140	A
$T_j = 25\text{ °C}$ :		--	95	--	
$T_j = +150\text{ °C}$ :		45	--	--	
Repetitive short circuit current limit $T_j = T_{jt}$ (see timing diagrams, page 10)	$I_{L(SCr)}$	30	70	--	A
Short circuit shutdown delay after input pos. slope $V_{ON} > V_{ON(SC)}$ , $T_j = -40..+150\text{ °C}$ : min value valid only, if input "low" time exceeds 30 $\mu\text{s}$	$t_{d(SC)}$	80	--	400	$\mu\text{s}$
Output clamp (inductive load switch off) at $V_{OUT} = V_{bb} - V_{ON(CL)}$ , $I_L = 30\text{ mA}$	$V_{ON(CL)}$	--	58	--	V
Short circuit shutdown detection voltage (pin 3 to 5)	$V_{ON(SC)}$	--	8.3	--	V
Thermal overload trip temperature	$T_{jt}$	150	--	--	$\text{°C}$
Thermal hysteresis	$\Delta T_{jt}$	--	10	--	K
Inductive load switch-off energy dissipation <sup>9)</sup> , $T_{j\text{ Start}} = 150\text{ °C}$ , single pulse	$E_{AS}$	--	--	2.1	J
$V_{bb} = 12\text{ V}$ :	$E_{Load12}$			1.7	
$V_{bb} = 24\text{ V}$ :	$E_{Load24}$			1.2	
Reverse battery (pin 3 to 1) <sup>10)</sup>	$-V_{bb}$	--	--	32	V
Integrated resistor in $V_{bb}$ line	$R_{bb}$	--	120	--	$\Omega$

### Diagnostic Characteristics



Open load detection current (on-condition)	$T_j = -40\text{ °C}$ : $T_j = 25..150\text{ °C}$ :	$I_{L(OL)}$	2 2	-- --	1900 1500	mA
---	--	-------------	--------	----------	--------------	----

<sup>8)</sup> Short circuit current limit for max. duration of  $t_{d(SC)}$  max=400  $\mu\text{s}$ , prior to shutdown

<sup>9)</sup> While demagnetizing load inductance, dissipated energy in PROFET is  $E_{AS} = \int V_{ON(CL)} * I_L(t) dt$ , approx.

$$E_{AS} = \frac{1}{2} * L * I_L^2 * \left( \frac{V_{ON(CL)}}{V_{ON(CL)} - V_{bb}} \right), \text{ see diagram page 8}$$

<sup>10)</sup> Reverse load current (through intrinsic drain-source diode) is normally limited by the connected load. Reverse current  $I_{GND}$  of  $\approx 0.3\text{ A}$  at  $V_{bb} = -32\text{ V}$  through the logic heats up the device. Time allowed under these condition is dependent on the size of the heatsink. Reverse  $I_{GND}$  can be reduced by an additional external GND-resistor (150  $\Omega$ ). Input and Status currents have to be limited (see max. ratings page 2 and circuit page 7).

Parameter and Conditions at $T_j = 25\text{ °C}$ , $V_{bb} = 12\text{ V}$ unless otherwise specified	Symbol	Values			Unit
		min	typ	max	
<b>Input and Status Feedback<sup>11)</sup></b>					
Input turn-on threshold voltage  $T_j = -40..+150\text{ °C}$ :	$V_{IN(T+)}$	1.5	--	2.4	V
Input turn-off threshold voltage  $T_j = -40..+150\text{ °C}$ :	$V_{IN(T-)}$	1.0	--	--	V
Input threshold hysteresis	$\Delta V_{IN(T)}$	--	0.5	--	V
Off state input current (pin 2), $V_{IN} = 0.4\text{ V}$	$I_{IN(off)}$	1	--	30	$\mu\text{A}$
On state input current (pin 2), $V_{IN} = 3.5\text{ V}$	$I_{IN(on)}$	10	25	50	$\mu\text{A}$
Status invalid after positive input slope (short circuit) $T_j = -40 \dots +150\text{ °C}$ :	$t_{d(ST\ SC)}$	80	200	400	$\mu\text{s}$
Status invalid after positive input slope (open load) $T_j = -40 \dots +150\text{ °C}$ :	$t_{d(ST)}$	350	--	1600	$\mu\text{s}$
Status output (CMOS) $T_j = -40\dots+150\text{ °C}$ , $I_{ST} = -50\text{ }\mu\text{A}$ :	$V_{ST(high)}^{12)}$	4.4	5.1	6.5	V
$T_j = -40\dots+150\text{ °C}$ , $I_{ST} = +1.6\text{ mA}$ :	$V_{ST(low)}$	--	--	0.4	
Max. status current for valid status output, $T_j = -40\dots+150\text{ °C}$	current source (out): $-I_{ST}$	--	--	0.25	mA
	current sink (in) : $+I_{ST}^{13)}$	--	--	1.6	

11) If a ground resistor  $R_{GND}$  is used, add the voltage drop across this resistor.

12)  $V_{St\ high} \approx V_{bb}$  during undervoltage shutdown

13) No current sink capability during undervoltage shutdown

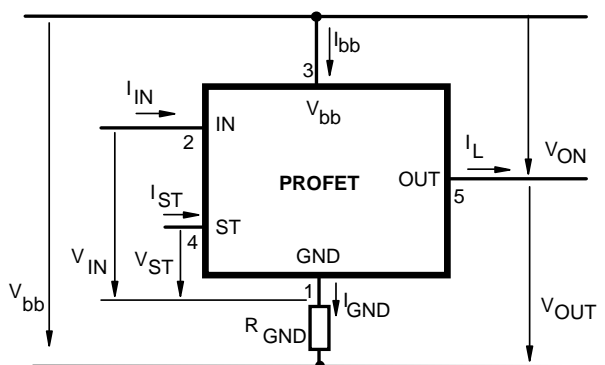
## Truth Table

	Input-level	Output level	Status	
			442 D2	442 E2
Normal operation	L	L	H	H
	H	H	H	H
Open load	L	<sup>14)</sup> H	H	H
	H	H	L	L
Short circuit to GND	L	L	H	H
	H	L	L	L
Short circuit to V <sub>bb</sub>	L	H	H	H
	H	H	H (L <sup>15)</sup> )	H (L <sup>15)</sup> )
Overtemperature	L	L	L	L
	H	L	L	L
Under-voltage	L	L	L <sup>16)</sup>	H
	H	L	L <sup>16)</sup>	H
Overvoltage	L	L	L	H
	H	L	L	H

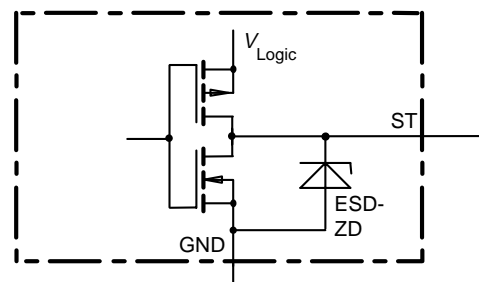
L = "Low" Level

H = "High" Level

## Terms

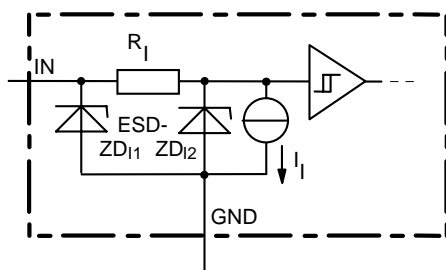


## Status output



Zener diode: 6.1 V typ., max 5 mA, V<sub>Logic</sub> 5 V typ, ESD zener diodes are not to be used as voltage clamp at DC conditions. Operation in this mode may result in a drift of the zener voltage (increase of up to 1 V).

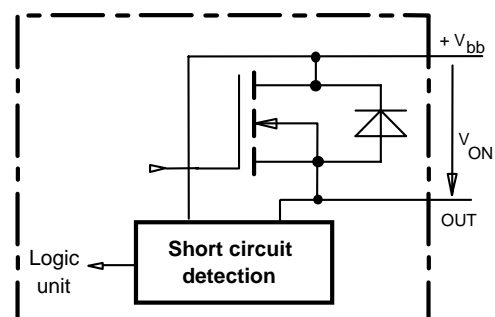
## Input circuit (ESD protection)



ZD<sub>11</sub> 6.1 V typ., ESD zener diodes are not to be used as voltage clamp at DC conditions. Operation in this mode may result in a drift of the zener voltage (increase of up to 1 V).

## Short Circuit detection

Fault Condition: V<sub>ON</sub> > 8.3 V typ.; IN high

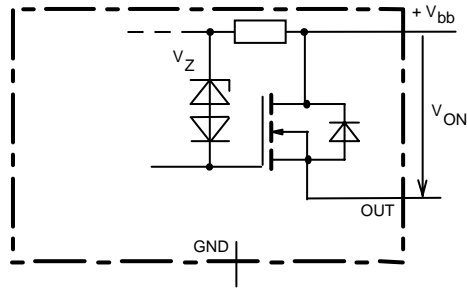


14) Power Transistor off, high impedance

15) Low resistance short V<sub>bb</sub> to output may be detected by no-load-detection

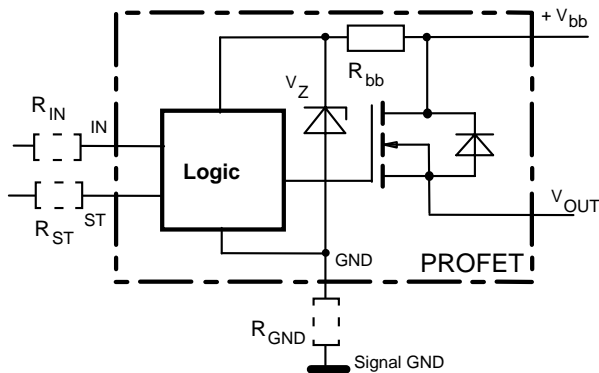
16) No current sink capability during undervoltage shutdown

## Inductive and overvoltage output clamp



$V_{ON}$  clamped to 58 V typ.

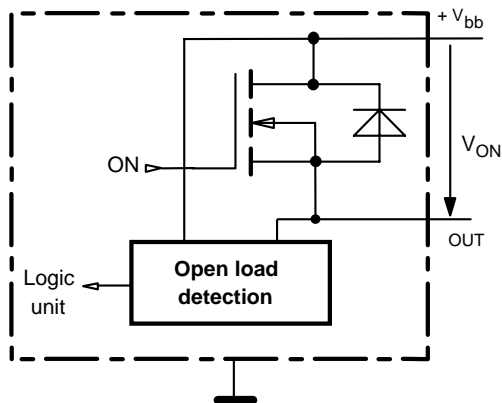
## Overvolt. and reverse batt. protection



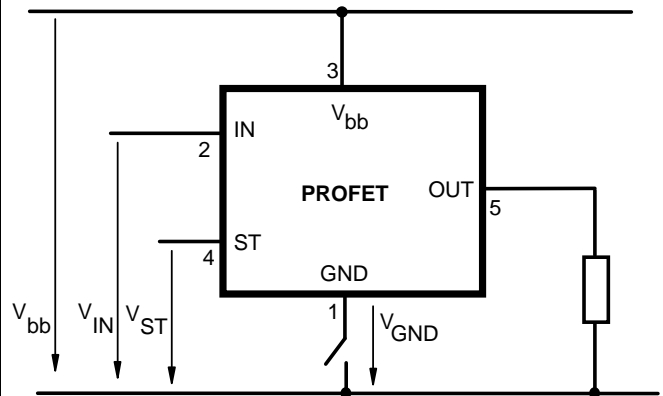
$R_{bb} = 120 \Omega$  typ.,  $V_Z + R_{bb} \cdot 40 \text{ mA} = 67 \text{ V}$  typ., add  $R_{GND}$ ,  $R_{IN}$ ,  $R_{ST}$  for extended protection

## Open-load detection

ON-state diagnostic condition:  $V_{ON} < R_{ON} \cdot I_{L(OL)}$ ; IN high

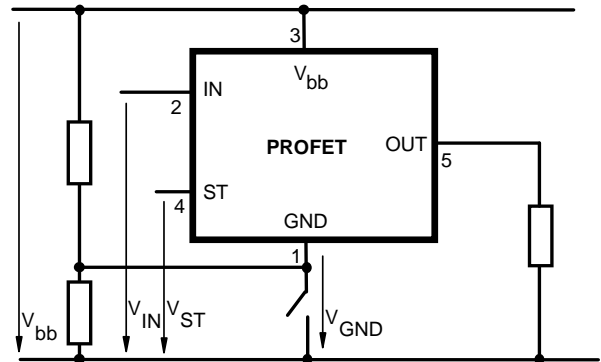


## GND disconnect



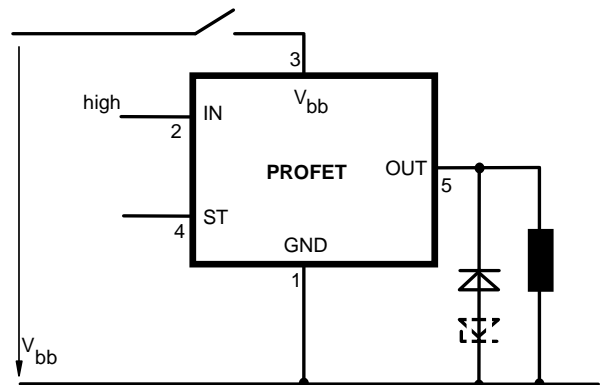
Any kind of load. In case of Input=high is  $V_{OUT} \approx V_{IN} - V_{IN(T+)}$ . Due to  $V_{GND} > 0$ , no  $V_{ST} = \text{low}$  signal available.

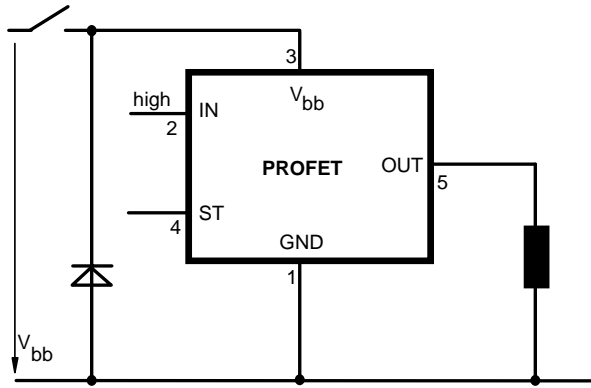
## GND disconnect with GND pull up



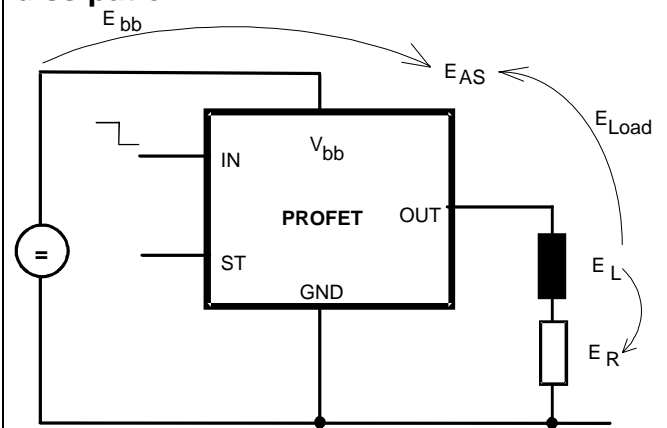
Any kind of load. If  $V_{GND} > V_{IN} - V_{IN(T+)}$  device stays off. Due to  $V_{GND} > 0$ , no  $V_{ST} = \text{low}$  signal available.

## Vbb disconnect with charged inductive load





### Inductive Load switch-off energy dissipation



Energy dissipated in PROFET  $E_{AS} = E_{bb} + E_L - E_R$ .

$$E_{Load} < E_L, E_L = \frac{1}{2} * L * I_L^2$$



## Options Overview

**all versions: High-side switch, Input protection, ESD protection, load dump and reverse battery protection , protection against loss of ground**

Type	BTS	442D2	442E2
Logic version		<b>D</b>	<b>E</b>
Overtemperature protection $T_j > 150\text{ °C}$ , latch function <sup>17)18)</sup> $T_j > 150\text{ °C}$ , with auto-restart on cooling		<b>X</b>	<b>X</b>
Short-circuit to GND protection switches off when $V_{ON} > 8.3\text{ V typ.}^{17)}$ (when first turned on after approx. 200 $\mu\text{s}$ )		<b>X</b>	<b>X</b>
Open load detection in OFF-state with sensing current 30 $\mu\text{A typ.}$ in ON-state with sensing voltage drop across power transistor		<b>X</b>	<b>X</b>
Undervoltage shutdown with auto restart		<b>X</b>	<b>X</b>
Overvoltage shutdown with auto restart		<b>X</b>	<b>X</b>
Status feedback for			
overtemperature		<b>X</b>	<b>X</b>
short circuit to GND		<b>X</b>	<b>X</b>
short to $V_{bb}$		<b>-19)</b>	<b>-19)</b>
open load		<b>X</b>	<b>X</b>
undervoltage		<b>X</b>	-
overvoltage		<b>X</b>	-
Status output type			
CMOS		<b>X</b>	
Open drain			<b>X</b>
Output negative voltage transient limit (fast inductive load switch off)			
to $V_{bb} - V_{ON(CL)}$		<b>X</b>	<b>X</b>
Load current limit			
high level (can handle loads with high inrush currents)		<b>X</b>	<b>X</b>
medium level			
low level (better protection of application)			

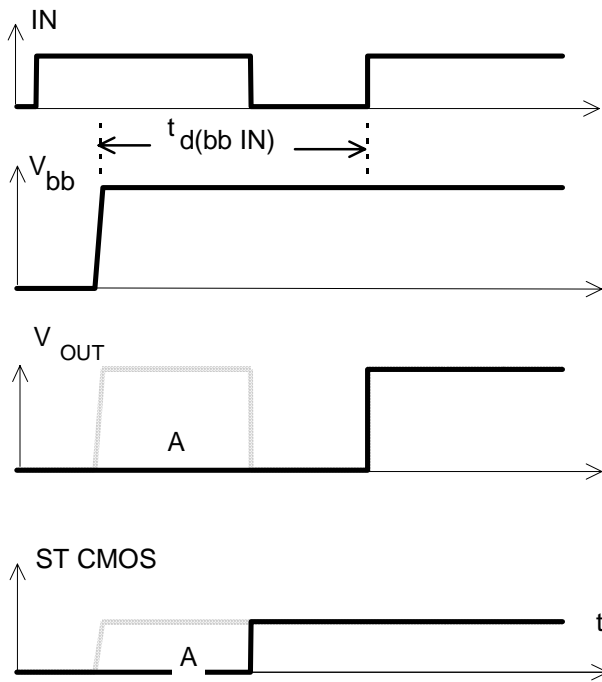
<sup>17)</sup> Latch except when  $V_{bb} - V_{OUT} < V_{ON(SC)}$  after shutdown. In most cases  $V_{OUT} = 0\text{ V}$  after shutdown ( $V_{OUT} \neq 0\text{ V}$  only if forced externally). So the device remains latched unless  $V_{bb} < V_{ON(SC)}$  (see page 4). No latch between turn on and  $t_{d(SC)}$ .

<sup>18)</sup> With latch function. Reseted by a) Input low, b) Undervoltage, c) Overvoltage

<sup>19)</sup> Low resistance short  $V_{bb}$  to output may be detected by no-load-detection

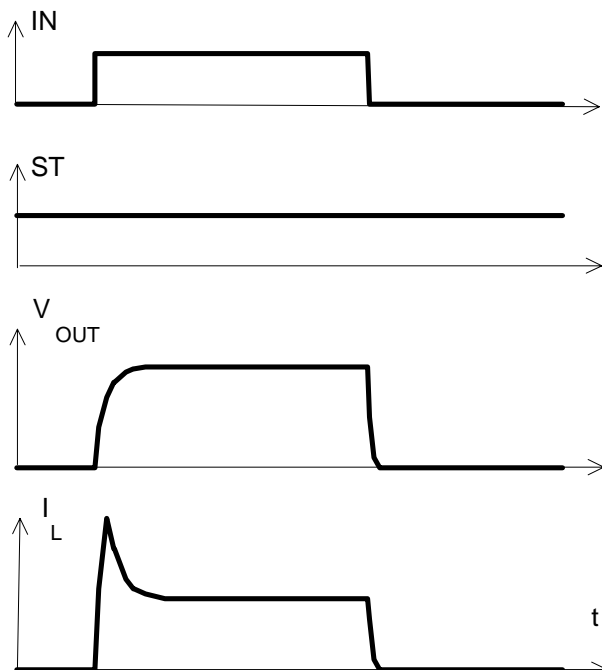
## Timing diagrams

**Figure 1a:**  $V_{bb}$  turn on:

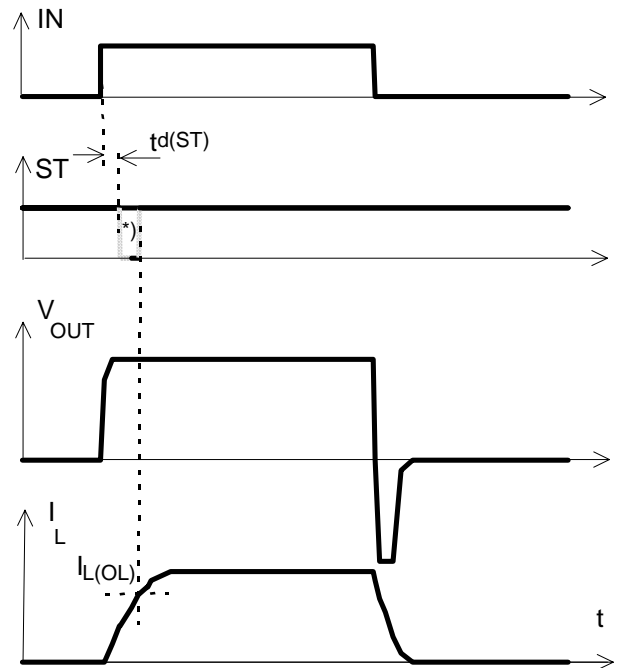


in case of too early  $V_{IN}$ =high the device may not turn on (curve A)  
 $t_{d(bb\ IN)}$  approx. 150  $\mu$ s

**Figure 2a:** Switching a lamp,

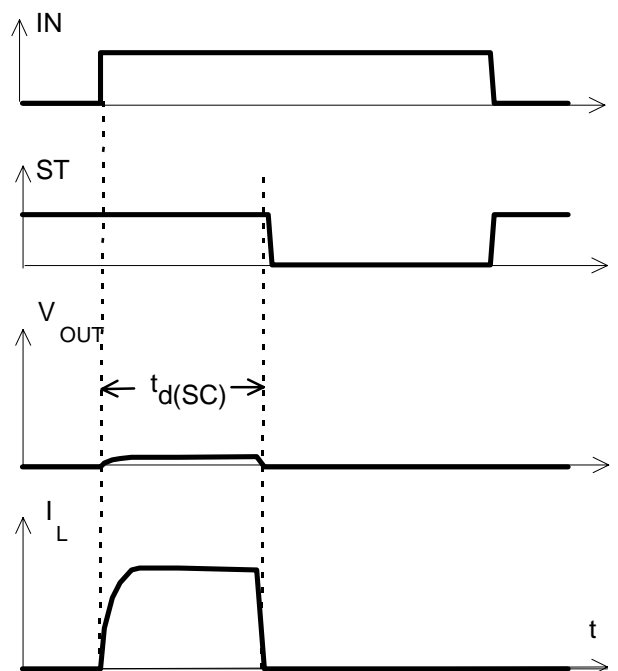


**Figure 2b:** Switching an inductive load



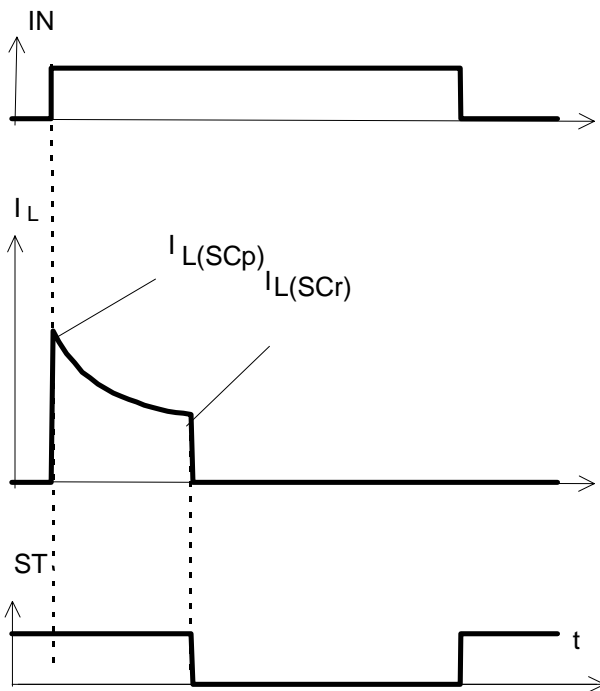
\*) if the time constant of load is too large, open-load-status may occur

**Figure 3a:** Turn on into short circuit,



$t_{d(SC)}$  approx. 200  $\mu$ s if  $V_{bb} - V_{OUT} > 8.3$  V typ.

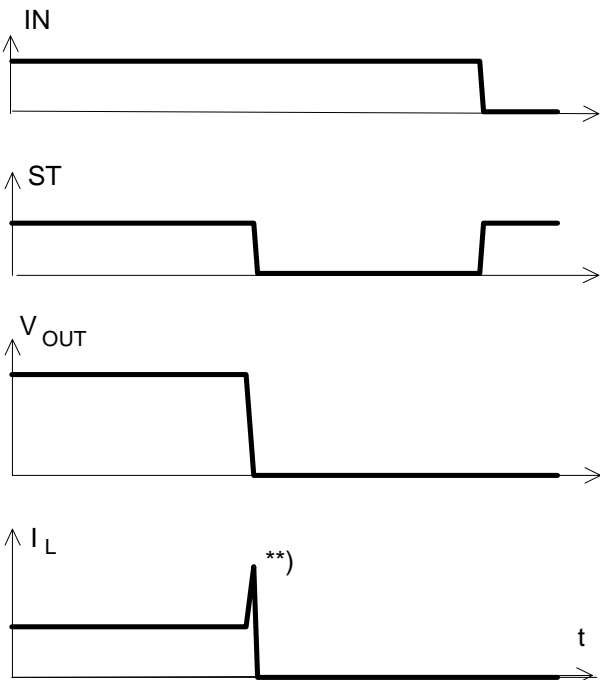
**Figure 3b:** Turn on into overload,



Heating up may require several milliseconds,  
 $V_{bb} - V_{OUT} < 8.3 \text{ V typ.}$

$V_{bb} - V_{OUT} < 8.3 \text{ V typ.}$

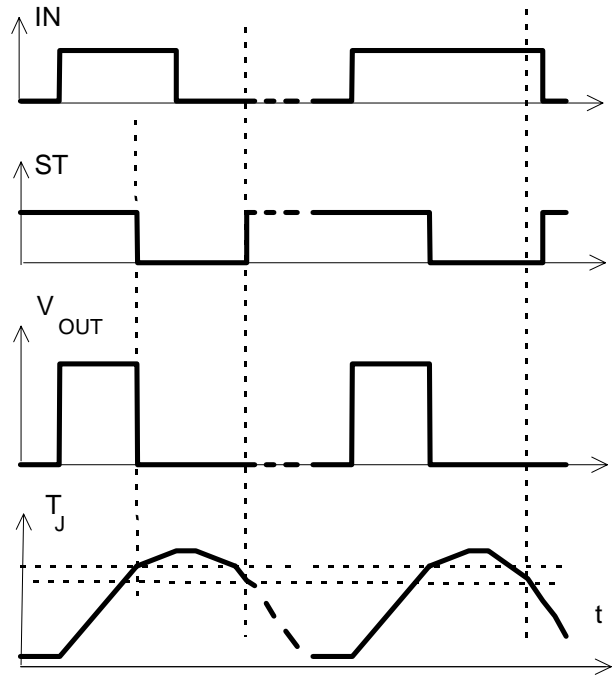
**Figure 3c:** Short circuit while on:



\*\*) current peak approx. 20  $\mu\text{s}$

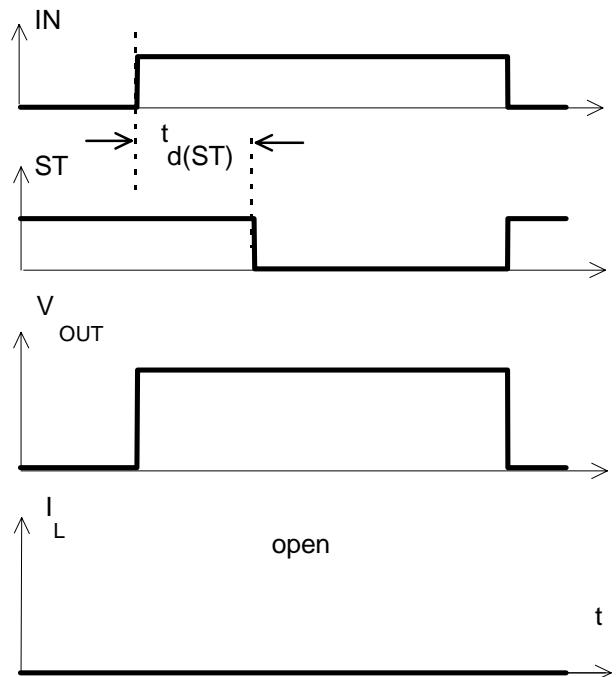
**Figure 4a:** Overtemperature,

Reset if (IN=low) and ( $T_j < T_{jt}$ )

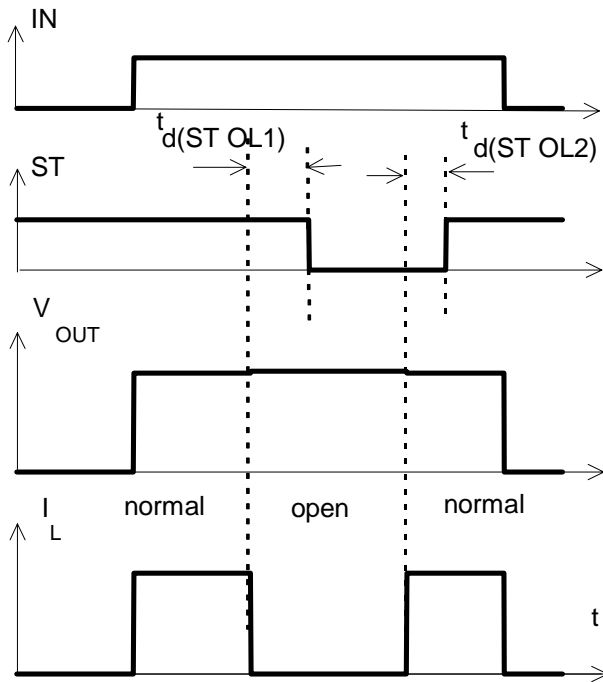


\*) ST goes high, when  $V_{IN} = \text{low}$  and  $T_j < T_{jt}$

**Figure 5a:** Open load: detection in ON-state, turn on/off to open load

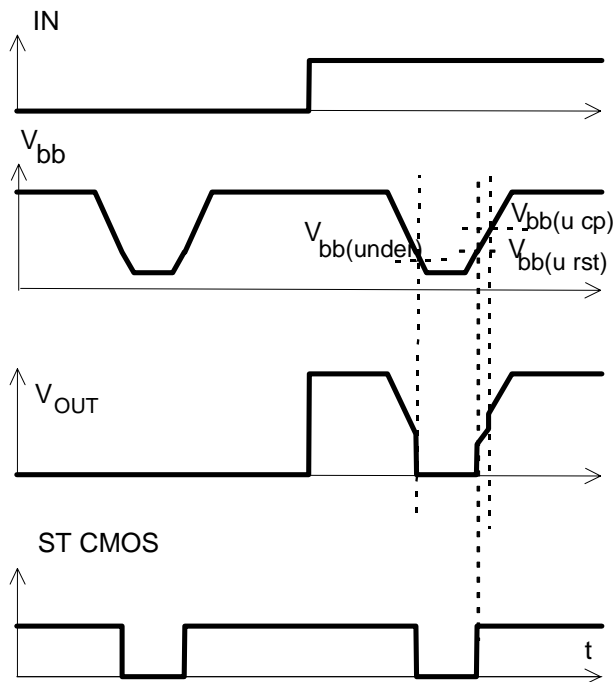


**Figure 5b:** Open load: detection in ON-state, open load occurs in on-state

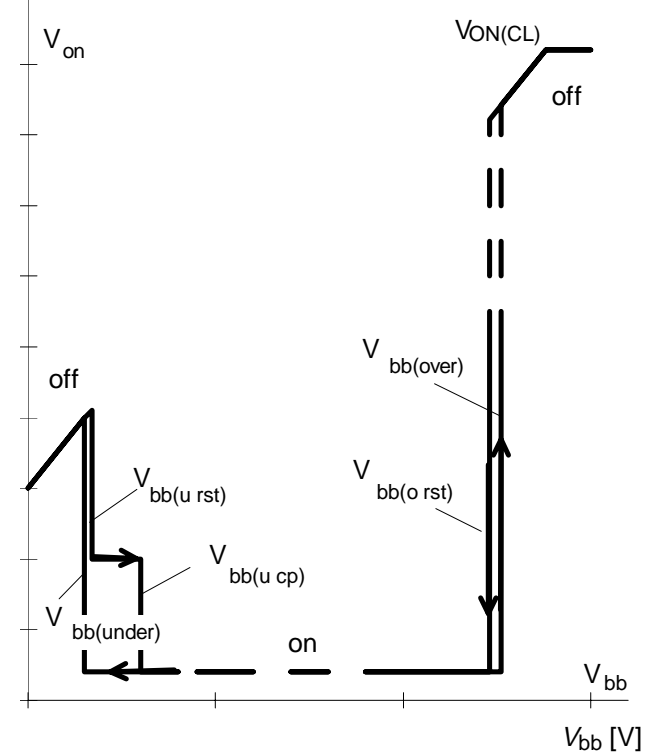


$t_{d(ST OL1)} = t_{bd} \mu s \text{ typ.}$ ,  $t_{d(ST OL2)} = t_{bd} \mu s \text{ typ}$

**Figure 6a:** Undervoltage:

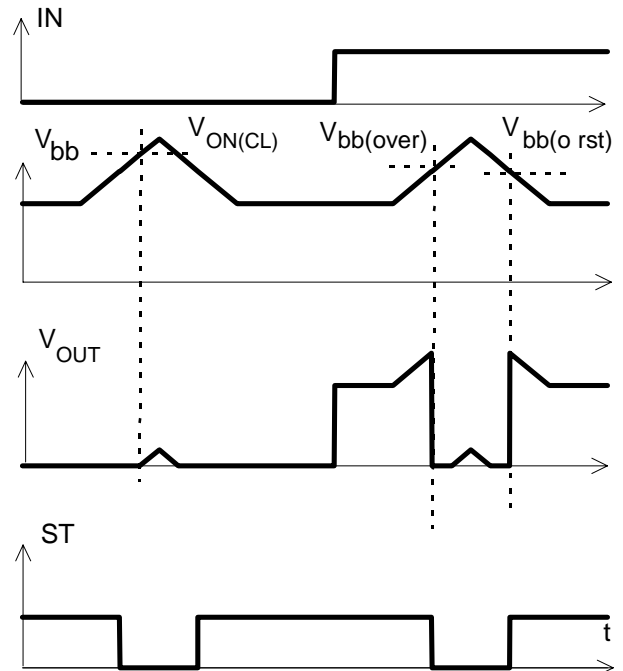


**Figure 6b:** Undervoltage restart of charge pump



charge pump starts at  $V_{bb(ucp)} = 6.5 \text{ V typ.}$

**Figure 7a:** Overvoltage:





Published by Siemens AG, Bereich Halbleiter Vertrieb, Werbung,  
Balanstraße 73, D-81541 München

© Siemens AG 1999. All Rights Reserved

**Attention please!**

As far as patents or other rights of third parties are concerned, liability is only assumed for components, not for applications, processes and circuits implemented within components or assemblies. The information describes a type of component and shall not be considered as warranted characteristics. Terms of delivery and rights to change design reserved. For questions on technology, delivery and prices please contact the Semiconductor Group Offices in Germany or the Siemens Companies and Representatives worldwide (see address list). Due to technical requirements components may contain dangerous substances. For information on the types in question please contact your nearest Siemens Office, Semiconductor Group. Siemens AG is an approved CECC manufacturer.

**Packing:** Please use the recycling operators known to you. We can also help you - get in touch with your nearest sales office. By agreement we will take packing material back, if it is sorted. You must bear the costs of transport. For packing material that is returned to us unsorted or which we are not obliged to accept, we shall have to invoice you for any costs incurred.

**Components used in life-support devices or systems must be expressly authorised for such purpose!** Critical components<sup>20)</sup> of the Semiconductor Group of Siemens AG, may only be used in life supporting devices or systems<sup>21)</sup> with the express written approval of the Semiconductor Group of Siemens AG.

---

20) A critical component is a component used in a life-support device or system whose failure can reasonably be expected to cause the failure of that life-support device or system, or to affect its safety or effectiveness of that device or system.

21) Life support devices or systems are intended (a) to be implanted in the human body or (b) support and/or maintain and sustain and/or protect human life. If they fail, it is reasonably to assume that the health of the user or other persons may be endangered.