

**HIGH VOLTAGE FASTSWITCHING NPN  
POWER TRANSISTOR**

- SGS-THOMSON PREFERRED SALESTYPE
- HIGH VOLTAGE CAPABILITY
- U.L. RECOGNISED ISOWATT218 PACKAGE (U.L. FILE # E81734 (N)).

**APPLICATIONS:**

- HORIZONTAL DEFLECTION FOR COLOUR TV
- SWITCH MODE POWER SUPPLIES

**DESCRIPTION**

The BUH313 is manufactured using Multi-epitaxial Mesa technology for cost-effective high performance and uses a Hollow Emitter structure to enhance switching speeds.

The BUH series is designed for use in horizontal deflection circuits in televisions and monitors.

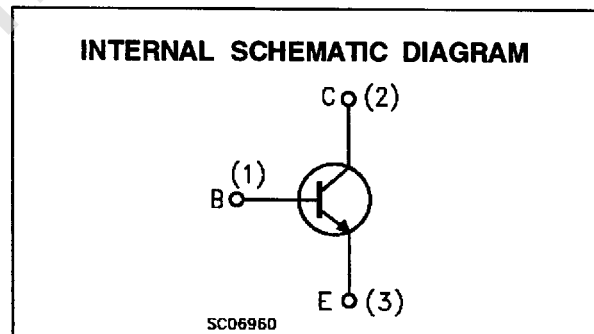
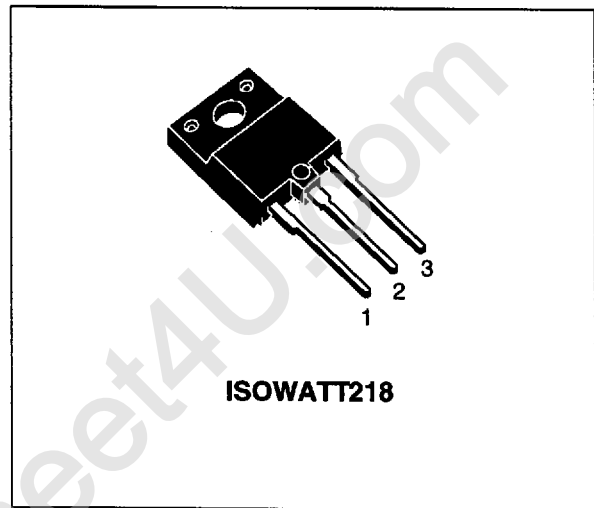

**ABSOLUTE MAXIMUM RATINGS**

Symbol	Parameter	Value	Unit
$V_{CBO}$	Collector-Base Voltage ( $I_E = 0$ )	1300	V
$V_{CEO}$	Collector-Emitter Voltage ( $I_B = 0$ )	600	V
$V_{EBO}$	Emitter-Base Voltage ( $I_C = 0$ )	10	V
$I_C$	Collector Current	5	A
$I_{CM}$	Collector Peak Current ( $t_p < 5$ ms)	8	A
$I_B$	Base Current	3	A
$I_{BM}$	Base Peak Current ( $t_p < 5$ ms)	5	A
$P_{tot}$	Total Dissipation at $T_c = 25$ °C	44	W
$T_{stg}$	Storage Temperature	-65 to 150	°C
$T_j$	Max. Operating Junction Temperature	150	°C

**THERMAL DATA**

R <sub>thj-case</sub>	Thermal Resistance Junction-case	Max	2.8	°C/W
-----------------------	----------------------------------	-----	-----	------

**ELECTRICAL CHARACTERISTICS** (T<sub>case</sub> = 25 °C unless otherwise specified)

Symbol	Parameter	Test Conditions	Min.	Typ.	Max.	Unit
I <sub>CES</sub>	Collector Cut-off Current (V <sub>BE</sub> = 0)	V <sub>CE</sub> = 1300 V V <sub>CE</sub> = 1300 V T <sub>j</sub> = 125 °C			1 2	mA mA
I <sub>EBO</sub>	Emitter Cut-off Current (I <sub>C</sub> = 0)	V <sub>EB</sub> = 5 V			100	μA
V <sub>CEO(sus)</sub>	Collector-Emitter Sustaining Voltage	I <sub>C</sub> = 100 mA	600			V
V <sub>EBO</sub>	Emitter-Base Voltage (I <sub>C</sub> = 0)	I <sub>E</sub> = 10 mA	10			V
V <sub>CE(sat)*</sub>	Collector-Emitter Saturation Voltage	I <sub>C</sub> = 3 A I <sub>B</sub> = 0.75 A			1.5	V
V <sub>BE(sat)*</sub>	Base-Emitter Saturation Voltage	I <sub>C</sub> = 3 A I <sub>B</sub> = 0.75 A			1.3	V
h <sub>FE*</sub>	DC Current Gain	I <sub>C</sub> = 3 A V <sub>CE</sub> = 5 V I <sub>C</sub> = 3 A V <sub>CE</sub> = 5 V T <sub>j</sub> = 100 °C	5.5 3.5			
t <sub>s</sub> t <sub>f</sub>	RESISTIVE LOAD Storage Time Fall Time	V <sub>CC</sub> = 400 V I <sub>C</sub> = 3 A I <sub>B1</sub> = 0.75 A I <sub>B2</sub> = 1.5 A		1.6 110	2.4 200	μs ns
t <sub>s</sub> t <sub>f</sub>	INDUCTIVE LOAD Storage Time Fall Time	I <sub>C</sub> = 3 A f = 15625 Hz I <sub>B1</sub> = 0.75 A I <sub>B2</sub> = -1.5 A V <sub>ceflyback</sub> = 1050 sin(π/5 10 <sup>6</sup> t) V		3.5 340		μs ns
t <sub>s</sub> t <sub>f</sub>	INDUCTIVE LOAD Storage Time Fall Time	I <sub>C</sub> = 3 A f = 31250 Hz I <sub>B1</sub> = 0.75 A I <sub>B2</sub> = -1.5 A V <sub>ceflyback</sub> = 1200 sin(π/5 10 <sup>6</sup> t) V		3.5 270		μs ns

\* Pulsed: Pulse duration = 300 μs, duty cycle 1.5 %

**Safe Operating Area**

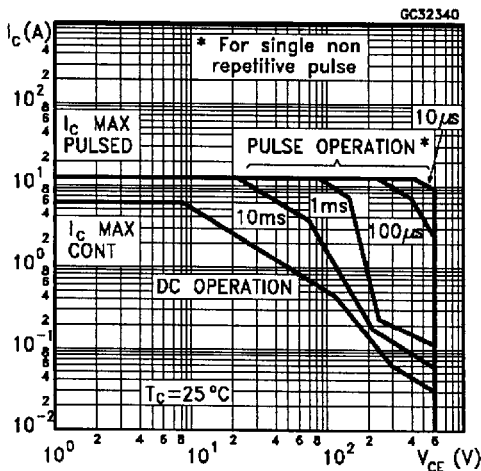

**Thermal Impedance**

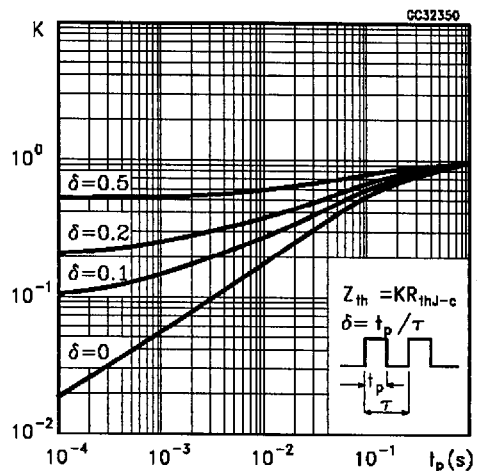

Derating Curve

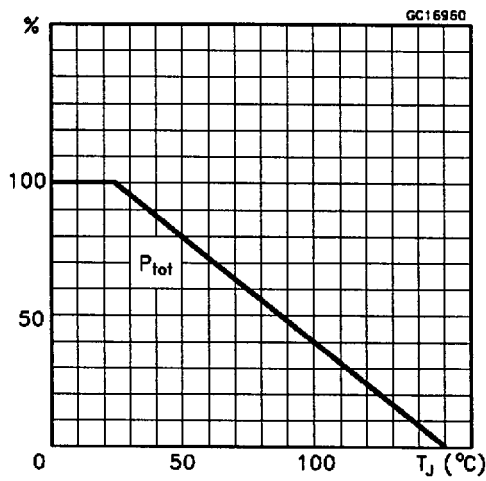

DC Current Gain

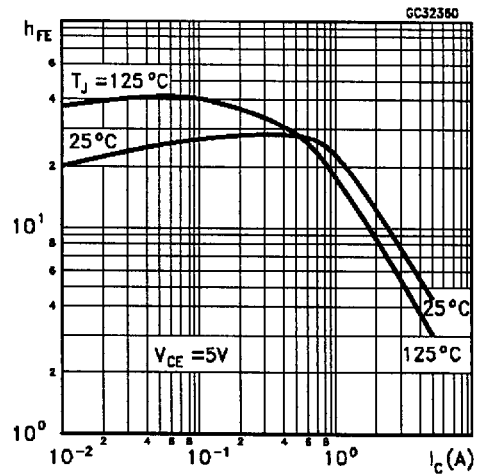

Collector Emitter Saturation Voltage

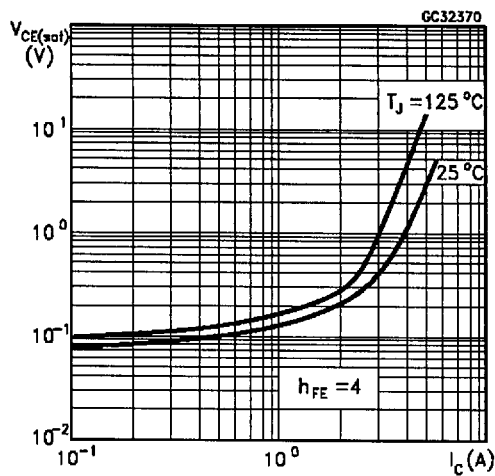

Base Emitter Saturation Voltage

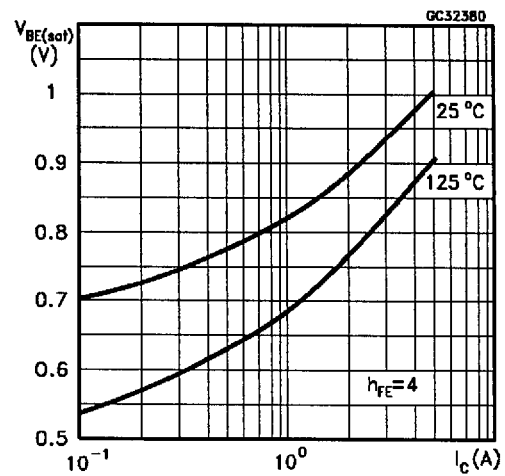

Power Losses at 16 KHz

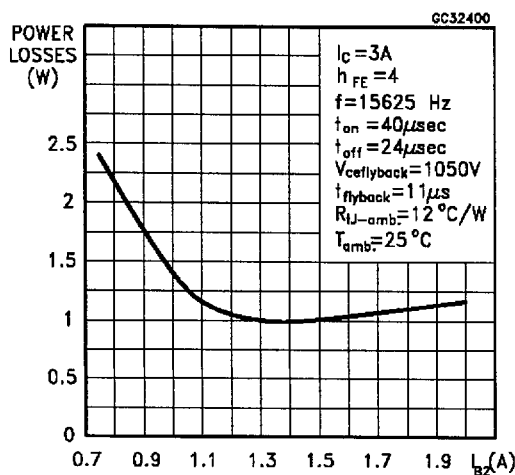

Switching Time Inductive Load at 16KHz (see figure 2)

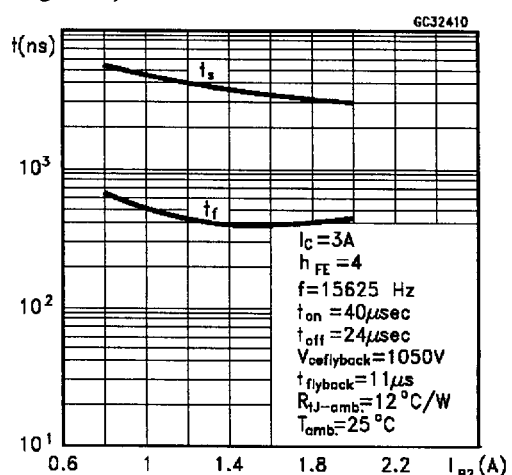

Power Losses at 32 KHz

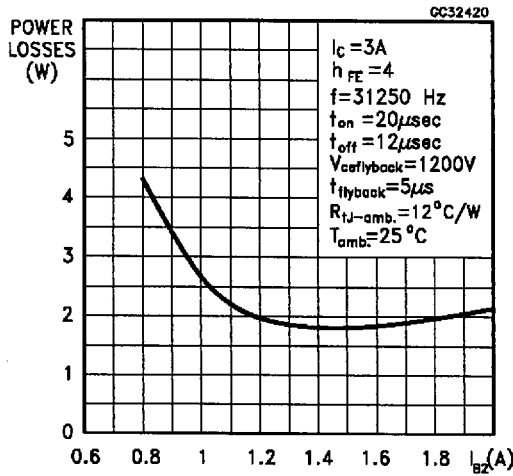

Switching Time Inductive Load at 32 KHz (see figure 2)

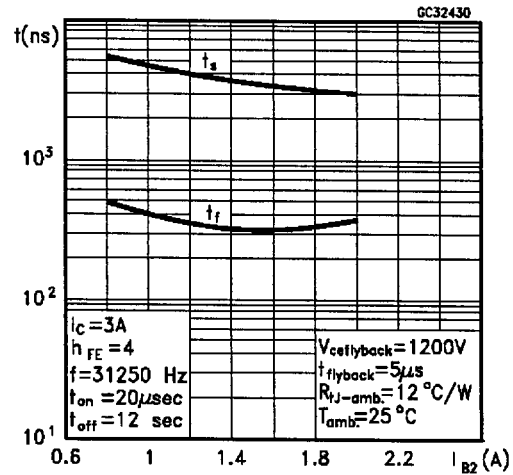

Reverse Biased SOA

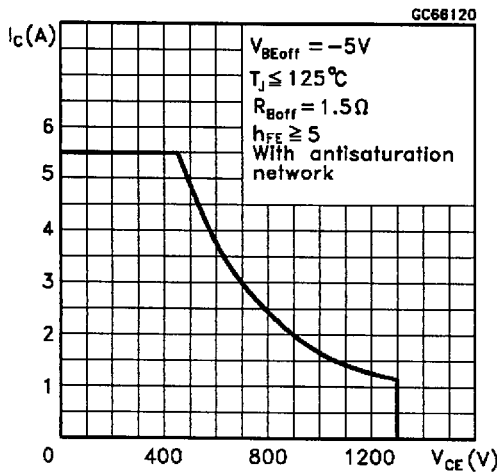

BASE DRIVE INFORMATION

In order to saturate the power switch and reduce conduction losses, adequate direct base current  $I_{B1}$  has to be provided for the lowest gain  $h_{FE}$  at 100 °C (line scan phase). On the other hand, negative base current  $I_{B2}$  must be provided to turn off the power transistor (retrace phase).

Most of the dissipation, in the deflection application, occurs at switch-off. Therefore it is essential to determine the value of  $I_{B2}$  which minimizes power losses, fall time  $t_f$  and, consequently,  $T_j$ . A new set of curves have been defined to give total power losses,  $t_s$  and  $t_f$  as a function of  $I_{B2}$  at both 16 KHz, 32 KHz and 64KHz scanning frequencies for choosing the optimum negative drive. The test circuit is

illustrated in figure 1.

Inductance  $L_1$  serves to control the slope of the negative base current  $I_{B2}$  to recombine the excess carrier in the collector when base current is still present, this would avoid any tailing phenomenon in the collector current.

The values of  $L$  and  $C$  are calculated from the following equations:

$$\frac{1}{2} L (I_C)^2 = \frac{1}{2} C (V_{CEfly})^2 \quad \omega = 2 \pi f = \frac{1}{\sqrt{LC}}$$

Where  $I_C$  = operating collector current,  $V_{CEfly}$  = flyback voltage,  $f$  = frequency of oscillation during retrace.

Figure 1: Inductive Load Switching Test Circuits.

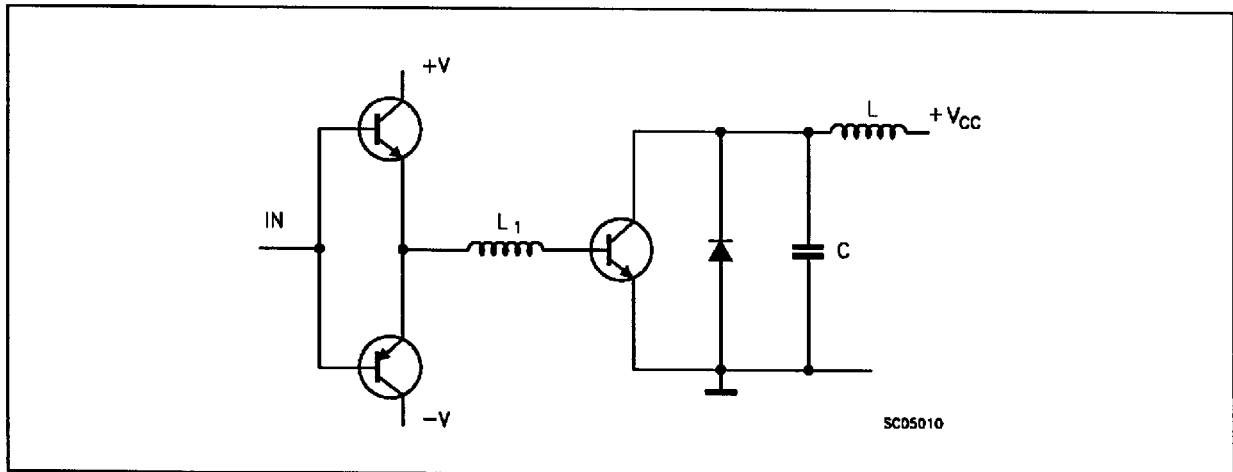
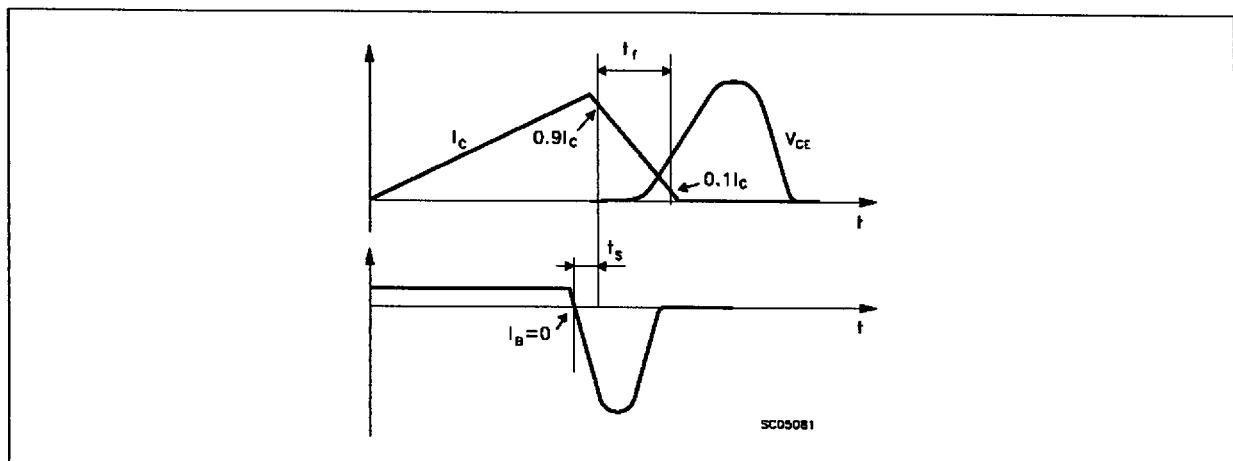

Figure 2: Switching Waveforms in a Deflection Circuit



**ISOWATT218 MECHANICAL DATA**

DIM.	mm			inch		
	MIN.	TYP.	MAX.	MIN.	TYP.	MAX.
A	5.35		5.65	0.210		0.222
C	3.3		3.8	0.130		0.149
D	2.9		3.1	0.114		0.122
D1	1.88		2.08	0.074		0.081
E	0.45		1	0.017		0.039
F	1.05		1.25	0.041		0.049
G	10.8		11.2	0.425		0.441
H	15.8		16.2	0.622		0.637
L1	20.8		21.2	0.818		0.834
L2	19.1		19.9	0.752		0.783
L3	22.8		23.6	0.897		0.929
L4	40.5		42.5	1.594		1.673
L5	4.85		5.25	0.190		0.206
L6	20.25		20.75	0.797		0.817
M	3.5		3.7	0.137		0.145
N	2.1		2.3	0.082		0.090
U		4.6			0.181	

