

Features

- 120MHz gain-bandwidth product
- Unity-gain stable
- Low supply current (per amplifier) - 5.2mA at $V_S = \pm 15V$
- Wide supply range - $\pm 2V$ to $\pm 18V$ dual-supply, 2.5V to 36V single-supply
- High slew rate - 325V/ μs
- Fast settling - 80ns to 0.1% for a 10V step
- Low differential gain - 0.04% at $A_V = +2, R_L = 150\Omega$
- Low differential phase - 0.15° at $A_V = +2, R_L = 150\Omega$
- Stable w/ unlimited capacitive load
- Wide output voltage swing - $\pm 13.6V$ with $V_S = \pm 15V, R_L = 1000\Omega$, 3.8V/0.3V with $V_S = +5V, R_L = 500\Omega$
- Low cost, enhanced replacement for the AD827 and LT1229/LT1230

Applications

- Video amplifier
- Single-supply amplifier
- Active filters/integrators
- High-speed sample-and-hold
- High-speed signal processing
- ADC/DAC buffer
- Pulse/RF amplifier
- Pin diode receiver
- Log amplifier
- Photo multiplier amplifier
- Difference amplifier

Ordering Information

| Part No. | Temp. Range | Package | Outline # |
|----------|----------------|--------------|-----------|
| EL2244CN | -40°C to +85°C | 8-Pin P-DIP | MDP0031 |
| EL2244CS | -40°C to +85°C | 8-Lead SO | MDP0027 |
| EL2444CN | -40°C to +85°C | 14-Pin P-DIP | MDP0031 |
| EL2444CS | -40°C to +85°C | 14-Lead SO | MDP0027 |
| EL2444CM | -40°C to +85°C | 16-Lead SOL | MDP0027 |

General Description

The EL2244C/EL2444C are dual and quad versions of the popular EL2044C. They are high speed, low power, low cost monolithic operational amplifiers built on Elantec's proprietary complementary bipolar process. The EL2244C/EL2444C are unity-gain stable and feature a 325V/ μs slew rate and 120MHz gain-bandwidth product while requiring only 5.2mA of supply current per amplifier.

The power supply operating range of the EL2244C/EL2444C is from $\pm 18V$ down to as little as $\pm 2V$. For single-supply operation, the EL2244C/EL2444C operate from 36V down to as little as 2.5V. The excellent power supply operating range of the EL2244C/EL2444C makes them an obvious choice for applications on a single +5V or +3V supply.

The EL2244C/EL2444C also feature an extremely wide output voltage swing of $\pm 13.6V$ with $V_S = \pm 15V$ and $R_L = 1000\Omega$. At $\pm 5V$, output voltage swing is a wide $\pm 3.8V$ with $R_L = 500\Omega$ and $\pm 3.2V$ with $R_L = 150\Omega$. Furthermore, for single-supply operation at +5V, output voltage swing is an excellent 0.3V to 3.8V with $R_L = 500\Omega$.

At a gain of +1, the EL2244C/EL2444C have a -3dB bandwidth of 120MHz with a phase margin of 50° . They can drive unlimited load capacitance, and because of their conventional voltage-feedback topology, the EL2244C/EL2444C allow the use of reactive or non-linear elements in their feedback network. This versatility combined with low cost and 75mA of output-current drive make the EL2244C/EL2444C an ideal choice for price-sensitive applications requiring low power and high speed.

Connection Diagrams

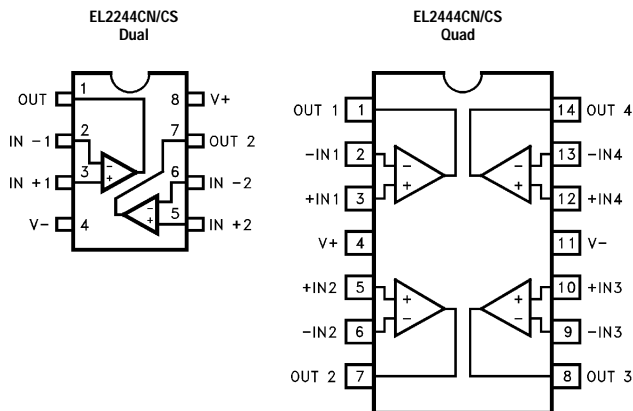

Note: All information contained in this data sheet has been carefully checked and is believed to be accurate as of the date of publication; however, this data sheet cannot be a "controlled document". Current revisions, if any, to these specifications are maintained at the factory and are available upon your request. We recommend checking the revision level before finalization of your design documentation.

EL2244C, EL2444C**Dual/Quad Low-Power 120MHz Unity-Gain Stable Op Amp****Absolute Maximum Ratings** ($T_A = 25^\circ\text{C}$)

| | | | |
|--|----------------------------------|--|---|
| Supply Voltage (V_S) | $\pm 18\text{V}$ or 36V | Differential Input Voltage (dV_{IN}) | $\pm 10\text{V}$ |
| Peak Output Current (I_{OP}) | Short-Circuit Protected | Power Dissipation (P_D) | See Curves |
| Output Short-Circuit Duration | Infinite | Operating Temperature Range (T_A) | -40°C to $+85^\circ\text{C}$ |
| A heat-sink is required to keep junction temperature below absolute maximum when an output is shorted. | | Operating Junction Temperature (T_J) | 150°C |
| Input Voltage (V_{IN}) | $\pm V_S$ | Storage Temperature (T_{ST}) | -65°C to $+150^\circ\text{C}$ |

Important Note:

All parameters having Min/Max specifications are guaranteed. Typ values are for information purposes only. Unless otherwise noted, all tests are at the specified temperature and are pulsed tests, therefore: $T_J = T_C = T_A$.

DC Electrical Characteristics

$V_S = \pm 15\text{V}$, $R_L = 1000\Omega$, unless otherwise specified

| Parameter | Description | Condition | Temp | Min | Typ | Max | Unit |
|------------|--------------------------------|--|-----------------------|--------------------|------------|------|------------------------------|
| V_{OS} | Input Offset Voltage | $V_S = \pm 15\text{V}$ | 25°C | | 0.5 | 4.0 | mV |
| | | | T_{MIN}, T_{MAX} | | | 9.0 | mV |
| TCV_{OS} | Average Offset Voltage Drift | [1] | All | | 10.0 | | $\mu\text{V}/^\circ\text{C}$ |
| I_B | Input Bias Current | $V_S = \pm 15\text{V}$ | 25°C | | 2.8 | 8.2 | μA |
| | | | T_{MIN}, T_{MAX} | | | 11.2 | μA |
| I_{OS} | Input Offset Current | $V_S = \pm 15\text{V}$ | 25°C | | 50 | 300 | nA |
| | | | T_{MIN}, T_{MAX} | | | 500 | nA |
| | | | $V_S = \pm 5\text{V}$ | 25°C | | 50 | |
| TCI_{OS} | Average Offset Current Drift | [1] | All | | 0.3 | | $\text{nA}/^\circ\text{C}$ |
| A_{VOL} | Open-Loop Gain | $V_S = \pm 15\text{V}, V_{OUT} = \pm 10\text{V}, R_L = 1000\Omega$ | 25°C | 800 | 1500 | | V/V |
| | | | T_{MIN}, T_{MAX} | 600 | | | V/V |
| | | $V_S = \pm 5\text{V}, V_{OUT} = \pm 2.5\text{V}, R_L = 500\Omega$ | 25°C | | 1200 | | V/V |
| | | | 25°C | | 1000 | | V/V |
| $PSRR$ | Power Supply Rejection Ratio | $V_S = \pm 5\text{V}$ to $\pm 15\text{V}$ | 25°C | 65 | 80 | | dB |
| | | | T_{MIN}, T_{MAX} | 60 | | | dB |
| $CMRR$ | Common-Mode Rejection Ratio | $V_{CM} = \pm 12\text{V}, V_{OUT} = 0\text{V}$ | 25°C | 70 | 90 | | dB |
| | | | T_{MIN}, T_{MAX} | 70 | | | dB |
| $CMIR$ | Common-Mode Input Range | $V_S = \pm 15\text{V}$ | 25°C | | ± 14.0 | | V |
| | | | 25°C | | ± 4.2 | | V |
| | | | 25°C | | 4.2/0.1 | | V |
| V_{OUT} | Output Voltage Swing | $V_S = \pm 15\text{V}, R_L = 1000\Omega$ | 25°C | ± 13.4 | ± 13.6 | | V |
| | | | T_{MIN}, T_{MAX} | ± 13.1 | | | V |
| | | $V_S = \pm 15\text{V}, R_L = 500\Omega$ | 25°C | ± 12.0 | ± 13.4 | | V |
| | | | 25°C | ± 3.4 | ± 3.8 | | V |
| | | $V_S = \pm 5\text{V}, R_L = 150\Omega$ | 25°C | | ± 3.2 | | V |
| | | | 25°C | 3.6/0.4 | 3.8/0.3 | | V |
| I_{SC} | Output Short Circuit Current | | 25°C | 40 | 75 | | mA |
| | | | T_{MIN}, T_{MAX} | 35 | | | mA |
| I_S | Supply Current (Per Amplifier) | $V_S = \pm 15\text{V}$, No Load | 25°C | | 5.2 | 7 | mA |
| | | | T_{MIN} | | | 7.6 | mA |
| | | | T_{MAX} | | | 7.6 | mA |
| | | $V_S = \pm 5\text{V}$, No Load | 25°C | | 5.0 | | mA |

EL2244C, EL2444C

Dual/Quad Low-Power 120MHz Unity-Gain Stable Op Amp

EL2244C, EL2444C

DC Electrical Characteristics (Continued)

$V_S = \pm 15V$, $R_L = 1000\Omega$, unless otherwise specified

| Parameter | Description | Condition | Temp | Min | Typ | Max | Unit |
|------------------|---------------------------------|----------------------------|------|------|-----|-------|------|
| R _{IN} | Input Resistance | Differential | 25°C | | 150 | | kΩ |
| | | Common-Mode | 25°C | | 15 | | MΩ |
| C _{IN} | Input Capacitance | A _v = +1@ 10MHz | 25°C | | 1.0 | | pF |
| R _{OUT} | Output Resistance | A _v = +1 | 25°C | | 50 | | mΩ |
| PSOR | Power-Supply Operating Range | Dual-Supply | 25°C | ±2.0 | | ±18.0 | V |
| | | Single-Supply | 25°C | 2.5 | | 36.0 | V |

1. Measured from T_{MIN} to T_{MAX}.

EL2244C, EL2444C**Dual/Quad Low-Power 120MHz Unity-Gain Stable Op Amp****Closed-Loop AC Electrical Characteristics** $V_S = \pm 15V$, $A_V = +1$, $R_L = 1000\Omega$ unless otherwise specified

| Parameter | Description | Condition | Temp | Min | Typ | Max | Unit |
|---------------|---|--|------|-----|----------|-----|------------------------|
| BW | -3dB Bandwidth ($V_{OUT} = 0.4V_{pp}$) | $V_S = \pm 15V$, $A_V = +1$ | 25°C | | 120 | | MHz |
| | | $V_S = \pm 15V$, $A_V = -1$ | 25°C | | 60 | | MHz |
| | | $V_S = \pm 15V$, $A_V = +2$ | 25°C | | 60 | | MHz |
| | | $V_S = \pm 15V$, $A_V = +5$ | 25°C | | 12 | | MHz |
| | | $V_S = \pm 15V$, $A_V = +10$ | 25°C | | 6 | | MHz |
| | | $V_S = \pm 5V$, $A_V = +1$ | 25°C | | 80 | | MHz |
| GBWP | Gain-Bandwidth Product | $V_S = \pm 15V$ | 25°C | | 60 | | MHz |
| | | $V_S = \pm 5V$ | 25°C | | 45 | | MHz |
| PM | Phase Margin | $R_L = 1\text{ k}\Omega$, $C_L = 10\text{pF}$ | 25°C | | 50 | | ° |
| CS | Channel Separation | $f = 5\text{MHz}$ | 25°C | | 85 | | dB |
| SR | Slew Rate ^[1] | $V_S = \pm 15V$, $R_L = 1000\Omega$ | 25°C | 250 | 325 | | V/ μ s |
| | | $V_S = \pm 5V$, $R_L = 500\Omega$ | 25°C | | 200 | | V/ μ s |
| FPBW | Full-Power Bandwidth ^[2] | $V_S = \pm 15V$ | 25°C | 4.0 | 5.2 | | MHz |
| | | $V_S = \pm 5V$ | 25°C | | 12.7 | | MHz |
| t_r , t_f | Rise Time, Fall Time | 0.1V Step | 25°C | | 3.0 | | ns |
| OS | Overshoot | 0.1V Step | 25°C | | 20 | | % |
| tpD | Propagation Delay | | 25°C | | 2.5 | | ns |
| t_s | Settling to +0.1% ($A_V = +1$) | $V_S = \pm 15V$, 10V Step | 25°C | | 80 | | ns |
| | | $V_S = \pm 5V$, 5V Step | 25°C | | 60 | | ns |
| dG | Differential Gain ^[3] | NTSC/PAL | 25°C | | 0.04 | | % |
| dP | Differential Phase ^[3] | NTSC/PAL | 25°C | | 0.15 | | ° |
| eN | Input Noise Voltage | 10kHz | 25°C | | 15.0 | | nV/ $\sqrt{\text{Hz}}$ |
| iN | Input Noise Current | 10kHz | 25°C | | 1.50 | | pA/ $\sqrt{\text{Hz}}$ |
| CI STAB | Load Capacitance Stability | $A_V = +1$ | 25°C | | Infinite | | pF |

- Slew rate is measured on rising edge
- For $V_S = \pm 15V$, $V_{OUT} = 20V_{pp}$. For $V_S = \pm 5V$, $V_{OUT} = 5V_{pp}$. Full-power bandwidth is based on slew rate measurement using: $FPBW = SR/(2\pi * V_{peak})$.
- Video Performance measured at $V_S = \pm 15V$, $A_V = +2$ with 2 times normal video level across $R_L = 150\Omega$. This corresponds to standard video levels across a back-terminated 75 Ω load. For other values of R_L , see curves.

EL2244C, EL2444C

Dual/Quad Low-Power 120MHz Unity-Gain Stable Op Amp

EL2244C, EL2444C

Typical Performance Curves

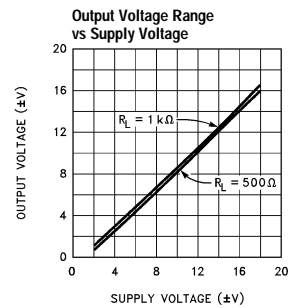
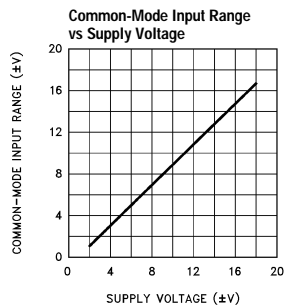
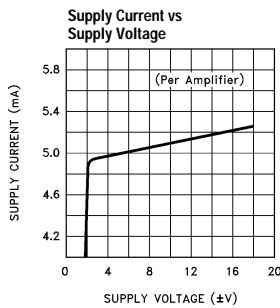
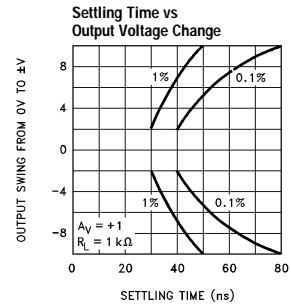
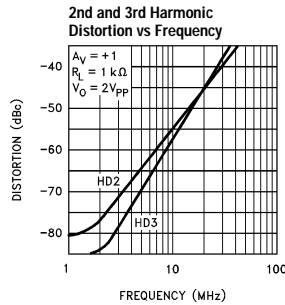
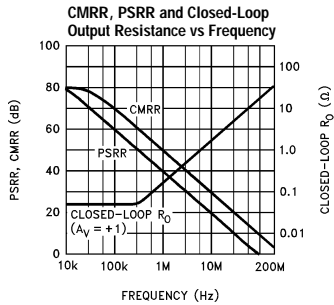
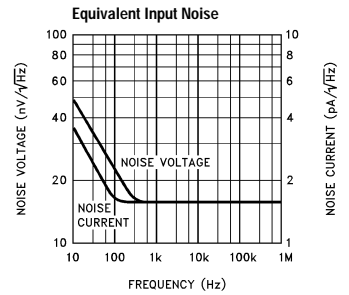
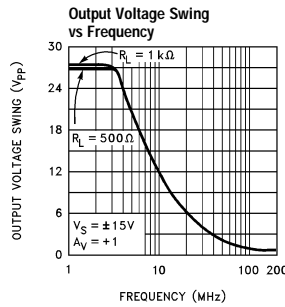
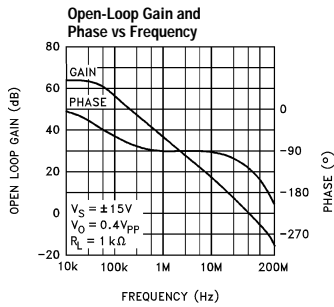
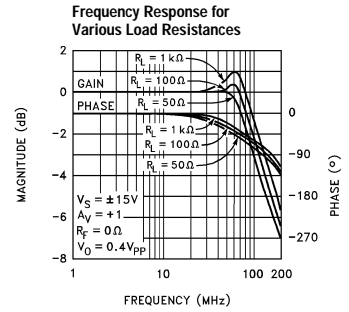
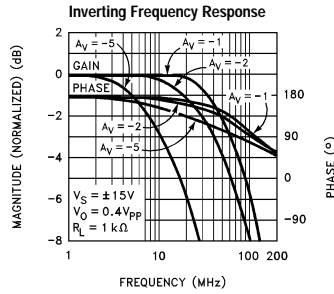
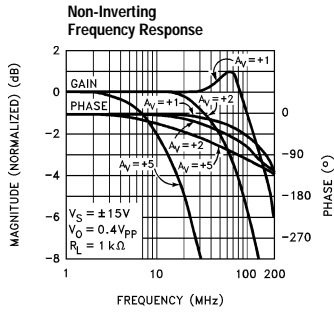

EL2244C, EL2444C

Dual/Quad Low-Power 120MHz Unity-Gain Stable Op Amp

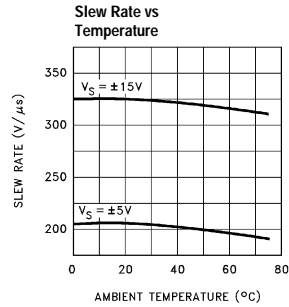
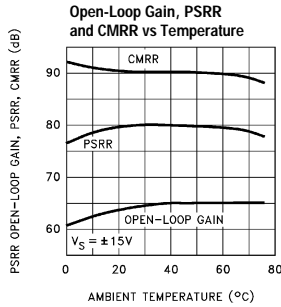
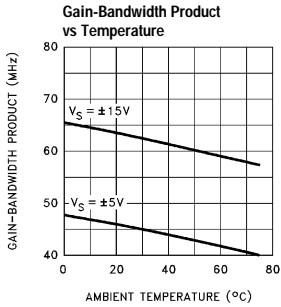
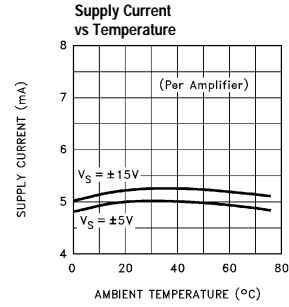
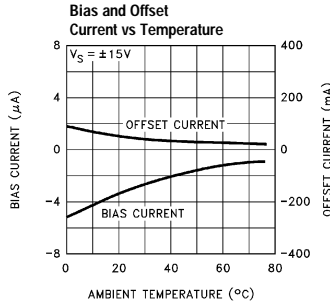
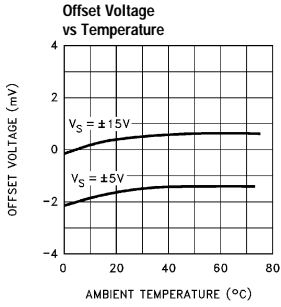
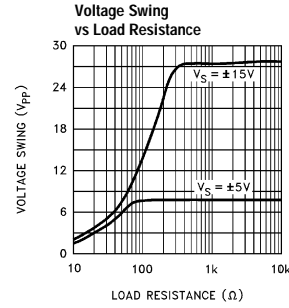
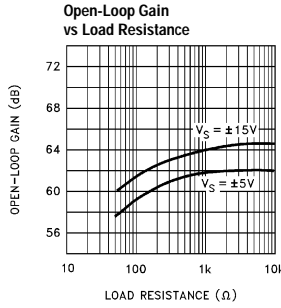
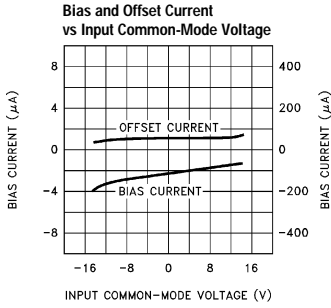
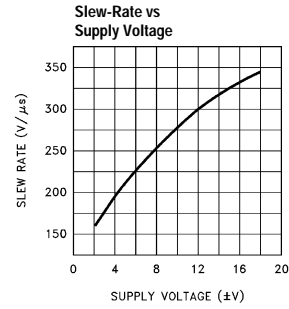
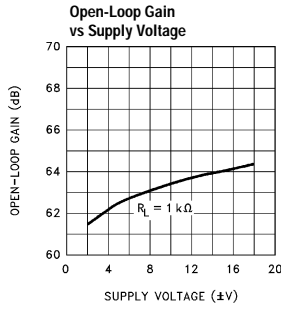
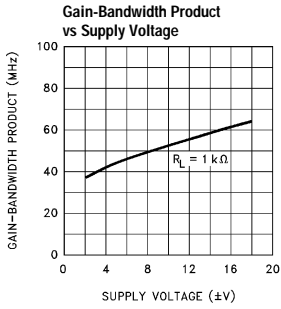

EL2244C, EL2444C

Dual/Quad Low-Power 120MHz Unity-Gain Stable Op Amp

EL2244C, EL2444C

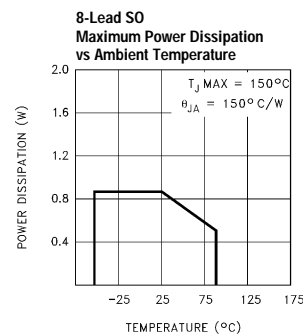
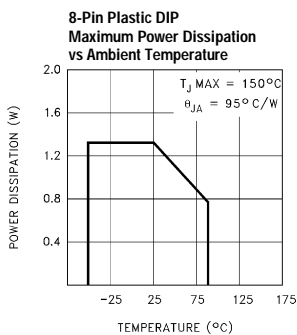
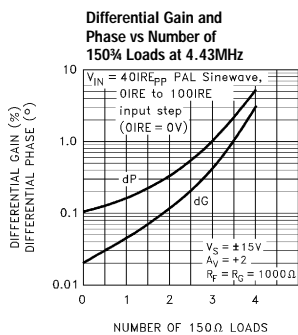
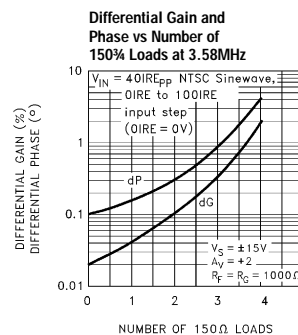
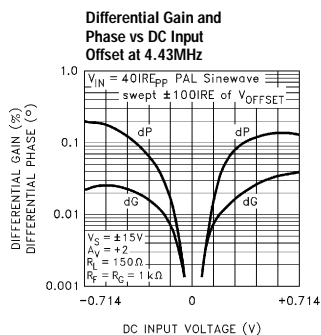
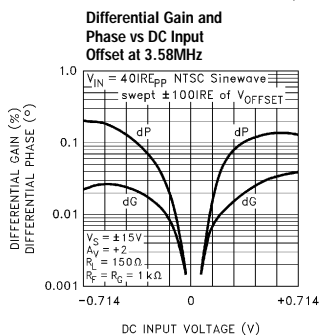
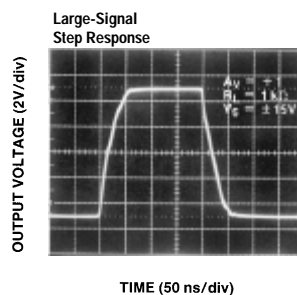
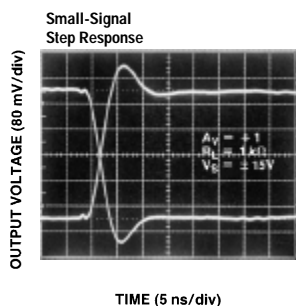
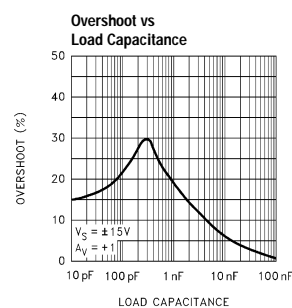
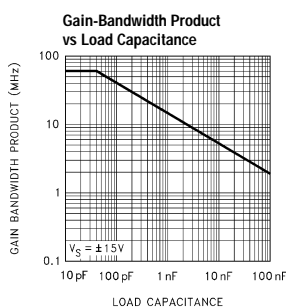
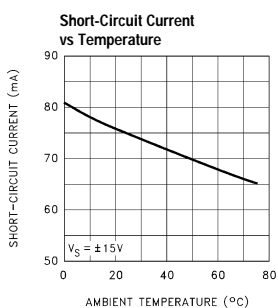

EL2244C, EL2444C

Dual/Quad Low-Power 120MHz Unity-Gain Stable Op Amp

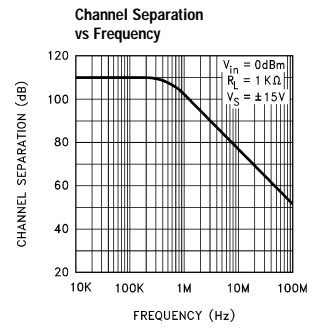
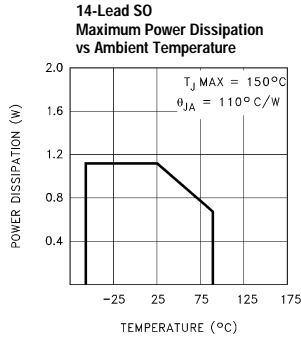
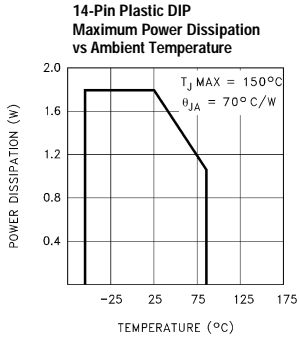

Simplified Schematic (Per Amplifier)

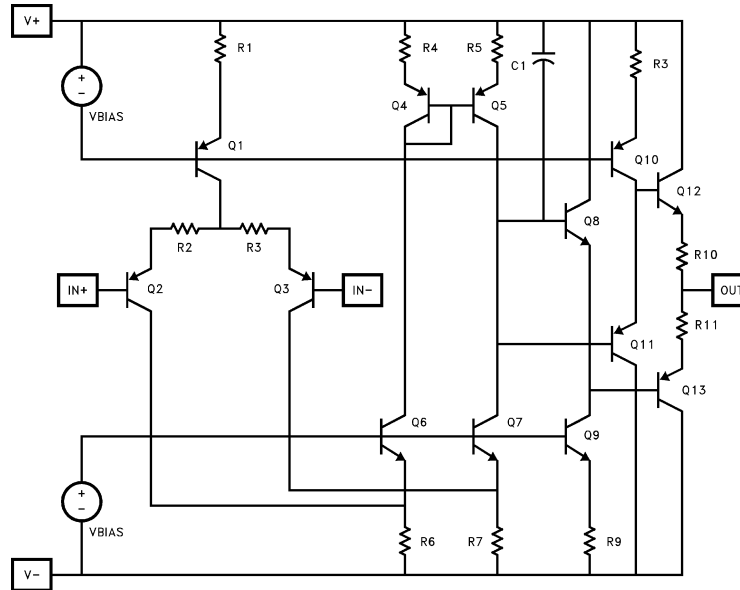

EL2244C, EL2444C

Dual/Quad Low-Power 120MHz Unity-Gain Stable Op Amp

EL2244C, EL2444C

Burn-In Circuit (Per Amplifier)

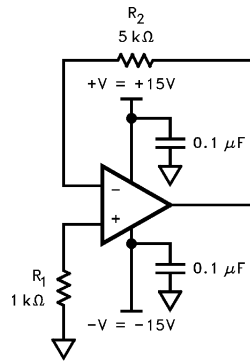

All Packages Use the Same Schematic

EL2244C, EL2444C

Dual/Quad Low-Power 120MHz Unity-Gain Stable Op Amp

Applications Information

Product Description

The EL2244C/EL2444C are low-power wideband monolithic operational amplifiers built on Elantec's proprietary high-speed complementary bipolar process. The EL2244C/EL2444C use a classical voltage-feedback topology which allows them to be used in a variety of applications where current-feedback amplifiers are not appropriate because of restrictions placed upon the feedback element used with the amplifier. The conventional topology of the EL2244C/EL2444C allows, for example, a capacitor to be placed in the feedback path, making it an excellent choice for applications such as active filters, sample-and-holds, or integrators. Similarly, because of the ability to use diodes in the feedback network, the EL2244C/EL2444C are an excellent choice for applications such as fast log amplifiers.

Power Dissipation

With the wide power supply range and large output drive capability of the EL2244C/EL2444C, it is possible to exceed the 150°C maximum junction temperatures under certain load and power-supply conditions. It is therefore important to calculate the maximum junction temperature (T_{Jmax}) for all applications to determine if power supply voltages, load conditions, or package type need to be modified for the EL2244C/EL2444C to remain in the safe operating area. These parameters are related as follows:

$$T_{Jmax} = T_{max} + (\theta_{JA} * (PD_{maxtotal}))$$

where $PD_{maxtotal}$ is the sum of the maximum power dissipation of each amplifier in the package (PD_{max}). PD_{max} for each amplifier can be calculated as follows:

$$PD_{max} = (2 * V_S * I_{Smax} + (V_S - V_{outmax}) * (V_{outmax} / R_L))$$

where:

T_{max} = Maximum Ambient Temperature

θ_{JA} = Thermal Resistance of the Package

PD_{max} = Maximum Power Dissipation of 1 Amplifier

V_S = Supply Voltage

I_{Smax} = Maximum Supply Current of 1 Amplifier

V_{outmax} = Maximum Output Voltage Swing of the Application

R_L = Load Resistance

To serve as a guide for the user, we can calculate maximum allowable supply voltages for the example of the video cable-driver below since we know that $T_{Jmax} = 150^\circ\text{C}$, $T_{max} = 75^\circ\text{C}$, $I_{Smax} = 7.6\text{mA}$, and the package θ_{JA} s are shown in Table 1. If we assume (for this example) that we are driving a back-terminated video cable, then the maximum average value (over duty-cycle) of V_{outmax} is 1.4V, and $R_L = 150\Omega$, giving the results seen in Table 1.

Table 1

| Duals | Package | θ_{JA} | Max PDiss @ T_{max} | Max V_S |
|----------|---------|---------------|-----------------------|-----------|
| EL2244CN | PDIP8 | 95°C/W | 0.789W @ 75°C | ±16.6V |
| EL2244CS | SO8 | 150°C/W | 0.500W @ 75°C | ±10.7V |
| QUADS | | | | |
| EL2444CN | PDIP14 | 70°C/W | 1.071W @ 75°C | ±11.5V |
| EL2444CS | SO14 | 110°C/W | 0.682W @ 75°C | ±7.5V |

Single-Supply Operation

The EL2244C/EL2444C have been designed to have a wide input and output voltage range. This design also makes the EL2244C/EL2444C an excellent choice for single-supply operation. Using a single positive supply, the lower input voltage range is within 100mV of ground ($R_L = 500\Omega$), and the lower output voltage range is within 300 mV of ground. Upper input voltage range reaches 4.2V, and output voltage range reaches 3.8V with a 5V supply and $R_L = 500\Omega$. This results in a 3.5V output swing on a single 5V supply. This wide output voltage range also allows single-supply operation with a supply voltage as high as 36V or as low as 2.5V. On a single 2.5V supply, the EL2244C/EL2444C still have 1V of output swing.

Gain-Bandwidth Product and the-3dB Bandwidth

The EL2244C/EL2444C have a gain-bandwidth product of 120 MHz while using only 5.2mA of supply current per amplifier. For gains greater than 4, their closed-loop -3 dB bandwidth is approximately equal to the gain-

EL2244C, EL2444C

Dual/Quad Low-Power 120MHz Unity-Gain Stable Op Amp

bandwidth product divided by the noise gain of the circuit. For gains less than 4, higher-order poles in the amplifiers' transfer function contribute to even higher closed loop bandwidths. For example, the EL2244C/EL2444C have a -3dB bandwidth of 120MHz at a gain of +1, dropping to 60MHz at a gain of +2. It is important to note that the EL2244C/EL2444C have been designed so that this "extra" bandwidth in low-gain applications does not come at the expense of stability. As seen in the typical performance curves, the EL2244C/EL2444C in a gain of +1 only exhibit 1.0dB of peaking with a 1000 Ω load.

Video Performance

An industry-standard method of measuring the video distortion of components such as the EL2244C/EL2444C is to measure the amount of differential gain (dG) and differential phase (dP) that they introduce. To make these measurements, a 0.286V_{pp} (40 IRE) signal is applied to the device with 0V DC offset (0 IRE) at either 3.58MHz for NTSC or 4.43MHz for PAL. A second measurement is then made at 0.714V DC offset (100 IRE). Differential gain is a measure of the change in amplitude of the sine wave, and is measured in percent. Differential phase is a measure of the change in phase, and is measured in degrees.

For signal transmission and distribution, a back-terminated cable (75 Ω in series at the drive end, and 75 Ω to ground at the receiving end) is preferred since the impedance match at both ends will absorb any reflections. However, when double termination is used, the received signal is halved; therefore a gain of 2 configuration is typically used to compensate for the attenuation.

The EL2244C/EL2444C have been designed as an economical solution for applications requiring low video distortion. They have been thoroughly characterized for video performance in the topology described above, and the results have been included as typical dG and dP specifications and as typical performance curves. In a gain of +2, driving 150 Ω , with standard video test levels at the input, the EL2244C/EL2444C exhibit dG and dP of only 0.04% and 0.15° at NTSC and PAL. Because dG and dP can vary with different DC offsets, the video performance of the EL2244C/EL2444C has been

characterized over the entire DC offset range from -0.714V to +0.714V. For more information, refer to the curves of dG and dP vs DC Input Offset.

Output Drive Capability

The EL2244C/EL2444C have been designed to drive low impedance loads. They can easily drive 6V_{pp} into a 150 Ω load. This high output drive capability makes the EL2244C/EL2444C an ideal choice for RF, IF and video applications. Furthermore, the current drive of the EL2244C/EL2444C remains a minimum of 35 mA at low temperatures. The EL2244C/EL2444C are current-limited at the output, allowing it to withstand shorts to ground. However, power dissipation with the output shorted can be in excess of the power-dissipation capabilities of the package.

Capacitive Loads

For ease of use, the EL2244C/EL2444C have been designed to drive any capacitive load. However, the EL2244C/EL2444C remain stable by automatically reducing their gain-bandwidth product as capacitive load increases. Therefore, for maximum bandwidth, capacitive loads should be reduced as much as possible or isolated via a series output resistor (R_s). Similarly, coax lines can be driven, but best AC performance is obtained when they are terminated with their characteristic impedance so that the capacitance of the coaxial cable will not add to the capacitive load seen by the amplifier. Although stable with all capacitive loads, some peaking still occurs as load capacitance increases. A series resistor at the output of the EL2244C/EL2444C can be used to reduce this peaking and further improve stability.

Printed-Circuit Layout

The EL2244C/EL2444C are well behaved, and easy to apply in most applications. However, a few simple techniques will help assure rapid, high quality results. As with any high-frequency device, good PCB layout is necessary for optimum performance. Ground-plane construction is highly recommended, as is good power supply bypassing. A 0.1 μ F ceramic capacitor is recommended for bypassing both supplies. Lead lengths should be as short as possible, and bypass capacitors should be as close to the device pins as possible. For

EL2244C, EL2444C***Dual/Quad Low-Power 120MHz Unity-Gain Stable Op Amp***

good AC performance, parasitic capacitances should be kept to a minimum at both inputs and at the output. Resistor values should be kept under 5 k Ω because of the RC time constants associated with the parasitic capacitance. Metal-film and carbon resistors are both acceptable, use of wire-wound resistors is not recommended because of their parasitic inductance. Similarly, capacitors should be low-inductance for best performance.

The EL2244C/EL2444C Macromodel

This macromodel has been developed to assist the user in simulating the EL2244C/EL2444C with surrounding circuitry. It has been developed for the PSPICE simulator (copywritten by the Microsim Corporation), and may need to be rearranged for other simulators. It approximates DC, AC, and transient response for resistive loads, but does not accurately model capacitive loading. This model is slightly more complicated than the models used for low-frequency op-amps, but it is much more accurate for AC analysis.

The model does not simulate these characteristics accurately:

| | |
|---------------|--------------------------|
| noise | non-linearities |
| settling-time | temperature effects |
| CMRR | manufacturing variations |
| PSRR | |

EL2244C, EL2444C

Dual/Quad Low-Power 120MHz Unity-Gain Stable Op Amp

EL2244C, EL2444C

EL2244C/EL2444 Macromodel

```
* Connections: +input
*              |
*              | -input
*              | |
*              | | +Vsupply
*              | | |
*              | | | -Vsupply
*              | | | |
*              | | | | output
*              | | | | |
.subckt M2244 3 2 7 4 6
*
* Input stage
*
ie 7 37 1mA
r6 36 37 800
r7 38 37 800
rc1 4 30 850
rc2 4 39 850
q1 30 3 36 qp
q2 39 2 38 qpa
ediff 33 0 39 30 1.0
rdiff 33 0 1Meg
*
* Compensation Section
*
ga 0 34 33 0 1m
rh 34 0 2Meg
ch 34 0 1.3pF
rc 34 40 1K
cc 40 0 1pF
*
* Poles
*
ep 41 0 40 0 1
rpa 41 42 200
cpa 42 0 1pF
rpb 42 43 200
cpb 43 0 1pF
*
* Output Stage
*
ios1 7 50 1.0mA
ios2 51 4 1.0mA
q3 4 43 50 qp
q4 7 43 51 qn
q5 7 50 52 qn
q6 4 51 53 qp
ros1 52 6 25
ros2 6 53 25
*
* Power Supply Current
*
ips 7 4 2.7mA
*
* Models
*
.model qn npn(is=800E-18 bf=200 tf=0.2nS)
.model qpa pnp(is=864E-18 bf=100 tf=0.2nS)
.model qp pnp(is=800E-18 bf=125 tf=0.2nS)
.ends
```

EL2244C, EL2444C

Dual/Quad Low-Power 120MHz Unity-Gain Stable Op Amp

EL2244C/EL2444C Macromodel

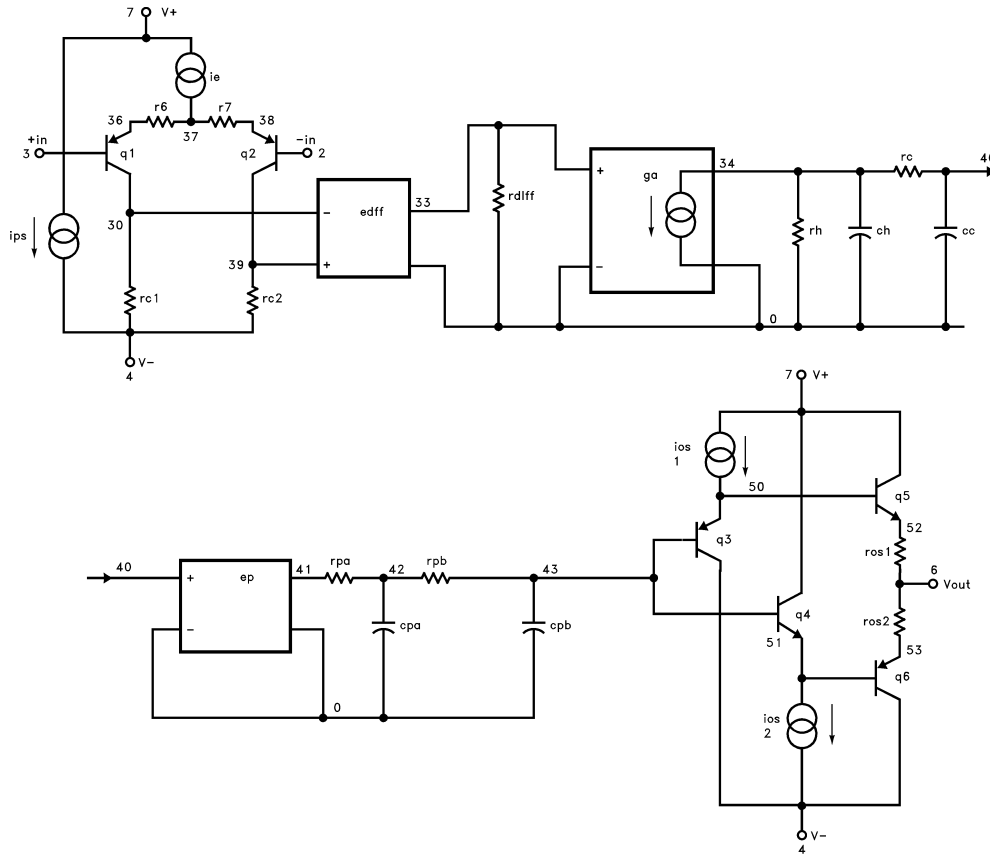

EL2244C/EL2444C Model

EL2244C, EL2444C

Dual/Quad Low-Power 120MHz Unity-Gain Stable Op Amp

EL2244C, EL2444C

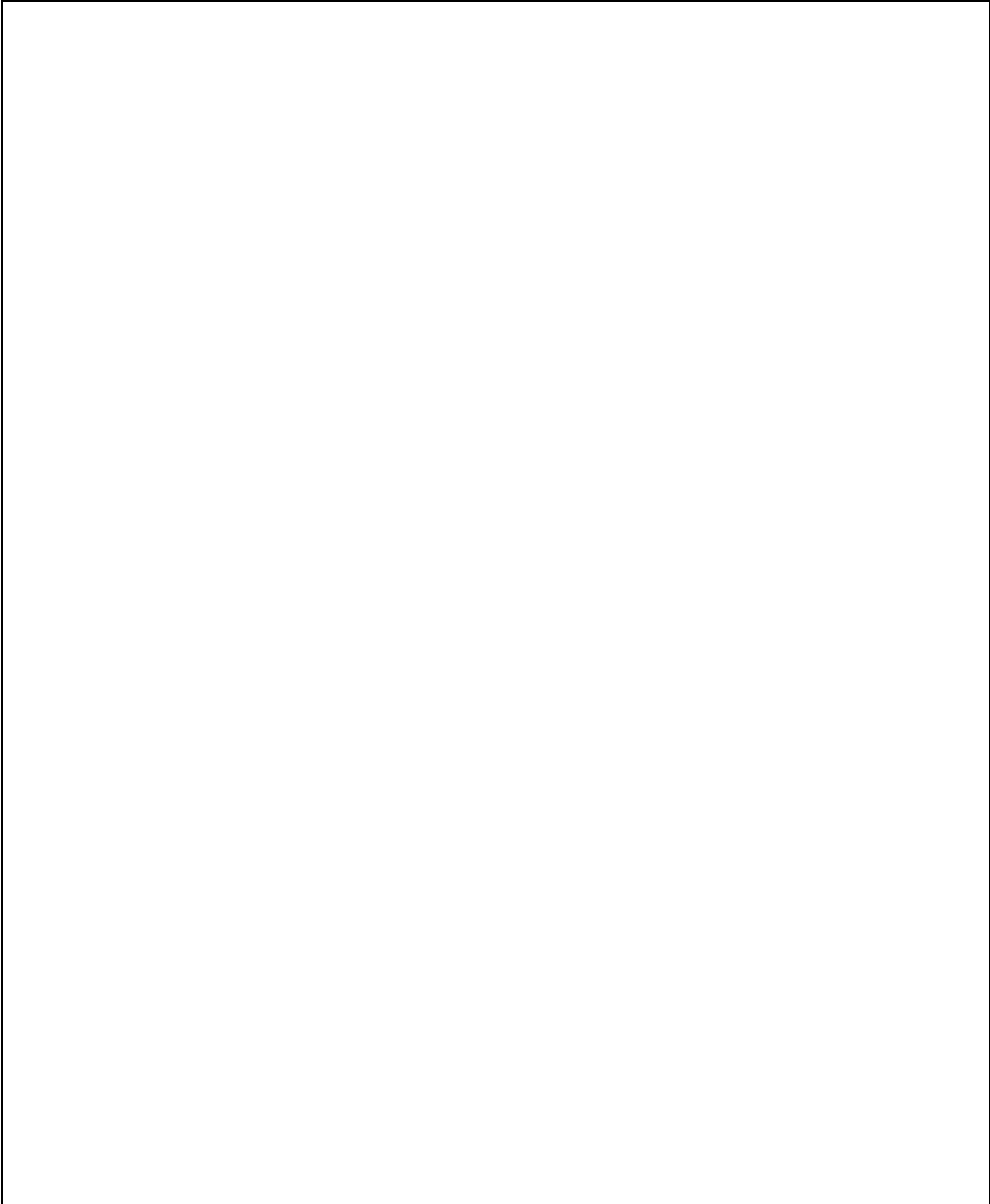

EL2244C, EL2444C*Dual/Quad Low-Power 120MHz Unity-Gain Stable Op Amp***General Disclaimer**

Specifications contained in this data sheet are in effect as of the publication date shown. Elantec, Inc. reserves the right to make changes in the circuitry or specifications contained herein at any time without notice. Elantec, Inc. assumes no responsibility for the use of any circuits described herein and makes no representations that they are free from patent infringement.

élantec

HIGH PERFORMANCE ANALOG INTEGRATED CIRCUITS

Elantec Semiconductor, Inc.

675 Trade Zone Blvd.

Milpitas, CA 95035

Telephone: (408) 945-1323

(888) ELANTEC

Fax: (408) 945-9305

European Office: +44-118-977-6020

Japan Technical Center: +81-45-682-5820

WARNING - Life Support Policy

Elantec, Inc. products are not authorized for and should not be used within Life Support Systems without the specific written consent of Elantec, Inc. Life Support systems are equipment intended to support or sustain life and whose failure to perform when properly used in accordance with instructions provided can be reasonably expected to result in significant personal injury or death. Users contemplating application of Elantec, Inc. Products in Life Support Systems are requested to contact Elantec, Inc. factory headquarters to establish suitable terms & conditions for these applications. Elantec, Inc.'s warranty is limited to replacement of defective components and does not cover injury to persons or property or other consequential damages.