



HP SunPower Series

- HPWA-MH00 HPWT-RH00
- HPWA-DH00 HPWT-MH00
- HPWA-ML00 HPWT-DH00
- HPWA-DL00 HPWT-BH00
- HPWT-RD00 HPWT-RL00
- HPWT-MD00 HPWT-ML00
- HPWT-DD00 HPWT-DL00
- HPWT-BD00 HPWT-BL00

Super Flux LEDs

Technical Data

Benefits

- Fewer LEDs Required
- Lowers Lighting System Cost

Features

- High Flux Output
- Designed for High Current Operation
- Low Thermal Resistance
- Low Profile
- Meets SAE/ECE/JIS Automotive Color Requirements
- Packaged in Tubes for Use with Automatic Insertion Equipment

Applications

- Automotive Exterior Lighting
- Electronic Signs and Signals

Description

This revolutionary package design allows the lighting designer to reduce the number of LEDs required and provide a more uniform and unique illuminated appearance than with other LED solutions. This is possible through the efficient optical package design and high-current capabilities.



The low profile package can be easily coupled with reflectors or lenses to efficiently distribute light and provide the desired lit appearance.

Device Selection Guide

Part Number	LED Color	Total Flux θ_v (mlm) @ 70 mA ^[1] Typ.	Total Included Angle $\theta_{0.90v}$ (Degrees) ^[2] Typ.
HPWA-MH00-00000	AS AlInGaP Red-Orange	1500	95
HPWA-DH00-00000			75
HPWA-ML00-00000	AS AlInGaP Amber	750	95
HPWA-DL00-00000			75
HPWT-RD00-00000	TS AlInGaP Red	3000	44 x 88
HPWT-MD00-00000			100
HPWT-DD00-00000			70
HPWT-BD00-00000			50
HPWT-RH00-00000	TS AlInGaP Red-Orange	3750	44 x 88
HPWT-MH00-00000			100
HPWT-DH00-00000			70
HPWT-BH00-00000			50
HPWT-RL00-00000	TS AlInGaP Amber	1500	44 x 88
HPWT-ML00-00000			100
HPWT-DL00-00000			70
HPWT-BL00-00000			50

Notes: 1. θ_v is the total luminous flux output as measured with an integrating sphere after the device has stabilized ($R\theta_{j-a} = 200^\circ\text{C/W}$, $T_A = 25^\circ\text{C}$).
 2. $\theta_{0.90v}$ is the included angle at which 90% of the total luminous flux is captured.

This product family employs the world's brightest red-orange and amber LED materials, which

allow designers to match the color of popular lighting applications, such as automotive

tail, stop, and turn signal lamps, and electronic signs.

Outline Drawing

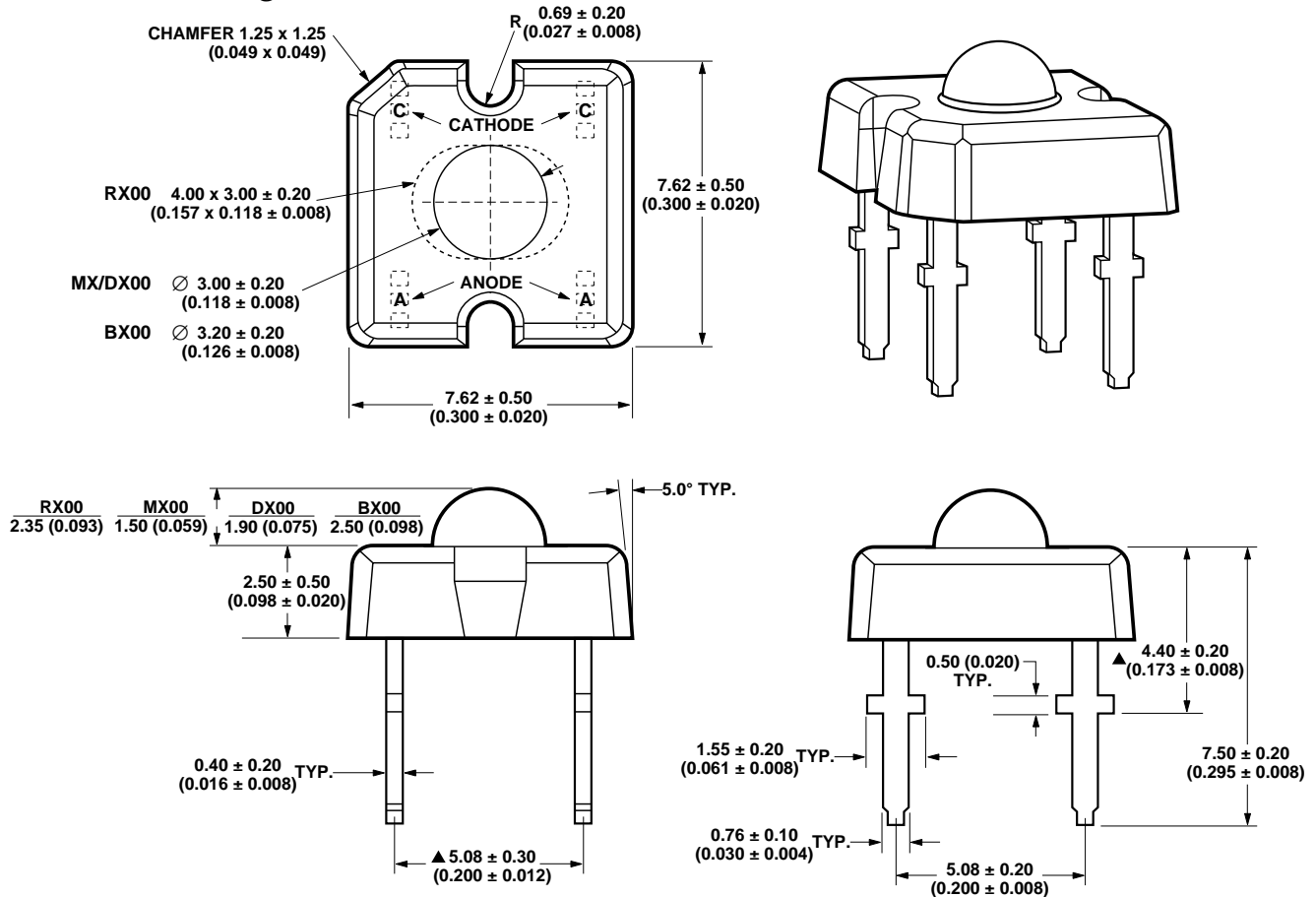

- NOTES: 1. DIMENSIONS ARE IN MILLIMETERS (INCHES).
 2. DIMENSIONS WITHOUT TOLERANCES ARE NOMINAL.
 3. CATHODE LEADS ARE INDICATED WITH A "C" AND ANODE LEADS ARE INDICATED WITH AN "A".
 4. ▲ DENOTES SPECIAL CHARACTERISTIC.

Absolute Maximum Ratings at $T_A = 25^\circ\text{C}$

Parameter	HPWA-XX00	HPWT-XX00	Units
DC Forward Current ^[1,2]	70	70	mA
Power Dissipation	187	221	mW
Reverse Voltage ($I_R = 100 \mu\text{A}$)	10	10	V
Operating Temperature Range	-40 to +100	-40 to +100	°C
Storage Temperature	-55 to +100	-55 to +100	°C
High Temperature Chamber	125°C, 2 hrs.		
LED Junction Temperature	125°C		
Solder Conditions ^[3]			
Preheat Temperature	100°C for 30 seconds		
Solder Temperature	260°C for 5 seconds [1.5 mm (0.06 in.) below seating plane]		

Notes:

- Derate linearly as shown in Figures 4a and 4b.
- Operation at currents below 10 mA is not recommended, please contact your Hewlett-Packard sales representative.
- Detailed wave soldering instructions are available in Application Note 1149-2.

Optical Characteristics at $T_A = 25^\circ\text{C}$, $I_F = 70\text{ mA}$, $R_{\theta\text{J-A}} = 200^\circ\text{C/W}$

Device Type	Total Flux Φ_v (mIm) ^[1]		Peak Wavelength λ_{peak} (nm) Typ.	Color, Dominant Wavelength λ_d (nm) ^[2] Typ.	Total Included Angle $\theta_{0.90\text{V}}$ (Degrees) ^[3] Typ.	Luminous Intensity/ Total Flux I_v (mcd)/ Φ_v (mIm) Typ.	Viewing Angle $2\theta_{1/2}$ (Degrees) Typ.
	Min.	Typ.					
HPWA-MH00	600	1500	624	618	95	0.6	90
HPWA-DH00							
HPWA-ML00	600	750	594	592	95	0.6	90
HPWA-DL00							
HPWT-RD00	1000	3000	640	630	44 x 88	1.25	25 x 68
HPWT-MD00					100	0.6	70
HPWT-DD00					70	1.5	40
HPWT-BD00					50	2.0	30
HPWT-RH00	1000	3750	626	620	44 x 88	1.25	25 x 68
HPWT-MH00					100	0.6	70
HPWT-DH00					70	1.5	40
HPWT-BH00					50	2.0	30
HPWT-RL00	1000	1500	596	594	44 x 88	1.25	25 x 68
HPWT-ML00					100	0.6	70
HPWT-DL00					70	1.5	40
HPWT-BL00					50	2.0	30

Notes:

- Φ_v is the total luminous flux output as measured with an integrating sphere after the device has stabilized.
- The dominant wavelength is derived from the CIE Chromaticity Diagram and represents the perceived color of the device.
- $\theta_{0.90\text{V}}$ is the included angle at which 90% of the total luminous flux is captured.

Electrical Characteristics at $T_A = 25^\circ\text{C}$

Device Type	Forward Voltage V_F (Volts) @ $I_F = 70\text{ mA}$			Reverse Breakdown V_R (Volts) @ $I_R = 100\text{ }\mu\text{A}$		Capacitance C (pF) $V_F = 0$, $f = 1\text{ MHz}$ Typ.	Thermal Resistance $R_{\theta\text{J-PIN}}$ ($^\circ\text{C/W}$) Typ.	Speed of Response τ_s (ns) ^[1] Typ.
	Min.	Typ.	Max.	Min.	Typ.			
HPWA-XH00	1.83	2.1	2.67	10	20	40	155	20
HPWA-XL00	1.83	2.2	2.67	10	20	40	155	20
HPWT-XD00	2.15	2.5	3.03	10	20	40	125	20
HPWT-XH00	2.15	2.5	3.03	10	20	40	125	20
HPWT-XL00	2.15	2.6	3.15	10	20	40	125	20

Note:

- τ_s is the time constant, e^{-t/τ_s} .

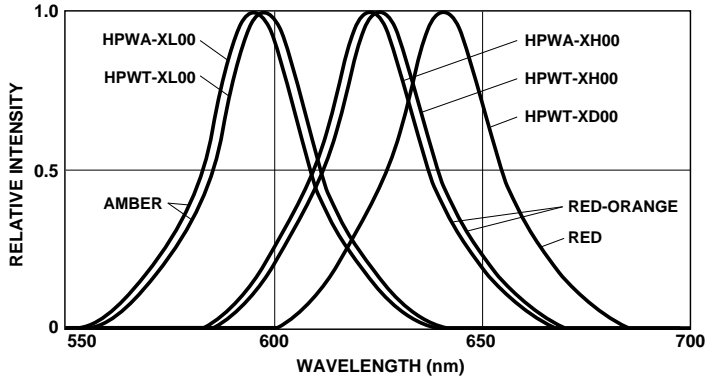

Figure 1. Relative Intensity vs. Wavelength.

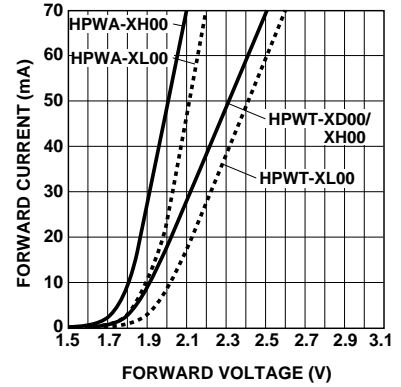

Figure 2. Forward Current vs. Forward Voltage.

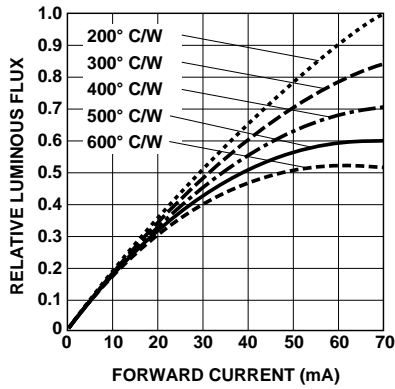

Figure 3. HPWA/HPWT-XX00 Relative Luminous Flux vs. Forward Current.

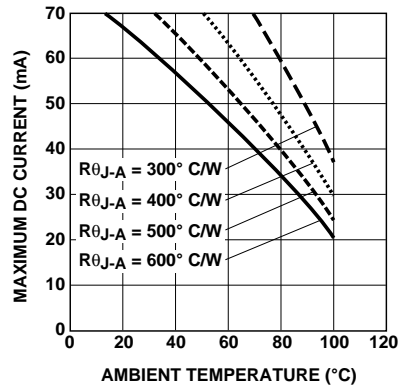

Figure 4a. HPWA-XX00 Maximum DC Forward Current vs. Ambient Temperature.

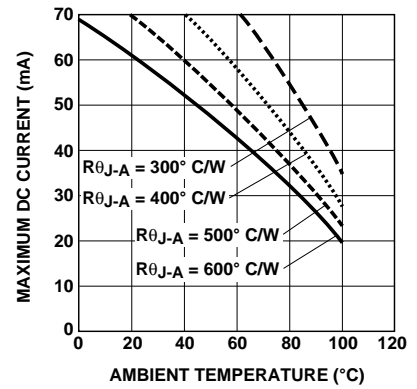

Figure 4b. HPWT-XX00 Maximum DC Forward Current vs. Ambient Temperature.

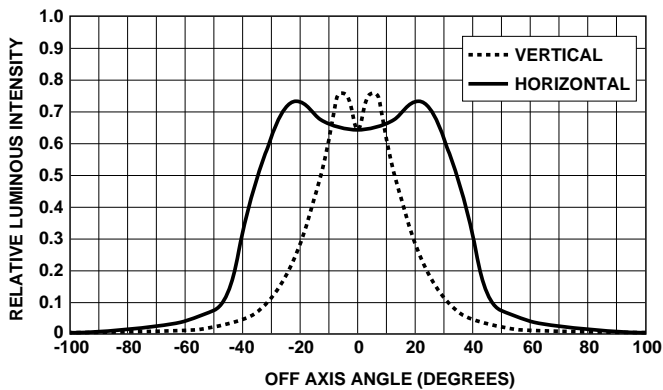

Figure 5a. HPWT-RX00 Relative Luminous Intensity vs. Off Axis Angle.

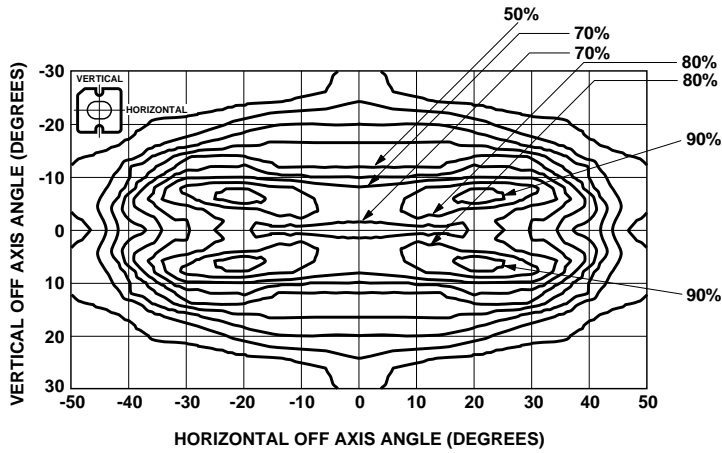

Figure 5b. HPWT-RX00 Relative Luminous Intensity vs. Off Axis Angle. Iso-Intensity Contour Plot.

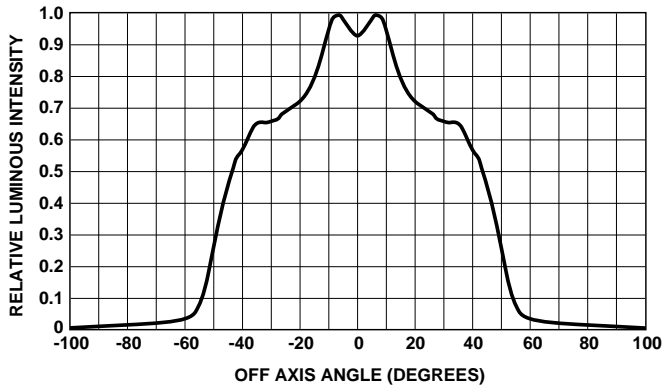

Figure 5c. HPWA-MX00 Relative Luminous Intensity vs. Off Axis Angle.

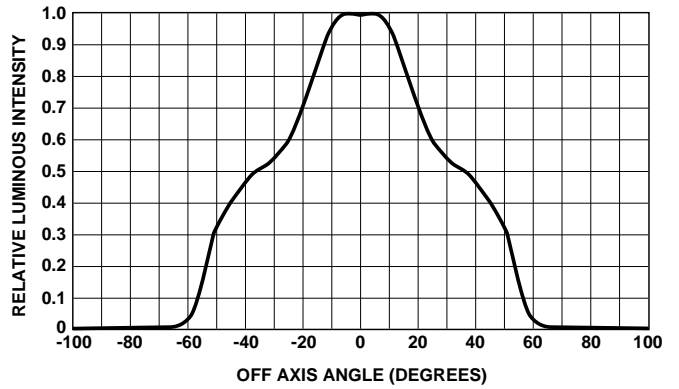

Figure 5d. HPWT-MX00 Relative Luminous Intensity vs. Off Axis Angle.

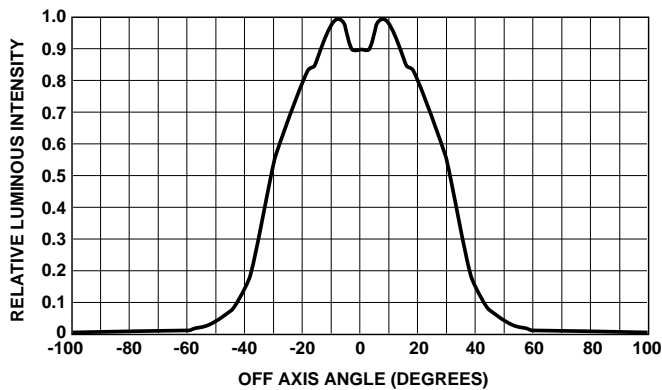

Figure 5e. HPWA-DX00 Relative Luminous Intensity vs. Off Axis Angle.

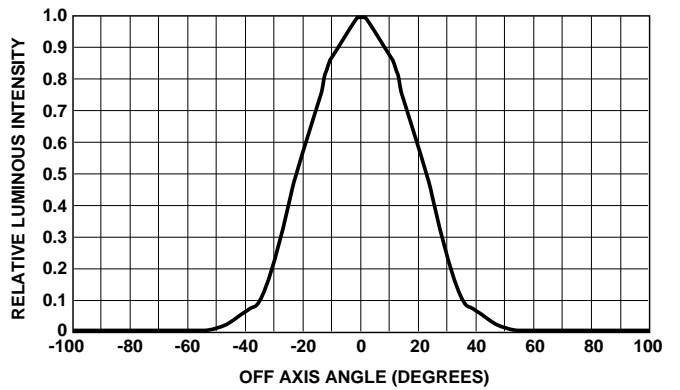

Figure 5f. HPWT-DX00 Relative Luminous Intensity vs. Off Axis Angle.

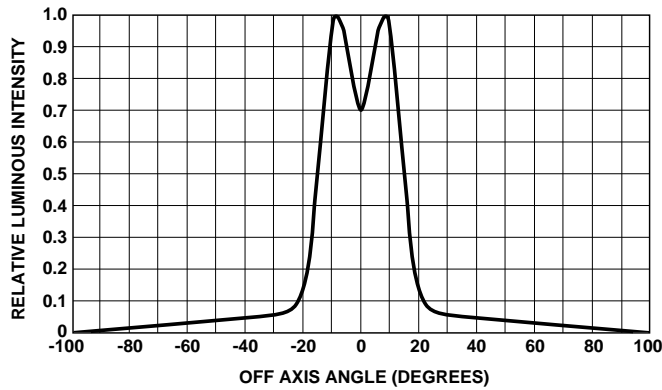

Figure 5g. HPWT-BX00 Relative Luminous Intensity vs. Off Axis Angle.

For additional information about Super Flux LEDs, please refer to HP Application Note 1149. Copies of the application brief can be obtained from your local field sales engineer. You may also visit the HP web site at "www.hp.com./go/automotive".

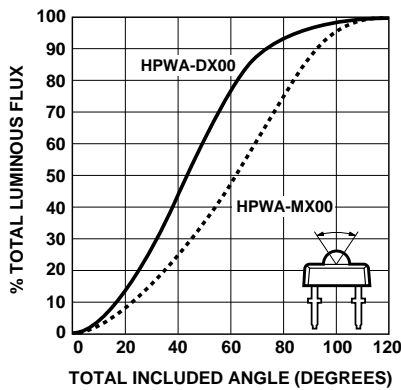

Figure 6a. HPWA-XX00 Percent Total Luminous Flux vs. Total Included Angle.

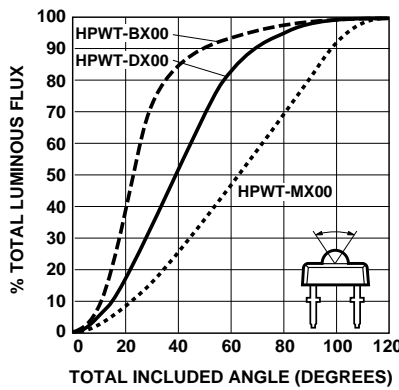

Figure 6b. HPWT-XX00 Percent Total Luminous Flux vs. Total Included Angle.

www.hp.com/go/led

For technical assistance or the location of your nearest Hewlett-Packard sales office, distributor or representative call:

Americas/Canada: 1-800-235-0312 or 408-654-8675

Far East/Australasia: Call your local HP sales office.

Japan: (81 3) 3335-8152

Europe: Call your local HP sales office.

Data subject to change.

Copyright © 1998 Hewlett-Packard Co.

Obsoletes 5968-1098E (8/98)

5968-3379E (12/98)