

TOSHIBA CMOS Digital Integrated Circuit Silicon Monolithic

TC83230-0025/JTC83230-0025S

TC83230-0025/JTC83230-0025S: Single-Chip CMOS LSI for Calculators with Printers
(applicable printer heads: PTMFL 63 manufactured by ALPS)

The TC83230-0025, JTC83230-0025S LSI is a single-chip CMOS LSI for use in calculators with printers.

It integrates I/O logic circuits necessary to configure a calculator with 10-digit display, two memory functions and TWO TAX functions, serial printer used to print calculation results, oscillator, and LCD drivers.

Features

Operational Features

- Print: 11 digits of data. (including decimal point.) 1 digit of minus sign, 2 digits of operational symbol.
1-color printing (black).
- Display: 10 digits of data. (including punctuation in each digit.) 1 digit of floating minus sign, memory I, II load, error symbol, grand total memory load, 3 digits of commas.
- Decimal output: Decimal set lock key controls output format. Fixed decimal setting ("0", "1", "2", "3", "4", "6"), full floating point, and ADD/ADDII mode.
- Key-input buffer: 12 words
- Operation methods: Algebraic operation
- Function: Four arithmetic functions, repeat multiplication and division, mixed calculation, square root calculation, percentage calculation, percent discount and add-on calculations, memory calculation, add-mode calculation, mark-up/down calculation, total calculation, constant calculation, tax calculation.
Two-key rollover
- Leading zero suppression

Protection

- (1) In the overflow condition, all keys except "C", "C/CE", "CE", "→" key are inoperative.
- (2) Key chatter protection.

Auto-Clear at Power On

Auto-clear functions by connecting a capacitor to the RESET pin.

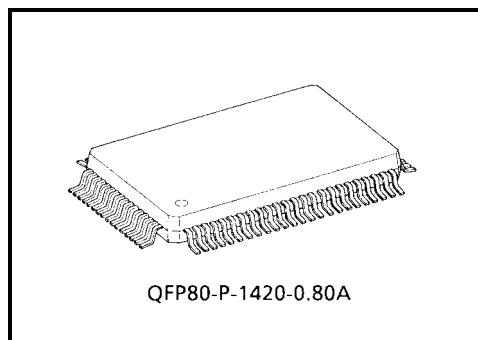

Weight: 1.52 g (typ.)

Pin Assignment (top view)

QFP80

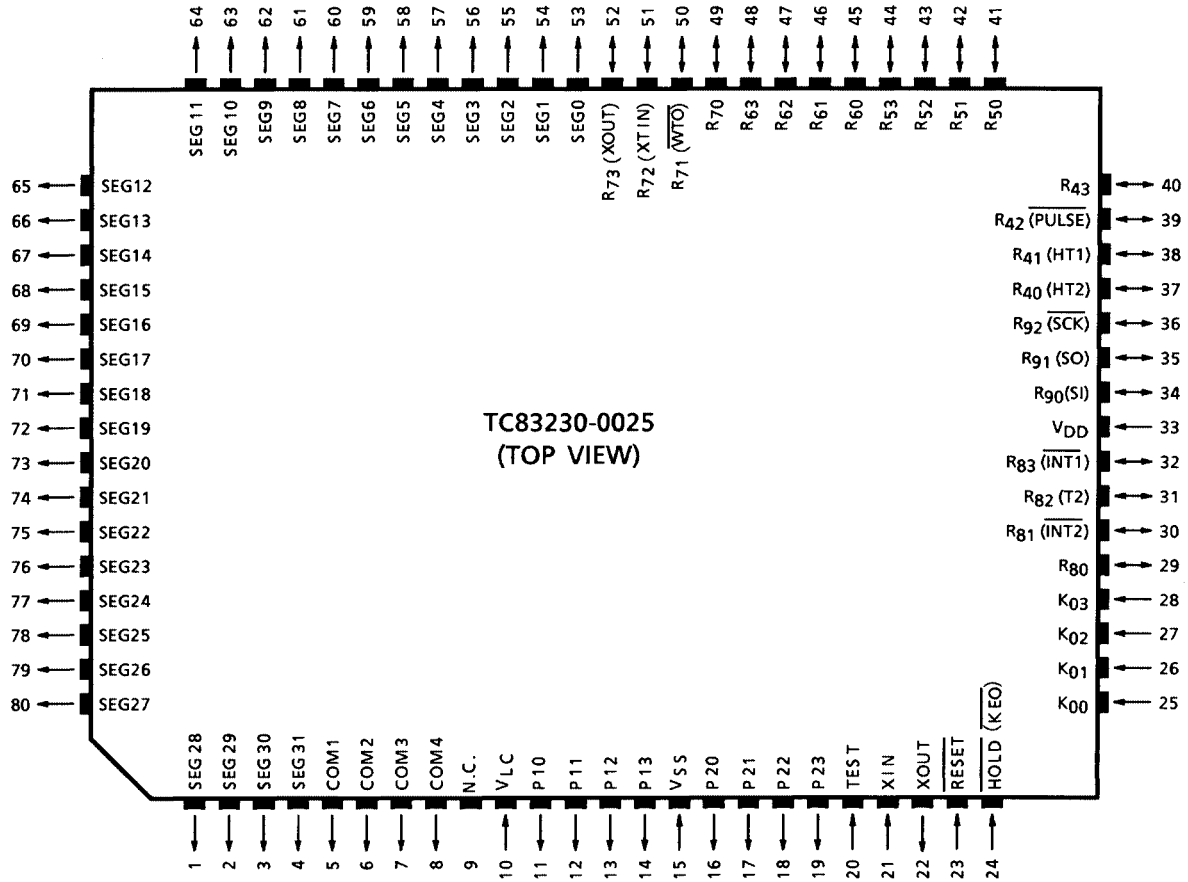

System Block Diagram

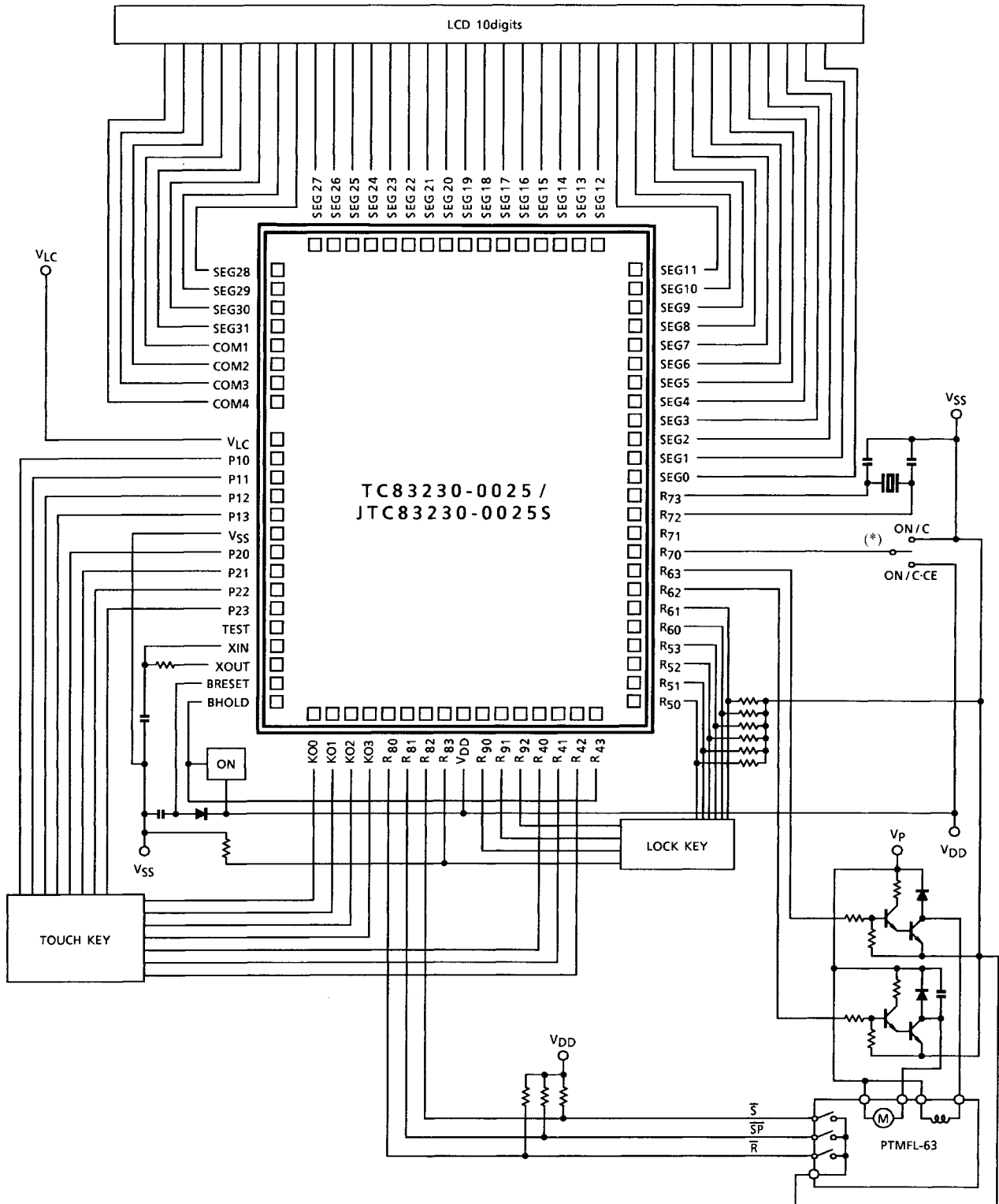

Note 1: (*) is ON key function selectable switch.

Connection of LCD

Segment

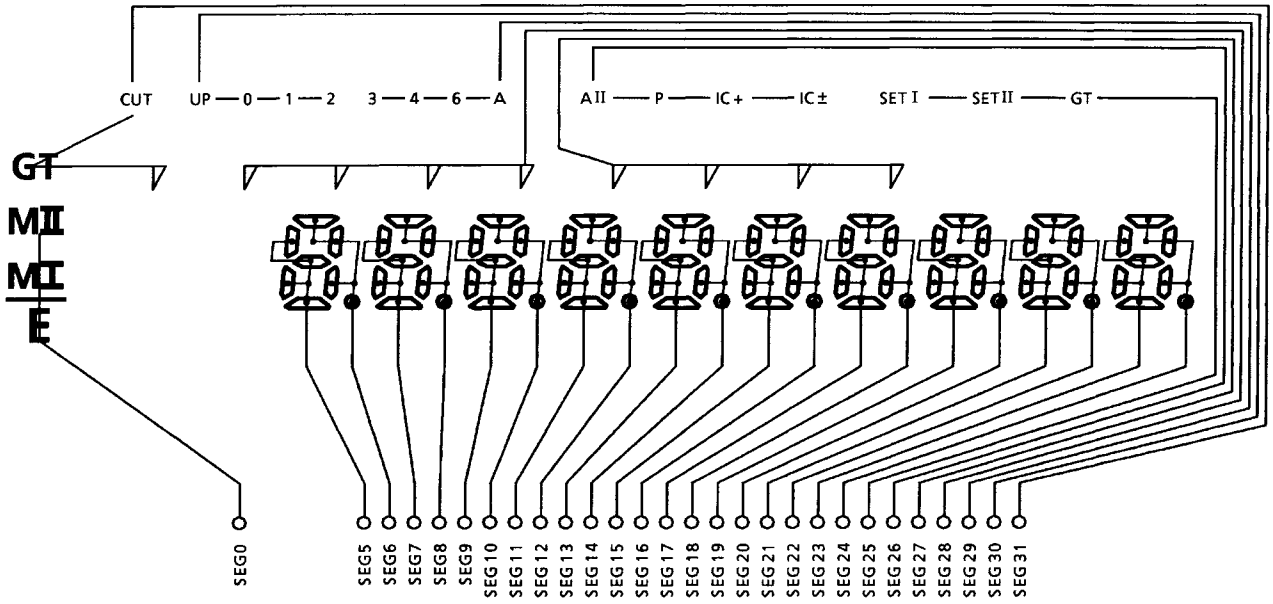

Common

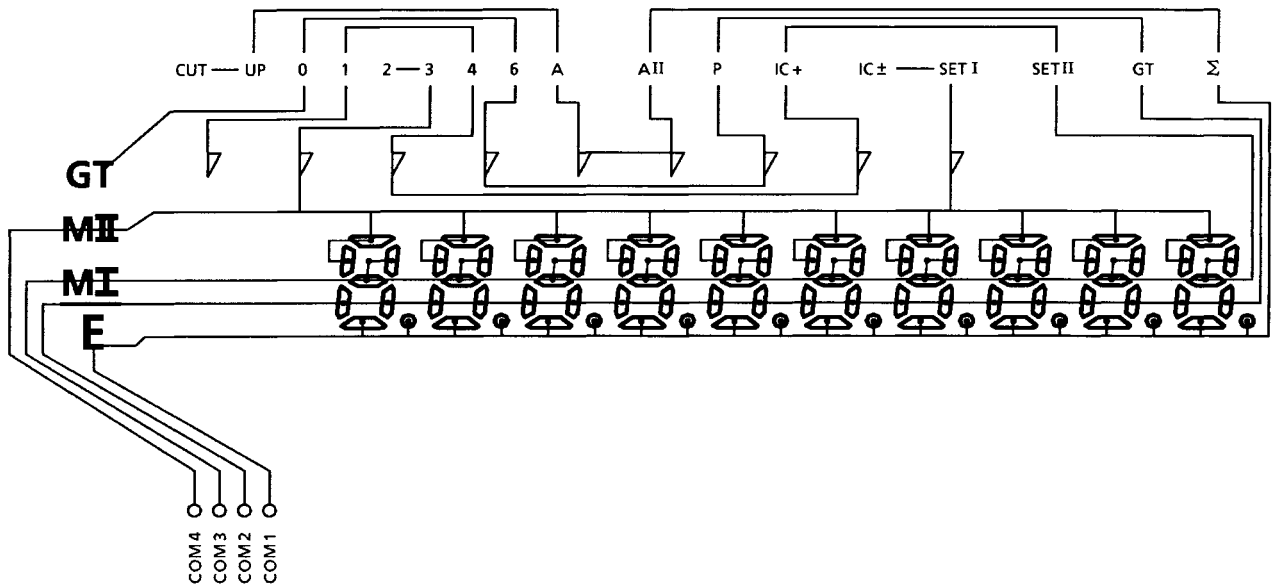

Key Connection

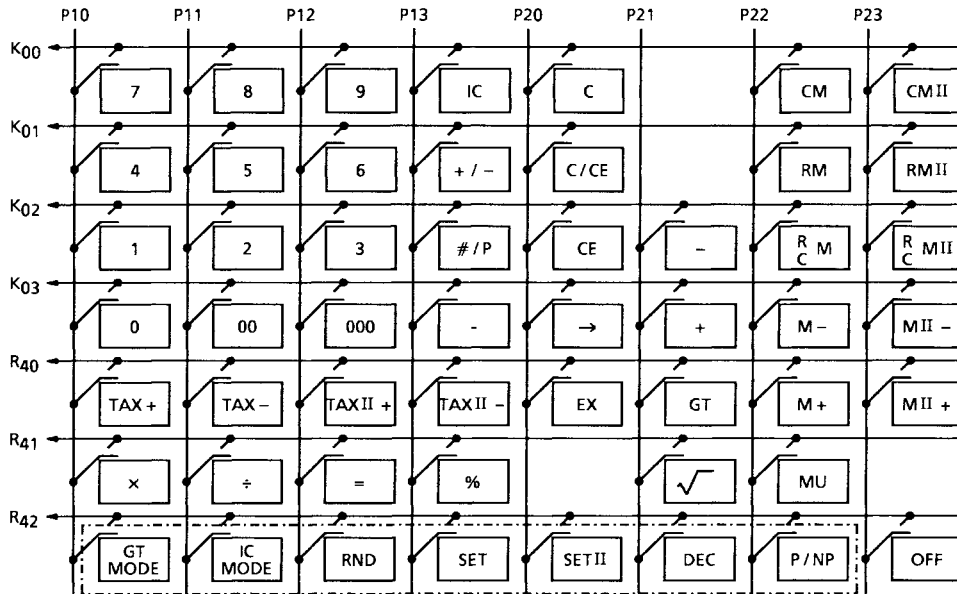

Touch Key

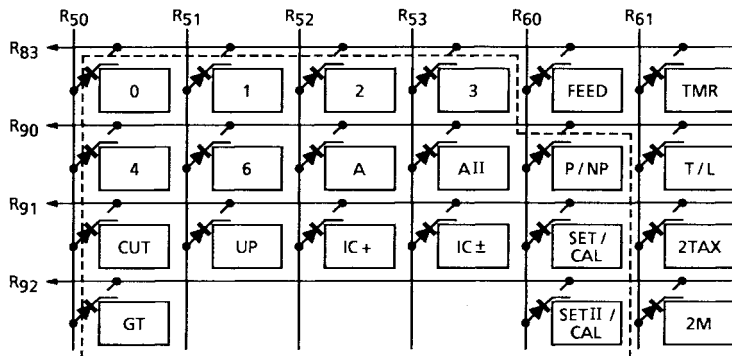

Lock Key

Touch Key

Lock Key

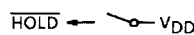
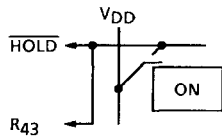

ON Key

Note 2: The T/L key selects either touch key mode or lock key mode.

Note 3: When the T/L key is open, lock key mode is used. In lock key mode, the touch keys within the dotted area cannot be used.

Note 4: When the T/L key is connected, touch key mode is used. In touch key mode, the lock keys within the dotted area cannot be used.

Specification of Calculator

Operation Specifications

(1) Operations depending on key types and modes

- Touch key

Key Name	CAL Mode		Tax Set Mode (SETI/II key is on)		
	Mode Switch	Touch Key Mode	Touch Key Mode	Lock Key Mode	
C		Operates as clear key	Operates as clear key	Operates as clear key	Operates as clear key
CE		Operates as clear entry key	Operates as clear entry key	Operates as clear entry key	Operates as clear entry key
C/CE		Operates as clear or clear entry key	Operates as clear or clear entry key	Operates as clear or clear entry key	Operates as clear or clear entry key
Numeral		Numeral Key-inputs numerals	Numeral Key-inputs numerals	Numeral Key-inputs numerals	Numeral Key-inputs numerals
OFF		Operates as off key	—	Unused	Unused
.		Key-inputs decimal points	Key-inputs decimal points	Key-inputs decimal points	Key-inputs decimal points
+ , - × , ÷		Operates as four-function key	Operates as four-function key	Unused	Unused
=		Operates as = key	Operates as = key	Unused	Unused
P/NP		Switches print or non-print	—	Unused	Unused
RND		Switches round-off and round-up	—	Unused	Unused
DEC		Switches decimal points	—	Unused	Unused
%		Operates as % key	Operates as % key	Unused	Unused
MU/D		Operates as mark-up/down key	Operates as mark-up/down key	Unused	Unused
IC		Operates as item count key	Operates as item count key	Unused	Unused
#/P		Operates as non-add-print key for left-justified printing	Operates as non-add-print key for left-justified printing	Unused	Unused
→		Operates as right-shift key	Operates as right-shift key	Operates as right-shift key	Operates as right-shift key
+/-		Operates as sign change key	Operates as sign change key	Unused	Unused
MIC, MIIC MIR, MIIR, MI-, MII-, MI+, MII+		Operates as memory function key	Operates as memory function key	Unused	Unused
-TAXI/II		Operates as -TAXI/II key	Operates as -TAXI/II key	Unused	Unused
+TAXI/II		Operates as +TAXI/II key	Operates as +TAXI/II key	Unused	Unused
IC MOD		Operates as IC-mode key	—	Unused	Unused
GT MOD		Operates as GT-mode or non-GT mode key	—	Unused	Unused
GT		Operates as GT key	Operates as GT key	Unused	Unused
EXC		Operates as EXC key	Operates as EXC key	Unused	Unused
$\sqrt{\quad}$		Operates as $\sqrt{\quad}$ key	Operates as $\sqrt{\quad}$ key	Unused	Unused

- Lock key

Key Name Mode Switch	CAL Mode		Tax Set Mode (SET I/II key is on)	
	Touch Key Mode	Lock Key Mode	Touch Key Mode	Lock Key Mode
0, 1, 2, 3, 4, 6, A, All	—	Switches decimal points	Unused	Unused
CUT, UP	—	Switches round-off and round-up	Unused	Unused
IC±, IC+	—	Operates as IC±/IC+ key	Unused	Unused
GT	—	Switches GT-mode or non-GT mode	Unused	Unused
FEED	Operates as paper feed key	Operates as paper feed key	Operates as paper feed key	Operates as paper feed key
P/NP	—	Switches print or non-print	Unused	Unused
\bar{T}/L (Note 5)	Selects lock key mode or touch key mode.			
2 TAX (Note 5)	Selects single tax mode or double tax mode.			
2 M (Note 5)	Selects single memory mode or double memory mode.			

Note 5: Can switch modes only with the reset key.

(2) Explanation of touch keys

[0] to [9], [00], [000]

- Pressing these keys enters numerals.
- Pressing these keys other than during numeral entry clears the display and displays the entered numeral in the first digit.
- An entered value which exceeds 10 display digits is invalid.

[.]

- Pressing this key enters a decimal point.
- Pressing this key other than during numeral entry displays “0.” and retains the decimal point position. Every time a numeral is entered, the position of the decimal point is shifted.
- If this key is pressed twice or more during numeral entry, the decimal point at the second and subsequent presses is not displayed.

[+/-]

- Pressing this key displays the opposite sign.
- Pressing this key following the [+], [-], [×], or [÷] key is invalid.

[→]

- During numeral entry, pressing this key shifts the entered numeral (s) to the right (the rightmost numeral is deleted). A decimal point on the rightmost numeral is deleted together with the numeral.
- Pressing this key during an entry such as [MR] is valid in the same way as during numeral entry.
- Pressing the key following the [+], [-], [×], or [÷] key is invalid. It is also invalid after the operation is complete.
- Pressing the key when there is a rough estimation error cancels the error, leaving the erroneous value displayed.

[C]

- Pressing this key clears registers of the operation result or during operation. It also cancels operation instructions and errors. Prints "0.*" and feeds paper one line.
- The key does not clear the memory registers, GT register, or TAX registers. Clears the item counter.

[CE]

- Pressing this key clears the entered numeral value during numeral entry but retains the operation instruction and operand register contents.
- Pressing the key when there is a rough estimation error cancels the error, leaving the erroneous value displayed. In cases other than the above, the key is invalid.

[C/CE]

- This key functions as the [CE] key during numeral entry or rough estimation error. If the key is pressed twice or more, it functions as the [C] key.
- In cases other than the above, the key functions as the [C] key.

[+]

- Pressing this key retains addition as the operation.
- Pressing the key following the operand (the first entered numeral) prints the entered value with the + symbol.
- Pressing the key following the [+], [-], [×], or [÷] key prints only the + symbol, not the numeric value. Switches the operation to addition.
- Pressing the key following the operator (the second entered numeral) prints the entered value with the + symbol, executes the calculation retained at that time, and displays the result. The result value is displayed with a floating point representation regardless of the TAB specification.
- Increments the item counter.

[-]

- Pressing this key retains subtraction as the operation.
- Pressing the key following the operand (the first entered numeral) prints the entered value with the – symbol.
- Pressing the key following the [+], [-], [×], or [÷] key prints only the – symbol, not the numeric value. Switches the operation to addition.
- Pressing the key following the operator (the second entered numeral) prints the entered value with the – symbol, executes the calculation retained at that time, and displays the result. The result value is displayed with a floating point representation regardless of the TAB specification.
- Increments/decrements the item counter.

[×]

- Pressing this key retains multiplication as the operation.
- Pressing the key following the operand (the first entered numeral) prints the entered value with the × symbol.
- Pressing the key following the [+], [-], [×], or [÷] key prints only the × symbol, not the numeric value. Switches the operation to addition.
- Pressing the key following the operator (the second entered numeral) prints the entered value with the × symbol, executes the calculation retained at that time, and displays the result. The result value is displayed with a floating point representation regardless of the TAB specification.

[÷]

- Pressing this key retains division as the operation.
- Pressing the key following the operand (the first entered numeral) prints the entered value with the ÷ symbol.
- Pressing the key following the [+], [-], [×], or [÷] key prints only the ÷ symbol, not the numeric value. Switches the operation to addition.
- Pressing the key following the operator (the second entered numeral) prints the entered value with the ÷ symbol, executes the calculation retained at that time, and displays the result. The result value is displayed with a floating point representation regardless of the TAB specification.

[=]

- Unless addition, subtraction, multiplication or division is retained, this key is invalid.
- Pressing the key prints the displayed value with the = symbol.
- After performing the retained operation (addition, subtraction, multiplication, or division), rounds the calculation result according to the TAB specification, prints the result with the * symbol, and feeds the paper one line.
- Retains the operand for multiplication; the operator for addition, subtraction, and division, together with constant mode.
- Pressing the key following the [+] or [-] key does not perform the operation but prints the = symbol only, prints the * symbol with the displayed value, and feeds the paper one line.
- If GT mode is specified, adds the value printed with the * symbol to the GT register.

[%]

- Unless addition, subtraction, multiplication or division is retained, this key is invalid.
- Prints the displayed value with the % symbol.
- After performing the % operation on the retained operation, rounds the calculation result according to the TAB specification, prints the result with the * symbol, and feeds the paper one line.
- Retains the operand for multiplication; the operator for addition, subtraction, and division, together with constant mode.
- Pressing the key following the [+] or [-] key does not perform operation. The key is invalid.
- If GT mode is specified, adds the value printed with the * symbol to the GT register.

[#/P]

- Pressing the key following the numeral key prefixes the numeric value with #, performs left-justification, and prints the result.
- Pressing the key following a key other than a numeral key right-justifies the displayed value, and prints it without a symbol.
- Prints even in non-print mode; retains the displayed data and the operation status.

[GT]

- Pressing the key displays/prints the GT register.
- Pressing the key once prints the GT register with the *◇ symbol.
- Consecutively pressing the key twice rounds the GT register according to the TAB specification, prints the result with the ** symbol, feeds the paper one line, and clears the GT register.
- Even if GT mode is not set, the [GT] key is valid.
- The numeric value displayed/printed is processed.

[MU]

- Unless addition, subtraction, multiplication or division is retained, this key is invalid.
- Prints the displayed value with the M% symbol.
- After performing the retained operation, rounds the result according to the TAB specification, prints the result with the * symbol, and feeds the paper one line.
- If multiplication is retained, performs the mark-up operation; constant mode is not set.
- If division is retained, performs the mark-down operation; constant mode is not set.
- If addition or subtraction is retained, performs the change rate operation; constant mode is set.
- Any errors during the above operations are regarded as system errors.

[EX]

- Exchanges the retained constant (typically, the addition, subtraction, multiplication or division constant) with the displayed value, then prints the result with the # symbol.
- Even if the operation (addition, subtraction, multiplication or division) is not retained, the key is valid.

[$\sqrt{\quad}$]

- After printing the displayed value with the $\sqrt{\quad}$ symbol, extracts the square root of the displayed value, rounds the result according to the TAB specification, and prints it with the * symbol.
- For negative calculations, extracts the positive square root, which results in a rough estimation error.
- There is no change in the operand register or retained operation instruction.

[IC]

- Prints/displays the item counter.
- Pressing the key once prints the item counter with the \diamond symbol.
- Pressing the key consecutively twice prints the item counter with the * symbol, feeds the paper one line, and clears the item counter.
- The displayed/printed numeric value is processed.
- Even if neither [IC+] or [IC \pm] is not selected, this key is valid.

[M+]

- Adds to the memory register and performs a floating point representation on the memory value regardless of the TAB specification.
- If the operation status is not retained, or in constant mode, adds the displayed value to the memory register, and prints the result with the M+ symbol. Does not cancel constant mode.
- After performing the retained operation (addition, subtraction, multiplication, or division), rounds the result according to the TAB specification, and adds the result to the memory register. Prints the result with the M+ symbol, then feeds the paper one line. Does not cancel constant mode.
- Pressing the key following the [+] or [-] key does not perform the operation but just prints the = symbol, rounds the displayed value according to the TAB specification, and adds the result to the memory register. Prints the result with the M+ symbol, then feeds the paper one line.

[M-]

- Subtracts the memory register, and performs a floating point representation on the memory value regardless of the TAB specification.
- If the operation status is not retained, or in constant mode, subtracts the displayed value from the memory register, and prints the result with the M- symbol. Does not cancel constant mode.
- After performing the retained operation (addition, subtraction, multiplication, or division), rounds the result according to the TAB specification, and subtracts the result from the memory register. Prints the result with the M- symbol, then feeds the paper one line. Does not cancel constant mode.
- Pressing the key following the [+] or [-] key does not perform the operation but just prints the = symbol, rounds the displayed value according to the TAB specification, and subtracts the result from the memory register. Prints the result with the M- symbol, then feeds the paper one line.

[MR]

- Prints/displays the memory register.
- Prints the memory register as is with the M \diamond symbol regardless of the TAB specification.
- The printed/displayed numeric value is processed.

[MC]

- Clears the memory register.
- Prints just the M* symbol. Does not affect operation or numeral entry.

[MR/C]

- Pressing the key once functions the same as the [MR] key. Pressing the key consecutively twice, functions the same as the [MC] key.

[+TAX]

- Performs TAX operation (amount including tax). Calculates the amount of tax, then calculates the total amount including tax. Prints both figures with the \diamond symbol and * symbol, respectively.
- Prints the amount including tax and feeds the paper one line.
- Prints the tax rate with the % symbol.
- If the operation status is not retained, or in constant mode, performs TAX operation on the displayed value and cancels constant mode.
- After performing the retained operation (addition, subtraction, multiplication, or division), rounds the result according to the TAB specification, and performs the TAX operation on the result. Does not set constant mode.
- Pressing the key following the [+] or [-] key does not perform the operation but just prints the = symbol, rounds the displayed value according to the TAB specification, and performs the TAX operation on the result.
- Regards any errors during tax operation as system errors. Regards any errors during calculation of the amount including tax as rough estimation errors.

[-TAX]

- Performs TAX operation (amount excluding tax). Calculates the amount excluding tax, then calculates the amount of tax. Prints both figures with the \diamond symbol and * symbol, respectively.
- Prints the amount excluding tax and feeds the paper one line.
- Prints the tax rate with the % symbol.
- If the operation status is not retained, or in constant mode, performs TAX operation on the displayed value and cancels constant mode.
- After performing the retained operation (addition, subtraction, multiplication, or division), rounds the result according to the TAB specification, and performs the TAX operation on the result. Does not set constant mode.
- Pressing the key following the [+] or [-] key does not perform the operation but just prints the = symbol, rounds the displayed value according to the TAB specification, and performs the TAX operation on the result.
- Regards any errors during tax amount operation as system errors. Regards any errors during calculation of the amount excluding tax as rough estimation errors.

[MII+]

- Except that pressing the key prints --2-- and uses the second memory register, this key functions the same as the [M+] key.

[MII-]

- Except that pressing the key prints --2-- and uses the second memory register, this key functions the same as the [M-] key.

[MIIR]

- Except that pressing the key prints --2-- and uses the second memory register, this key functions the same as the [MR] key.

[MIIC]

- Except that pressing the key prints --2-- and uses the second memory register, this key functions the same as the [MC] key.

[MRH/C]

- Except that pressing the key prints --2-- and uses the second memory register, this key functions the same as the [MR/C] key.

[+TAXH]

- Except that pressing the key prints --2-- and uses the second TAX register, this key functions the same as the [+TAX] key.

[-TAXH]

- Except that pressing the key prints --2-- and uses the second TAX register, this key functions the same as the [-TAX] key.

[DEC]

- Valid only in touch key mode.
- Switches TAB specification. At reset, floating point (F) is set.
- Repeats F → 0 → 1 → 2 → 3 → 4 → 6 → A → AH → F → 0. Displays the specified decimal point and add mode status using flags.

[ROUND]

- Valid only in touch key mode.
- Switches raising, truncating, and rounding up/down. At reset, rounding up/down is set.
- Repeats rounding up/down → truncating → raising → rounding up/down → truncating → raising. Displays the status using flags.

[NP/P]

- Valid only in touch key mode.
- Switches print mode. At reset, non-print mode is set.
- Repeats non-print → print → non-print. Displays the status using flags.

[ICMOD]

- Valid only in touch key mode.
- Switches item counter mode. At reset, no mode specification is set.
- Repeats no-mode → IC+ → IC± → no-mode. Displays the status using flags.

[GTMOD]

- Valid only in touch key mode.
- Switches GT mode. At reset, no mode specification is set.
- Repeats no-mode → GT mode → no-mode. Displays the status using flags.

[SET]

- Valid only in touch key mode.
- Switches TAX register (tax rate) setting mode. At reset, no mode specification is set.
- Repeats operation mode → setting mode → operation mode. During setting mode, the flags indicating status blink.
- If setting mode is maintained for about three minutes and no operation is performed, the mode is automatically canceled.
- Immediately after switching from calculation mode to setting mode, the retained operation status, constant mode, and constant are cleared. Functions the same as pressing the [C] key.
- When switching from calculation mode to setting mode, prints the TAX register with the % symbol, then feeds the paper one line. If no settings are made in setting mode, switching to calculation mode does not print.

[SETII]

- Except that pressing the key prints "--2--" and uses the second memory register, this key functions the same as the [SET] key.

(3) Explanation of lock keys

[0-1-2-3-4-6-A-AII]

- Valid only in lock key mode.
- Specifies TAB. If no specification is made, floating point (F) is used.

[CUT] [UP]

- Valid only in lock key mode.
- In CUT mode, truncating is performed; in UP mode, raising. If no specification is made, rounding up or down is performed.

[NP/P]

- Valid only in lock key mode.
- Switches print modes.
- When switching from non-print to print mode, feeds the paper one line.

[IC+], [IC±]

- Valid only in lock key mode.
- Selects IC+ or IC±.

[GT]

- Valid only in lock key mode.
- Specifies GT mode.

[SET/CAL]

- Valid only in lock key mode.
- Functions the same as the touch [SET] key. Valid except for a printer error or key buffer error. (at rough estimation error or system error, the error status is automatically canceled.)
- When the key is on, prints/displays the TAX register.
- Turning off after numeral entry retains the displayed data as the new tax rate in the TAX register.

[SETII/CAL]

- Valid only in lock key mode.
- Except that pressing the key prints "--2--" and uses the second TAX register, this key functions the same as the [SET/CAL] key.

[FEED]

- Valid in both lock and touch key modes.
- Feeds the paper one line. Keep the key pressed feeds the paper continuously.
- Valid even in non-print mode.

(4) ON, OFF keys

In touch key mode

- Pressing the [OFF] key enters HOLD mode.
- When entered in HOLD mode by the [OFF] key or the auto power off function, pressing the [ON/C or ON/C, CE] key cancels HOLD mode.
- When HOLD mode is canceled, the memory, TAX, and GT registers are retained. Clears everything else, prints 0. *, then feeds the paper one line.

In lock key mode

- Setting the lock keys to off enters HOLD mode; to on, cancels HOLD mode.
- When HOLD mode is entered by the auto power off function, turning the lock keys to off, then on, cancels HOLD mode.
- When HOLD mode is canceled, the memory, TAX, and GT registers are retained. Clears everything else, prints 0.*, then feeds the paper one line.

(5) Optional switch

- The following optional switches are detected immediately after reset only.

[TMR]

- When this key is on, the auto power off function operates for about six minutes.

[T/L]

- When the key is on, touch key mode is entered; when off, lock key mode.

[2 M]

- Specifies the number of memory registers.
- When the key is on, one memory register is selected; when off, two memory registers.

[2 TAX]

- Specifies the number of TAX registers.
- When the key is on, a TAX register is selected; when off, two TAX registers.

[ON/C or ON/C, CE]

- Specifies the function added to the ON key: [C] or [C/CE].

(6) Operations

Operation method

- Operates according to formulas.
- The number of effective digits is 10, same as the display. If an operation result exceeds the number of effective digits, the decimal fraction part is unconditionally truncated.
- Tabulation (TAB) processing is performed on the operation result after the fraction part is truncated. TAB processing includes rounding up and down, truncating, and raising the value of the digit one below the specified decimal point. For floating points, all values are truncated.
- When the operation result is 0, the sign must be positive.
- Intermediate values for addition, subtraction, multiplication, or division are displayed as a floating representation regardless of the TAB specification.

Operation types

- Four operations: addition, subtraction, multiplication, and division operation using the [+], [-], [×], [÷], and [=] keys
- Power, reciprocal operations
 - a [×] [=]..... pressing [=] for n – 1 times gives a to the power of n.
 - a [÷] [=]..... pressing [=] for n + 1 times gives a to the power of –n.
- Percentage operations
 - a [×] b [%] calculates ab/100.
 - a [×] [%] calculates a²/100.
 - a [÷] b [%] calculates 100a/b.

- Add-on operations
a [+] b [%] calculates $a + ab/100$.
Then, c [%] calculates $a + ac/100$.
Or, a [×] b [%] calculates $ab/100$, then [+] [=] calculates $a + ab/100$.
- Percent discount operations
a [-] b [%] calculates $a - ab/100$.
Then, c [%] calculates $a - ac/100$.
Or, a [×] b [%] calculates $ab/100$, then [-] [=] calculates $a - ab/100$.
- Mark-up operations
a [×] b [MU] calculates $a/(1 - b/100)$.
Then, [MU] calculates $a/(1 - b/100) - a$.
- Mark-down operations
a [÷] b [MU] calculates $a/(1 + b/100)$.
Then, [MU] calculates $a/(1 + b/100) - a$.
- Change rate operations
a [+] b [MU] calculates $100(a + b)/b$
a [-] b [MU] calculates $100(a - b)/b$
- TAX operations
Tax rate: b%
a [+TAX] calculates $ab/100 + a$.
a [-TAX] calculates $a/(1 + b/100)$

Constant operations

- When a calculation ends after the [=] and [%] keys are pressed, constant mode is automatically entered.
- In multiplication, the operand is retained as a constant; in addition, subtraction, and division, the operator is retained as the constant.
- The results of addition, subtraction, multiplication, and division are all retained. There is no need to enter numerals again. Pressing the [=] and [%] keys calculates the retained constant using the displayed value.
- Note that the [%] key does not function in constant mode for addition and subtraction.
- Percent discount and add-on operations using the [%] key do not enter constant mode.
- Constant mode is canceled by clearing the operation status or pressing the [+], [-], [×], or [÷] key again.

Mixed operations

- After a calculation ends with the [=] and [%] keys, pressing the [+], [-], [×], or [÷] key again without re-entering numerals performs the next calculation using the result of the previous calculation.

Add mode operation

- Automatically performs 1/100 on the numeral entered. If the numeral includes the [·] key, the entry is used for the calculation as is.
- To print or display the values in add mode, the value after 1/100 is used.
- When TAB = A, add mode operation is valid for the following:
The [+], [-], [M+], [M-], [MII+], or [MII-] key after the first numeral entry.
When TAB = A, and with addition or subtraction retained, add mode operation is valid for the following:
The [+], [-], [×], [÷], [=], [M+], [M-], [MII+], [MII-], [+TAX], [-TAX], [+TAXII] or [-TAXII] key.
- When TAB = AII, with multiplication or division retained, add mode operation is valid for the following:
The [+], [-], [×], [÷], [=], [M+], [M-], [MII+], [MII-], [+TAX], [-TAX], [+TAXII] or [-TAXII] key.

(7) Others

Low-power specification

- During standby for key entry, the system operates at low speed; during operation and printing, at high speed. Thus, the CPU supports two clock frequencies.

[ON/C and ON/C, CE] key specification

- In touch key mode, the [ON/C and ON/C, CE] key also functions as the [C] or [C/CE] key.
- To select the function, [C] or [C/CE], use the option switch.

Operation Example

Key 10 9 8 7 6 5 4 3 2 1	Print 13 12 11 10 9 8 7 6 5 4 3 2 1	Display		Lock Key			
		10 9 8 7 6 5 4 3 2 1	SYM	TAB	RND	NP	GT
ACL (POWER ON)				F	5/4	OFF	OFF
	<1 Line Auto Space>						
	0. *	0.					
	<1 Line Auto Space>						
Standard 4 function							
125		125.					
+	125. +	125.					
345		345.					
=	345. =						
	470. *	470.					
	<1 Line Auto Space>						
100		100.					
=	100. =	100.					
	445. *	445.					
	<1 Line Auto Space>						
×	445. ×	445.					
10		10.					
=	10. =						
	4450. *	4450.					
	<1 Line Auto Space>						
I C	003 0	3.					
I C	003 *	3.					
	<1 Line Auto Space>						
999999999		9'999'999'999.					
÷	999999999. ÷	9'999'999'999.					
3		3.					
=	3. =						
	333333333. *	3'333'333'333.					
	<1 Line Auto Space>						
-	333333333. -	3'333'333'333.					
999999999		9'999'999'999.					
=	999999999. =						
	-666666666. *	-6'666'666'666.					
	<1 Line Auto Space>						
+ / -		6'666'666'666.					
+	666666666. +	6'666'666'666.					
3		3.					
+ / -		-3.					
+	3. +	6'666'666'663.					
÷		6'666'666'663.					
×		6'666'666'663.					
-		6'666'666'663.					

Key 10 9 8 7 6 5 4 3 2 1	Print 13 12 11 10 9 8 7 6 5 4 3 2 1	Display				Lock Key			
		10 9 8 7 6 5 4 3 2 1	SYM	TAB	RND	NP	GT		
=	=	6'666'666'663.		F	5/4	OFF	OFF		
	6666666663. *	6'666'666'663.							
	<1 Line Auto Space>								
345		345.							
x	345. x	345.							
=	345. =								
	119025. *	119'025.							
	<1 Line Auto Space>								
=	119025. =	119'025.							
	41063625. *	41'063'625.							
	<1 Line Auto Space>								
10		10.							
÷	10. ÷	10.							
=	10. =								
	1. *	1.							
	<1 Line Auto Space>								
=	1. =								
	0.1 *	0.1							
	<1 Line Auto Space>								
=	0.1 =								
	0.01 *	0.01							
	<1 Line Auto Space>								
9999999999		9'999'999'999.							
+	9999999999. +	9'999'999'999.							
1		1.							
=	1. =								

	1.000000000 *	1.000000000	E						
	<1 Line Auto Space>								
C E		1.000000000							
C	0. *	0.							
	<1 Line Auto Space>								
Percentage									
Calculation									
10000		10'000.							
x	10000. x	10'000.							
12		12.							
%	12. %								
	1200. *	1'200.							
	<1 Line Auto Space>								
25		25.							
%	25. %								

Key 10 9 8 7 6 5 4 3 2 1	Print 13 12 11 10 9 8 7 6 5 4 3 2 1	Display				Lock Key			
		10 9 8 7 6 5 4 3 2 1	SYM	TAB	RND	NP	GT		
	2500. *	2'500.		F	5/4	OFF	OFF		
	<1 Line Auto Space>								
9		9.							
=	9. =								
	90000. *	9'000.							
	<1 Line Auto Space>								
10000		10'000.							
÷	10000. ÷	10'000.							
20000		20'000.							
%	20000. %								
	50. *	50.							
	<1 Line Auto Space>								
50000		50'000.							
%	50000. %								
	250. *	250.							
	<1 Line Auto Space>								
10		10.							
=	10. =								
	0.0005. *	0.0005							
	<1 Line Auto Space>								
100		100.							
+	100. +	100.							
20		20.							
×	20. ×	120.							
5		5.							
%	5. %								
	6. *	6.							
	<1 Line Auto Space>								
Percentage Discount									
Calculation									
10000		10'000.							
×	10000. ×	10'000.							
23		23.							
%	23. %								
	2300. *	2'300.							
	<1 Line Auto Space>								
+	2300. +	2'300.							
=	12300. *	12'300.							
	<1 Line Auto Space>								
=		12'300.							
%		12'300.							
C / C E	0. *	0.							
	<1 Line Auto Space>								

Key 10 9 8 7 6 5 4 3 2 1	Print 13 12 11 10 9 8 7 6 5 4 3 2 1	Display				Lock Key			
		10 9 8 7 6 5 4 3 2 1	SYM	TAB	RND	NP	GT		
10000		10'000.		F	5/4	OFF	OFF		
+	10000. ×	10'000.							
23		23.							
%	23. %								
	12300. *	12'300.							
	<1 Line Auto Space>								
=	12300. =								
	22300. *	22'300.							
	<1 Line Auto Space>								
C E		22'300.							
C	0. *	0.							
	<1 Line Auto Space>								
10000		10'000.							
×	10000. ×	10'000.							
23		23.							
%	23. %								
	2300. *	2'300.							
	<1 Line Auto Space>								
-	2300. -	2'300.							
=	7700. *	7'700.							
	<1 Line Auto Space>								
10000		10'000.							
-	10000. -	10'000.							
23		23.							
%	23. %								
	7700. *	7'700.							
	<1 Line Auto Space>								
=	7700. =								
	-2300. *	-2'300.							
	<1 Line Auto Space>								
100		100.							
÷	100. ÷	100.							
5		5.							
%	5. %								
	2000. *	2'000							
	<1 Line Auto Space>								
+	2000. +	2'000							
=	=								
	2000. *	2'000							
	<1 Line Auto Space>								
9999999999		9'999'999'999.							
+	9999999999. +	9'999'999'999.							
10		10.							

Key 10 9 8 7 6 5 4 3 2 1	Print 13 12 11 10 9 8 7 6 5 4 3 2 1	Display		Lock Key			
		10 9 8 7 6 5 4 3 2 1	SYM	TAB	RND	NP	GT
%	10. %			F	5/4	OFF	OFF

	10.99999999 *	10.99999999	E				
	<1 Line Auto Space>						
C E		10.99999999					
9999999999		9'999'999'999.					
×	9999999999. ×	9'999'999'999.					
1000		1'000.					
%	1000. %						

	9.999999999 *	9.999999999	E				
	<1 Line Auto Space>						
C E		9.999999999					
+	9.999999999 +	9.999999999					
=	-----						
	1.000000000 *	1.000000000					
	<1 Line Auto Space>						
Memory							
Calculation							
12.35		12.35		0			
M +	12.35 M +	12.35	M				
12.350		12.350	M				
M +	12.350 M +	12.350	M				
M R	24.7 M ∅	24.7	M				
34		34.	M				
M C	M *	34.					
5		345.					
×	345. ×	345.					
6	6. =						
M +	2070. M +	2070.	M				
	<1 Line Auto Space>						
10		10.	M	2			
+	10. +	10.	M				
234		234.	M				
M -	234. =						
	244.00 M -	244.00	M				
	<1 Line Auto Space>		M				
M R	1826. M ∅	1826.	M				
11.123456		11.123456	M				
÷	11.123456 ÷	11.123456	M				
10		10.	M				
M +	10. =						
	1.11 M +	1.11	M				

Key 10 9 8 7 6 5 4 3 2 1	Print 13 12 11 10 9 8 7 6 5 4 3 2 1	Display		Lock Key			
		10 9 8 7 6 5 4 3 2 1	SYM	TAB	RND	NP	GT
	<1 Line Auto Space>			2	5/4	OFF	OFF
9999999999		9'999'999'999.	M				
M +	9999999999. M +						

	1.000000182 *	1.000000182	ME				
	<1 Line Auto Space>						
C E		1.000000182	M				
C	0. *	0.	M	4			
	<1 Line Auto Space>						
M R	1827.11 M 0	1827.11	M				
M C	M *	1827.11					
Gross Profit Margin				3			
Calculation							
250		250.					
x	250. x	250.					
25		25.					
M U	25. M %						
	333.333 *	333.333					
	<1 Line Auto Space>			F			
M U	83.33333 *	83.33333					
	<1 Line Auto Space>						
9999999999		9'999'999'999.					
x	9999999999. x	9'999'999'999.					
1							
M U	1. M %	1.					

	0. *	0.	E				
	<1 Line Auto Space>						
C E		0.	E				
C	0. *	0.					
	<1 Line Auto Space>						
120		120.					
÷	120. ÷	120.					
20		25.					
M U	20. M %						
	100. *	100.					
	<1 Line Auto Space>						
M U	20. *	20.					
	<1 Line Auto Space>						
9999999999		9'999'999'999.					
÷	9999999999. x	9'999'999'999.					
1		1.					
+ / -		-1.					

Key 10 9 8 7 6 5 4 3 2 1	Print 13 12 11 10 9 8 7 6 5 4 3 2 1	Display		Lock Key			
		10 9 8 7 6 5 4 3 2 1	SYM	TAB	RND	NP	GT
M U	-1. M %			F	5/4	OFF	OFF

	0. *	0.	E				
	<1 Line Auto Space>						
C	0. *	0.					
	<1 Line Auto Space>						
Delta Percentage				4			
Calculation							
100		100.					
-	100. -	100.					
25		25.					
M U	25. M %						
	300.0000 *	300.0000.					
	<1 Line Auto Space>						
125		125.					
M U	125. M %						
	400.0000 *	400.0000.					
	<1 Line Auto Space>						
100		100.					
+	100. +	100.					
25		25.					
M U	25. M %						
	500.0000 *	500.0000.					
125		125.					
M U	125. M %						
	600.0000 *	600.0000					
	<1 Line Auto Space>						
M U	600.0000 M %						
	2500.0000 *	2'500.0000					
	<1 Line Auto Space>						
-	2500.0000 -	2'500.0000					
M U		2'500.0000					
C	0. *	0.					
	<1 Line Auto Space>						
9999999999		9'999'999'999.					
-	9999999999. -	9'999'999'999.					
0.1		0.1					
M U	0.1 M %						

	0. *	0.	E				
C E		0.	E				
C	0. *	0.					
	<1 Line Auto Space>						

Key 10 9 8 7 6 5 4 3 2 1	Print 13 12 11 10 9 8 7 6 5 4 3 2 1	Display					Lock Key			
		10 9 8 7 6 5 4 3 2 1	SYM	TAB	RND	NP	GT			
Comment Print				F	5/4	OFF	OFF			
1234		1'234.								
# / P	#1234.	1'234.								
# / P	1234.	1'234.								
0009876543		9'876'543.								
# / P	#9876543	9'876'543.								
99.09.30		99.0930								
# / P	#99.09.30	99.0930								
# / P	99.0930	99.0930		2		ON				
+		99.0930								
2		2.								
+		101.093								
=		101.09								
# / P	101.09									
	<1 Line Auto Space>							OFF		
1234		1'234.		F						
→		123.								
+ / -		-123.								
+ / -		123.								
+ / -		-123.								
5		-1235.								
# / P	#-1235	-1235.								
C E		0.								
Root Caluculation										
2.2		2.2								
→		2.								
	2.									
	1.414213562 *	1.414213562								
×	1.414213562 ×									
10										
=	10. =									
	1.414213562 *	14.14213562								
	<1 Line Auto Space>									
→		14.14213562								
# / P	14.14213562	14.14213562								
C E		14.14213562								
C	0. *	0.								
	<1 Line Auto Space>									
Adding Calculation										
123		123.								
+	123. +	123.								
256		256.		A						
×	2.56 +	125.56								

Key 10 9 8 7 6 5 4 3 2 1	Print 13 12 11 10 9 8 7 6 5 4 3 2 1	Display				Lock Key			
		10 9 8 7 6 5 4 3 2 1	SYM	TAB	RND	NP	GT		
3		3.		A	5/4	OFF	OFF		
×	3. ×	376.68							
=	376.68 =								
	141887.82 *	141'887.82							
	<1 Line Auto Space>								
123		123.		All	CUT				
+	123. +	123.							
256		256.							
×	256. ×	379.							
3		3.							
×	0.03 ×	11.37							
=	11.37 =								
	129.27 *	129.27							
	<1 Line Auto Space>								
543		543.		A	5/4				
M +	5.43 M +	5.43	M						
6		6.	M						
M +	0.06 M +	0.06	M						
5.		5.	M						
M +	5. M +	5.	M						
M R	10.49 M ◊	10.49	M						
999		999.	M	All					
-	999. -	999.	M						
1234		1'234.	M						
×	1234. +	-235.	M						
111		111.	M						
×	1.11 ×	-260.85	M						
2		2.	M						
M -	0.02 =								
	-5.22 M -	-5.22	M						
	<1 Line Auto Space>								
M R	15.71 M ◊	15.71	M						
M C	M *								
GT Calculation				F					
100		100.							
+	100. +	100.							
25		25.							
=	25. =								
	125. * +	125.	G						
	<1 Line Auto Space>								
C	0. *	0.	G						
	<1 Line Auto Space>								
G T	125. * ◊	125.	G						

Key 10 9 8 7 6 5 4 3 2 1	Print 13 12 11 10 9 8 7 6 5 4 3 2 1	Display					Lock Key			
		10 9 8 7 6 5 4 3 2 1	SYM	TAB	RND	NP	GT			
100				F	5/4	OFF	OFF			
×	100. ×	100.	G							
5		5.	G							
%	5. %									
	5. * +	5.	G							
	<1 Line Auto Space>									
G T	130. * ◊	130.	G							
G T	130. * *	130.								
	<1 Line Auto Space>									
3333333333		3' 333' 333' 333.								
+	3333333333. +									
6666666666		6' 666' 666' 666.								
=	6666666666. =									
	9999999999. * +	9' 999' 999' 999.	G							
	<1 Line Auto Space>									
3		3.	G							
=	3. =									
	6666666669. * +									

	1.666666666 * *	1.666666666	GE							
	<1 Line Auto Space>									
C E		1.666666666	G							
C	0. * *	0.	G							
	<1 Line Auto Space>									
G T	9999999999. * ◊	9' 999' 999' 999.	G							
G T	9999999999. * *	9' 999' 999' 999.								
	<1 Line Auto Space>									
MemoryII										
Calculation										
123.456		123.456								
MI +	--2--									
	125.456 M +	123.456	MI							
100.001		100.001	MI							
MI +	--2--									
	100.001 M +	100.001	MI							
MI R	--2--									
	223.456 M ◊	223.456	MI							
MI C	--2--									
	M *	223.456								
9999999999		9' 999' 999' 999.								
×	9999999999. ×	9' 999' 999' 999.								
1		1.								
MI +	1. =									

Key 10 9 8 7 6 5 4 3 2 1	Print 13 12 11 10 9 8 7 6 5 4 3 2 1	Display		Lock Key			
		10 9 8 7 6 5 4 3 2 1	SYM	TAB	RND	NP	GT
	--2--			F	5/4	OFF	OFF
	9999999999. M +	9'999'999'999	MI				
3		3.	MI				
	--2--						
MII +	3. M +						

	1.000000000. *	1.000000000	MIE				
	<1 Line Auto Space>						
C	0. *	0.	MI				
	<1 Line Auto Space>						
MII R	--2--						
	9999999999. M 0	9'999'999'999.	MI				
6666666666		6'666'666'666.	MI				
MII -	--2--						
	6666666666. M -	6'666'666'666.	MI				
MII -	--2--						
	6666666666. M -	6'666'666'666.	MI				
MII R	--2--						
	-3333333333. M 0	-3'333'333'333.	MI				
MII C	--2--						
	M *	-3'333'333'333.					
Tax Caluculation							
SET	0. %	0.					
	<1 Line Auto Space>						
3		3.					
CAL	3. %	3.					
	<1 Line Auto Space>						
1560		1560.					
+ T A X	1560.						
	3. %						
	46.8 0						
	1606.8 *	1'606.8					
	<1 Line Auto Space>						
1560		1560.					
- T A X	1560.						
	3. %						
	45.436894 0						
	1514.563106 *	1'514.563106					
	<1 Line Auto Space>						
SET	3. %	3.					
	<1 Line Auto Space>						
5		5.					
CAL	5. %	5.					

Key 10 9 8 7 6 5 4 3 2 1	Print 13 12 11 10 9 8 7 6 5 4 3 2 1	Display		Lock Key			
		10 9 8 7 6 5 4 3 2 1	SYM	TAB	RND	NP	GT
	<1 Line Auto Space>			F	5/4	OFF	OFF
9000000000		9'000'000'000.					
+ T A X	90000000000.						
	5. %						
	450000000. ◊						
	9450000000. *	9'450'000'000.					
	<1 Line Auto Space>						
100		100.					
x	100. x	100.					
2		2.					
+ T A X	2. =						
	200. ◊						
	5. %						
	10. ◊						
	210. *	210.					
	<1 Line Auto Space>						
100		100.					
+	100. +	100.					
200		200.					
+ T A X	200. =						
	300. ◊						
	5. %						
	15. ◊						
	315. *	315.					
	<1 Line Auto Space>						
9999999999		9'999'999'999.					
+ T A X	9999999999.						
	5. %						
	4999999999.5 ◊						

	1.0499999999 *	1.0499999999	E				
	<1 Line Auto Space>						
C	0. *	0.					
	<1 Line Auto Space>						
9000000000		9'000'000'000.					
+	9000000000. +	9'000'000'000.					
1000000000		1'000'000'000.					
+ T A X	1000000000. =						

	0. *	0.	E				
	<1 Line Auto Space>						
C E		0.					
C	0. *	0.					

Key 10 9 8 7 6 5 4 3 2 1	Print 13 12 11 10 9 8 7 6 5 4 3 2 1	Display					Lock Key			
		10 9 8 7 6 5 4 3 2 1	SYM	TAB	RND	NP	GT			
	<1 Line Auto Space>			F	5/4	OFF	OFF			
9000000000		9'000'000'000.								
+	9000000000. +	9'000'000'000.								
+ T A X	=									
	5. %									
	450000000. ◊									
	9450000000. *	9'450'000'000.								
	<1 Line Auto Space>									
C	0. *									
	<1 Line Auto Space>									
Tax CalculationII										
SETH	--2--									
	0. %	0.								
	<1 Line Auto Space>									
3		3.								
CAL	--2--									
	3. %	3.								
	<1 Line Auto Space>									
1560		1560.								
+T A XII	--2--									
	1560.									
	3. %									
	46.8 ◊									
	1606.8 *	1'606.8								
	<1 Line Auto Space>									
1560		1560.								
-T A XII	--2--									
	1560.									
	3. %									
	45.436894 ◊									
	1514.563106 *	1'514.563106								
	<1 Line Auto Space>									
SETH	--2--									
	3. %	3.								
	<1 Line Auto Space>									
6		5.								
CAL	--2--									
	6. %	5.								
	<1 Line Auto Space>									
9000000000		9'000'000'000.								
+T A XII	--2--									
	90000000000.									
	6. %									

Key 10 9 8 7 6 5 4 3 2 1	Print 13 12 11 10 9 8 7 6 5 4 3 2 1	Display		Lock Key			
		10 9 8 7 6 5 4 3 2 1	SYM	TAB	RND	NP	GT
	540000000. 0			F	5/4	OFF	OFF
	9540000000. *	9'540'000'000.					
	<1 Line Auto Space>						
100		100.					
x	100. x	100.					
2		2.					
+T A XII	--2--						
	2. =						
	200. 0						
	6. %						
	12. 0						
	212. *	212.					
	<1 Line Auto Space>						
100		100.					
+	100. +	100.					
200		200.					
+T A XII	--2--						
	200. =						
	300. 0						
	6. %						
	18. 0						
	318. *	318.					
	<1 Line Auto Space>						
999999999		9'999'999'999.					
+T A XII	--2--						
	999999999.						
	6. %						
	499999999.5 0						

	1.049999999 *	1.049999999	E				
	<1 Line Auto Space>						
C	0. *	0.					
	<1 Line Auto Space>						
900000000		9'000'000'000.					
+	9000000000. +	9'000'000'000.					
1000000000		1'000'000'000.					
+T A XII	--2--						
	1000000000. =						

	0. *	0.	E				
	<1 Line Auto Space>						
C	0. *	0.					
	<1 Line Auto Space>						

Key 10 9 8 7 6 5 4 3 2 1	Print 13 12 11 10 9 8 7 6 5 4 3 2 1	Display				Lock Key			
		10 9 8 7 6 5 4 3 2 1	SYM	TAB	RND	NP	GT		
Off/On				F	5/4	OFF	OFF		
123		123.							
M +	123. M +	123.	M						
456		456.							
MII +	--2--								
	456. M +	456.	MMII						
100		100.	MMII						
+	100. +	100.	MMII						
25		25.	MMII						
=	25. =								
	125. * +	125.	GMMII						
	<1 Line Auto Space>								
E X	25. #	25.	GMMII						
E X	125. #	125.	GMMII						
O F F									
O N	0. *	0.	GMMII						
	<1 Line Auto Space>								
M R	123. M ∅	123.	GMMII						
MII R	--2--								
	456. M ∅	456.	GMMII						
G T	125. * ∅	125.	GMMII						
G T	125. * *	125.	MMII						
	<1 Line Auto Space>								
MII C	--2--								
	M *	125.	M						
M C	M *	125.							
SET	5. %	5.							
	<1 Line Auto Space>								
CAL		5.							
SETH	--2--								
	6. %	6.							
	<1 Line Auto Space>								
CAL		6.							
C	0. *	0.							
	<1 Line Auto Space>								

Maximum Ratings ($V_{SS} = 0\text{ V}$)

Characteristics	Symbol	Rating	Unit
Supply voltage 1	V_{DD}	-0.3~6	V
Supply voltage (LCD drive)	V_{LC}	-0.3- $V_{DD} + 0.3$	V
Input voltage	V_{IN}	-0.3- $V_{DD} + 0.3$	V
Output voltage	V_{OUT}	-0.3- $V_{DD} + 0.3$	V
Output current	I_{OUT}	3.2	mA
Power dissipation	P_D	600	mW
Soldering temperature	T_{sld}	260 (10 s)	°C
Storage temperature	T_{stg}	-55~125	°C
Operating temperature	T_{opr}	0~40	°C

Electrical Characteristics

Recommended Operating Conditions ($V_{SS} = 0\text{ V}$, $T_{opr} = 0\sim 40\text{°C}$)

Characteristics	Symbol	Test Circuit	Test Condition	Min	Typ.	Max	Unit
Operating temperature	T_{opr}	—	—	0	—	40	°C
Supply voltage	V_{DD}	—	NORMAL	4.5	—	5.5	V
		—	SLOW				
		—	HOLD	2.0			
High-level input voltage (non-schmitt circuit)	V_{IH1}	—	$V_{DD} \geq 4.5\text{ V}$	$V_{DD} \times 0.7$	—	V_{DD}	V
High-level input voltage (schmitt circuit)	V_{IH2}			$V_{DD} \times 0.75$	—	V_{DD}	V
High-level input voltage	V_{IH3}	—	$V_{DD} < 4.5\text{ V}$	$V_{DD} \times 0.9$	—	V_{DD}	V
Low-level input voltage (non-schmitt circuit)	V_{IL1}	—	$V_{DD} \geq 4.5\text{ V}$	0	—	$V_{DD} \times 0.3$	V
Low-level input voltage (schmitt circuit)	V_{IL2}			0	—	$V_{DD} \times 0.25$	V
Low-level input voltage	V_{IL3}			—	$V_{DD} < 4.5\text{ V}$	0	—

DC Characteristics ($V_{SS} = 0\text{ V}$, $T_{opr} = 0\sim 40^{\circ}\text{C}$)

Characteristics	Symbol	Test Circuit	Terminal	Test Condition	Min	Typ.	Max	Unit
Hysteresis voltage (schmitt circuit)	V_{HS}	—	Hysteresis input	—	—	0.7	—	V
Input current	I_{IN1}	—	KO port, TEST, RESET, HOLD	$V_{DD} = 5.5\text{ V}$ $V_{IN} = 5.5/0\text{ V}$	—	—	± 2	μA
	I_{IN2}	—	Open drain R port, P port					
Input resistance	R_{IN1}	—	KO port TEST with input resistor	$V_{DD} = 5.5\text{ V}$ $V_{IN} = 5.5/0\text{ V}$	30	70	150	$\text{k}\Omega$
	R_{IN2}	—	RESET, HOLD		100	220	450	
Output leakage current	I_{LO1}	—	Sink open drain R port	$V_{DD} = 5.5\text{ V}$ $V_{OUT} = 5.5\text{ V}$	—	—	2	μA
	I_{LO2}	—	Source open drain R port, P port	$V_{DD} = 5.5\text{ V}$ $V_{OUT} = -1.5\text{ V}$	—	—	-2	
High-level output voltage	V_{OH}	—	Source open drain R port, P port	$V_{DD} = 5.5\text{ V}$ $I_{OH} = -1.6\text{ mA}$	2.4	—	—	V
Low-level output voltage	V_{OL}	—	Sink open drain R port	$V_{DD} = 5.5\text{ V}$ $I_{OL} = 1.6\text{ mA}$	—	—	0.4	V
Pull-down resistance	R_{OUT}	—	R port, P port	$V_{DD} = 5.5\text{ V}$ $V_{IN} = 5.5\text{ V}$	30	70	150	$\text{k}\Omega$
Output resistance	R_{OS}	—	SEG	$V_{DD} = 5\text{ V}$ $V_{DD} - V_{LC} = 3\text{ V}$	—	—	35	$\text{k}\Omega$
	R_{OC}	—	COM					
Output voltage	$V_{O2/3}$	—	SEG/COM	$V_{DD} = 5\text{ V}$ $V_{DD} - V_{LC} = 3\text{ V}$	3.8	4.0	4.2	V
	$V_{O1/2}$				3.3	3.5	3.7	
	$V_{O1/3}$				2.8	3.0	3.2	
Supply current (normal)	I_{DD}	—	—	$V_{DD} = 5.5\text{ V}$, $V_{LC} = V_{SS}$ $f_c = 4\text{ MHz}$	—	3	6	mA
Supply current (hold)	I_{DDH}	—	—	$V_{DD} = 5.5\text{ V}$	—	0.5	10	μA

Note 6: Typ. values are guaranteed at $T_{opr} = 25^{\circ}\text{C}$, $V_{DD} = 5\text{ V}$.

Note 7: I_{IN1} : Expects a current through a internal pull up/down resistor.

Note 8: R_{OS} , R_{OC} : Shows on-resistor at level switching.

Note 9: $V_{O2/3}$: Shows 2/3 level output voltage at which 1/4 or 1/3 duty LCD drive.

Note 10: $V_{O1/2}$: Shows 1/2 level output voltage at which 1/2 duty or static LCD drive.

Note 11: $V_{O1/3}$: Shows 1/3 level output voltage at which 1/4 or 1/3 duty LCD drive.

Note 12: I_{DD} , I_{DDH} : Current consumption at $V_{IN} = 5.3\text{ V}/0.2\text{ V}$

Should be under that KO port is open and R port voltage level is valid.

Oscillation Circuit ($V_{SS} = 0\text{ V}$, $V_{DD} = 4.5\sim 5.5\text{ V}$, $T_{opr} = 0\sim 40^\circ\text{C}$)

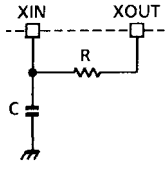
Recommended Circuit	Test Condition	Min	Typ.	Max	Unit
	$V_{DD} = 5.0\text{ V}$ $C = 100\text{ pF}$ $R = 1\text{ k}\Omega \pm 2\%$	2.4	4.0	5.6	MHz

AC Characteristics ($V_{SS} = 0\text{ V}$, $V_{DD} = 4.5\sim 5.5\text{ V}$, $T_{opr} = 0\sim 40^\circ\text{C}$)

Characteristics	Symbol	Test Circuit	Test Condition	Min	Typ.	Max	Unit
Instruction cycle time	t_{CY}	—	NORMAL	1.9	—	20	μs
		—	SLOW	235	—	267	
High-level clock pulse width	t_{WCH}	—	External clock operation	80	—	—	ns
Low-level clock pulse width	t_{WCL}	—					ns
Shift data hold time	t_{SDH}	—	—	$0.5 t_{CY}$ – 300	—	—	ns
High speed timer/counter input frequency	f_{HT}	—	—	—	—	f_c	MHz

Waveforms for Display

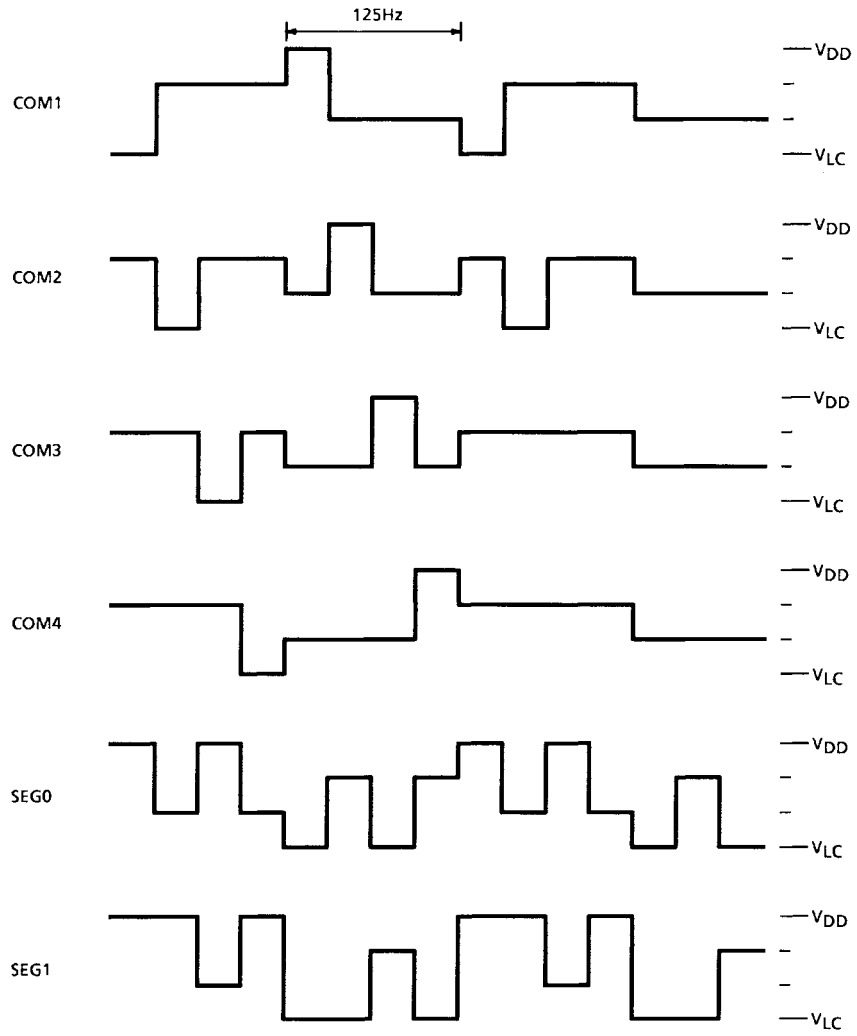

Pad Location Table

(μm)

Name	X Point	Y Point
KO0	-1282	-2074
KO1	-1122	-2074
KO2	-962	-2074
KO3	-802	-2074
R80	-641	-2074
R81	-438	-2074
R82	-278	-2074
R83	-74	-2074
V _{DD}	86	-2074
R90	246	-2074
R91	449	-2074
R92	610	-2074
R40	802	-2074
R41	962	-2074
R42	1122	-2074
R43	1282	-2074
R50	1644	-2011
R51	1644	-1807
R52	1644	-1647
R53	1644	-1444
R60	1644	-1283
R61	1644	-1080
R62	1644	-920
R63	1644	-716
R70	1644	-556
R71	1644	-353
R72	1644	-193
R73	1644	62
SEG0	1644	223
SEG1	1644	383
SEG2	1644	543
SEG3	1644	703
SEG4	1644	863
SEG5	1644	1024
SEG6	1644	1184
SEG7	1644	1344
SEG8	1644	1504
SEG9	1644	1664
SEG10	1644	1825
SEG11	1644	1985

Name	X Point	Y Point
SEG12	1202	2074
SEG13	1042	2074
SEG14	881	2074
SEG15	721	2074
SEG16	561	2074
SEG17	401	2074
SEG18	241	2074
SEG19	80	2074
SEG20	-80	2074
SEG21	-240	2074
SEG22	-400	2074
SEG23	-560	2074
SEG24	-721	2074
SEG25	-881	2074
SEG26	-1041	2074
SEG27	-1201	2074
SEG28	-1644	1961
SEG29	-1644	1801
SEG30	-1644	1641
SEG31	-1644	1481
COM1	-1644	1321
COM2	-1644	1160
COM3	-1644	1000
COM4	-1644	840
V _{LC}	-1644	520
P10	-1644	359
P11	-1644	156
P12	-1644	-4
P13	-1644	-208
V _{SS}	-1644	-368
P20	-1644	-528
P21	-1644	-731
P22	-1644	-892
P23	-1644	-1095
TEST	-1644	-1255
XIN	-1644	-1415
XOUT	-1644	-1651
BRESET	-1644	-1811
BHOLD	-1644	-1971

Chip Layout

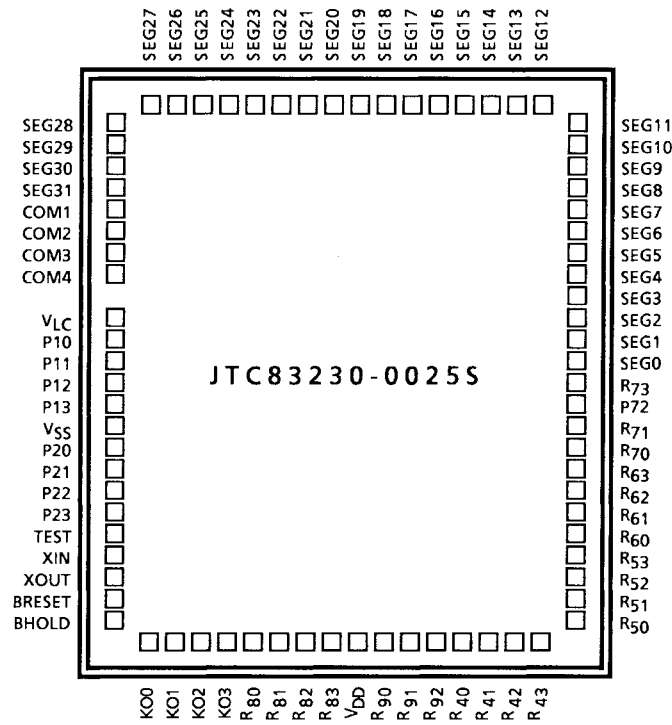

Chip size : 3.78 × 4.67 (mm)
 Chip thickness : 450 ± 30 (μm)
 Substrate : V_{SS}
 Pad size : 100 (μm²)

Pad Layout

Active Element

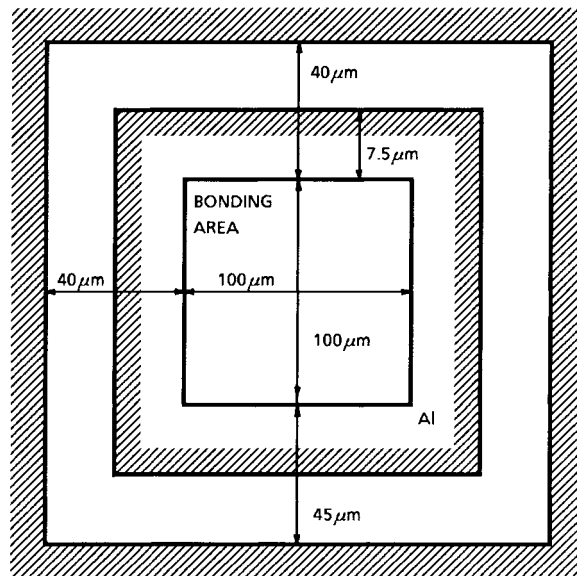

SCRIBE LINE

PAD Pitch : 160 μm

The Proposal of Outer Circuit for Tax Rate Holding with Back-Up Battery.

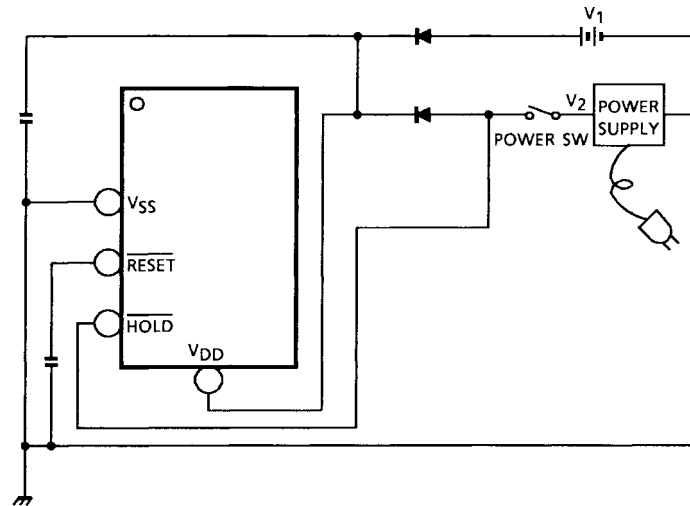

Note 13: $V_1 = +3\text{ V}$: Battery supply

$V_2 = +5\text{ V}$: DC supply

$\overline{\text{HOLD}}$ pin is pulled down in the LSI, but normally pulled up to V_{DD} .

$\overline{\text{RESET}}$ pin is pulled up to V_{DD} .

- (1) Setting POWER SW to ON, V_2 is supplied to V_{DD} pin, and also to $\overline{\text{HOLD}}$ pin. Then calculator operates normally.
- (2) Setting POWER SW from ON to OFF, V_1 is supplied to V_{DD} pin and V_{SS} is supplied to $\overline{\text{HOLD}}$ pin. Under this connection, TAX RATE is held.
- (3) Setting POWER SW to ON, V_2 is supplied to V_{DD} pin, and also to $\overline{\text{HOLD}}$ pin. Then calculator operates normally with TAX RATE to be held.

Note 14: V_1 (battery) should be supplied to the circuit after V_2 (DC) supply, because of prevention from exhaustion of battery and abnormal operation.

Package Dimensions

QFP80-P-1420-0.80A

Unit : mm

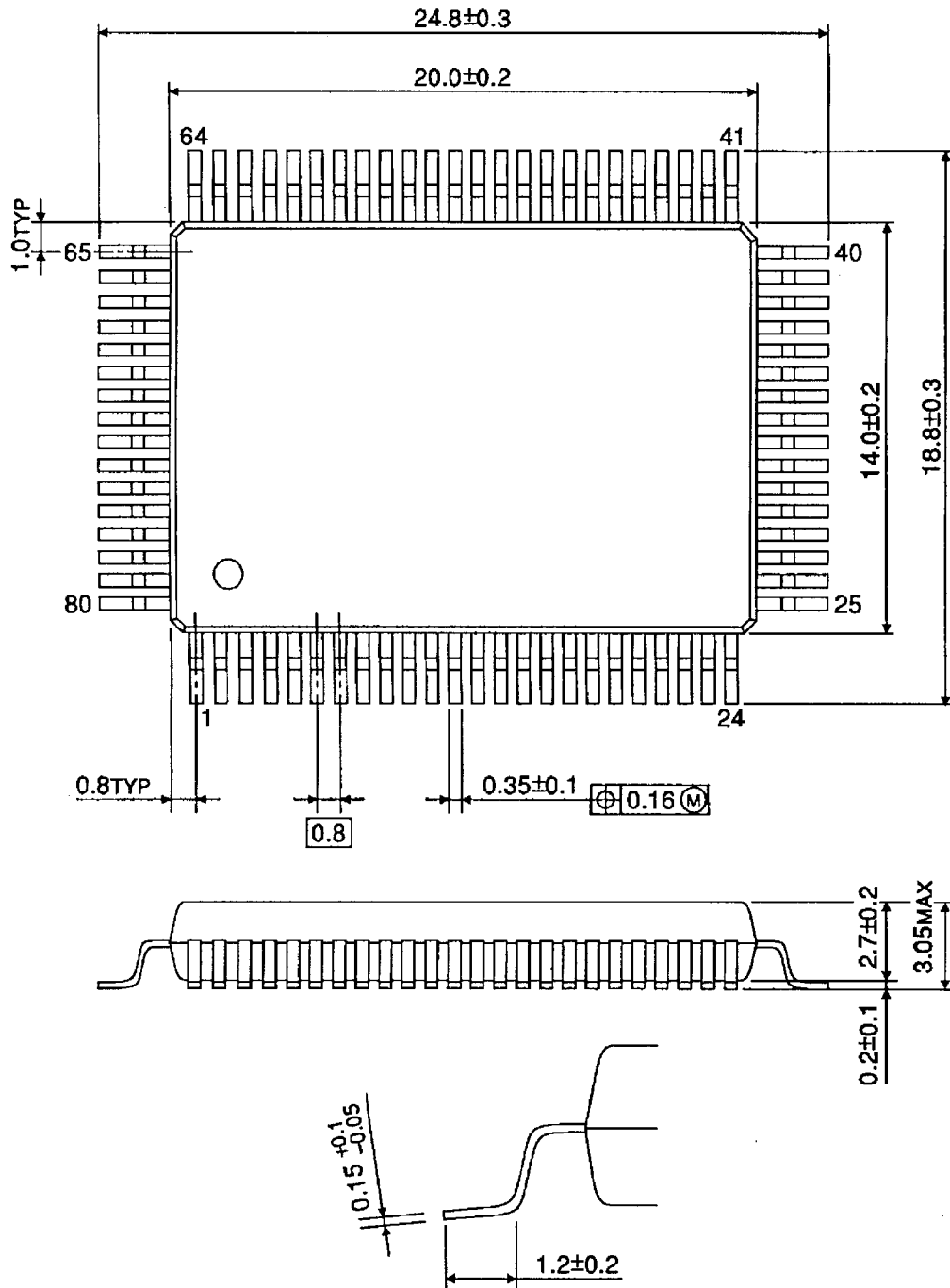

Weight: 1.52 g (typ.)

RESTRICTIONS ON PRODUCT USE

000707EBA

- TOSHIBA is continually working to improve the quality and reliability of its products. Nevertheless, semiconductor devices in general can malfunction or fail due to their inherent electrical sensitivity and vulnerability to physical stress. It is the responsibility of the buyer, when utilizing TOSHIBA products, to comply with the standards of safety in making a safe design for the entire system, and to avoid situations in which a malfunction or failure of such TOSHIBA products could cause loss of human life, bodily injury or damage to property.
In developing your designs, please ensure that TOSHIBA products are used within specified operating ranges as set forth in the most recent TOSHIBA products specifications. Also, please keep in mind the precautions and conditions set forth in the "Handling Guide for Semiconductor Devices," or "TOSHIBA Semiconductor Reliability Handbook" etc..
- The TOSHIBA products listed in this document are intended for usage in general electronics applications (computer, personal equipment, office equipment, measuring equipment, industrial robotics, domestic appliances, etc.). These TOSHIBA products are neither intended nor warranted for usage in equipment that requires extraordinarily high quality and/or reliability or a malfunction or failure of which may cause loss of human life or bodily injury ("Unintended Usage"). Unintended Usage include atomic energy control instruments, airplane or spaceship instruments, transportation instruments, traffic signal instruments, combustion control instruments, medical instruments, all types of safety devices, etc.. Unintended Usage of TOSHIBA products listed in this document shall be made at the customer's own risk.
- The products described in this document are subject to the foreign exchange and foreign trade laws.
- The information contained herein is presented only as a guide for the applications of our products. No responsibility is assumed by TOSHIBA CORPORATION for any infringements of intellectual property or other rights of the third parties which may result from its use. No license is granted by implication or otherwise under any intellectual property or other rights of TOSHIBA CORPORATION or others.
- The information contained herein is subject to change without notice.