



LIGITEK

LIGITEK ELECTRONICS CO.,LTD.
Property of Ligitek Only

TAPE AND BOX TYPE LED LAMPS



Lead-Free Parts

LVG13743/P1-PF/TBS-X

DATA SHEET

DOC. NO : QW0905-LVG13743/P1-PF/TBS-X

REV : A

DATE : 14 - Apr. - 2006



Package Dimensions

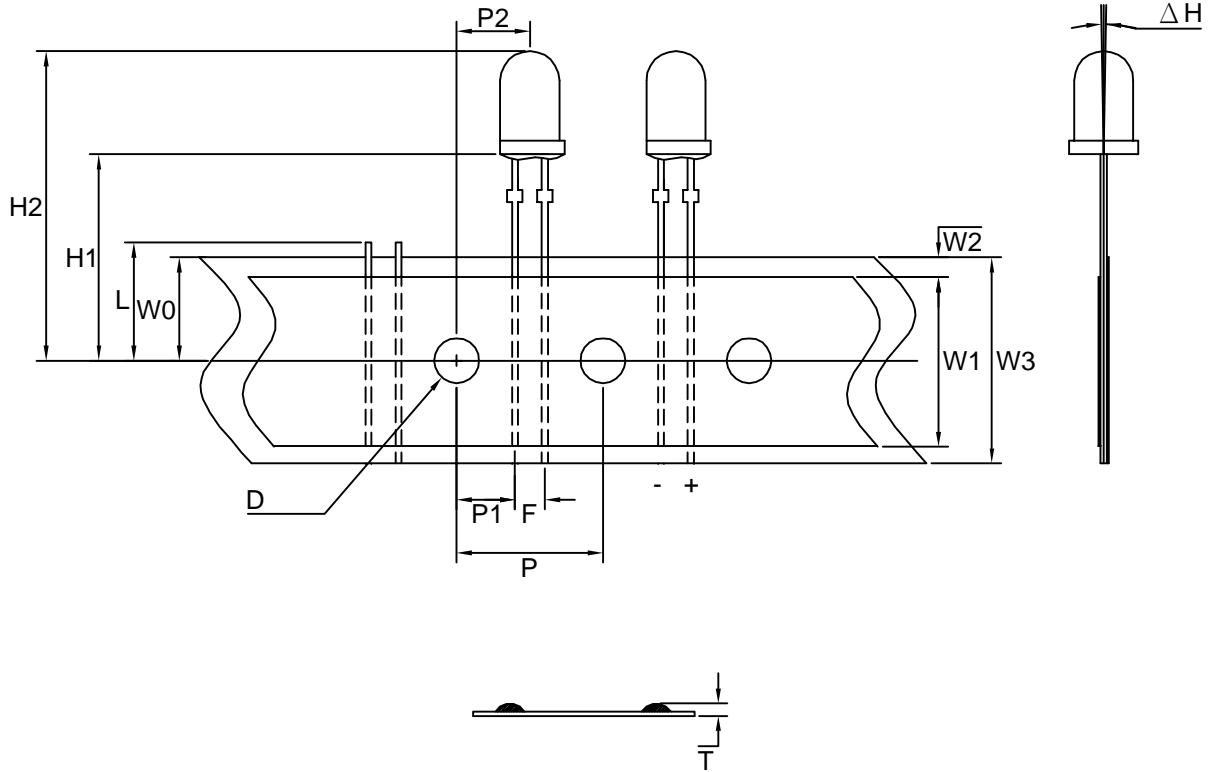

LVG13743/P1-PF

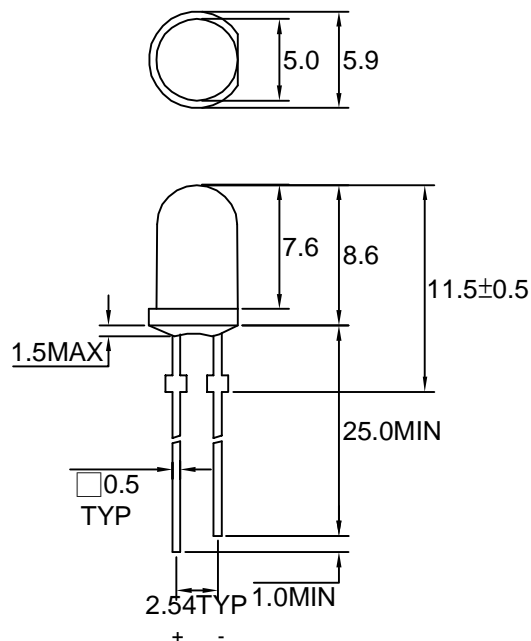

Note : 1.All dimension are in millimeter tolerance is ± 0.25 mm unless otherwise noted.
2.Specifications are subject to change without notice.

**Absolute Maximum Ratings at Ta=25 °C**

Parameter	Symbol	Ratings	UNIT
		VG	
Forward Current	IF	30	mA
Peak Forward Current Duty 1/10@10KHz	IFP	120	mA
Power Dissipation	PD	100	mW
Reverse Current @5V	Ir	10	μA
Operating Temperature	Topr	-40 ~ +85	°C
Storage Temperature	Tstg	-40 ~ +100	°C

Typical Electrical & Optical Characteristics (Ta=25 °C)

PART NO	MATERIAL	COLOR		Peak wave length λ Pnm	Spectral halfwidth Δ λ nm	Forward voltage @20mA(V)		Luminous intensity @20mA(mcd)		Viewing angle 2θ 1/2 (deg)
		Emitted	Lens			Min.	Max.	Min.	Typ.	
LVG13743/P1-PF/TBS-X	GaP	Green	Water Clear	565	30	1.7	2.6	50	90	56

Note : 1.The forward voltage data did not including ±0.1V testing tolerance.
2. The luminous intensity data did not including ±15% testing tolerance.



LIGITEK

LIGITEK ELECTRONICS CO.,LTD.

Property of Ligitek Only

PART NO. LVG13743/P1-PF/TBS-X

Page 3/6

• Dimension Symbol Information

SYMBOL ITEMS	OPTION CODE	SYMBOL	SPECIFICATIONS			
			Minimum		Maximum	
			mm	inch	mm	inch
Tape Feed Hole Diameter	-----	D	3.8	0.15	4.2	0.17
Component Lead Pitch	-----	F	2.3	0.09	3.0	0.12
Front-To-Rear Deflection	-----	ΔH	-----	-----	2.0	0.08
Feed Hole To Bottom Of Component	TBS-1	H1	17.5	0.69	18.5	0.73
	TBS-2		21.5	0.85	22.5	0.89
	TBS-3		25.5	1.0	26.5	1.04
	TBS-5		22.5	0.89	23.5	0.93
	TBS-6		19.9	0.78	20.9	0.82
	TBS-7		24.0	0.94	25.0	0.98
	TBS-8		24.5	0.96	25.5	1.0
	TBS-9		19.0	0.75	20.0	0.79
	TBS-10		18.4	0.72	19.4	0.76
	TBS-11		21.0	0.83	22.0	0.87
	TBS-12		20.5	0.81	21.5	0.85
	TBS-13		18.0	0.71	19.0	0.75
	Feed Hole To Overall Component Height		-----	H2	-----	-----
Lead Length After Component Height	-----	L	W0		11	0.43
Feed Hole Pitch	-----	P	12.4	0.49	13	0.51
Lead Location	-----	P1	4.4	0.17	5.8	0.23
Center Of Component Location	-----	P2	5.1	0.2	7.7	0.3
Overall Taped Package Thickness	-----	T	-----	-----	1.42	0.06
Feed Hole Location	-----	W0	8.5	0.33	9.75	0.38
Adhesive Tape Width	-----	W1	14.5	0.57	15.5	0.61
Adhesive Tape Position	-----	W2	0	0	4.0	0.16
Tape Width	-----	W3	17.5	0.69	19	0.75

REMARK:TBS=Tape And Box Straight Leads

• Dimensions Symbol Information

• Package Dimensions

Description	Symbol	Specification			
		minimum		maximum	
		mm	inch	mm	inch
Overall Length	L	330	13.0	340	13.4
Overall Width	W	265	10.4	275	10.8
Overall Thickness	H	50	1.97	60	2.4
Quantity/Box	2000PCS				

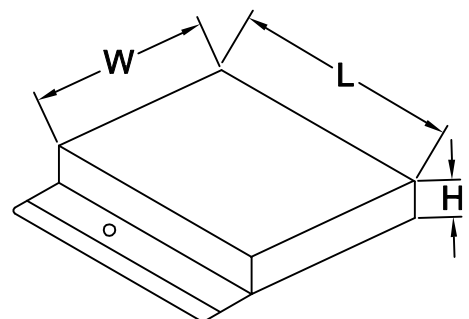



Typical Electro-Optical Characteristics Curve

VG CHIP

Fig.1 Forward current vs. Forward Voltage

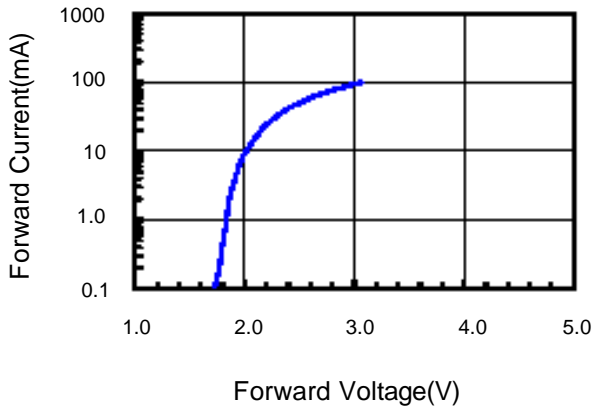

Fig.2 Relative Intensity vs. Forward Current

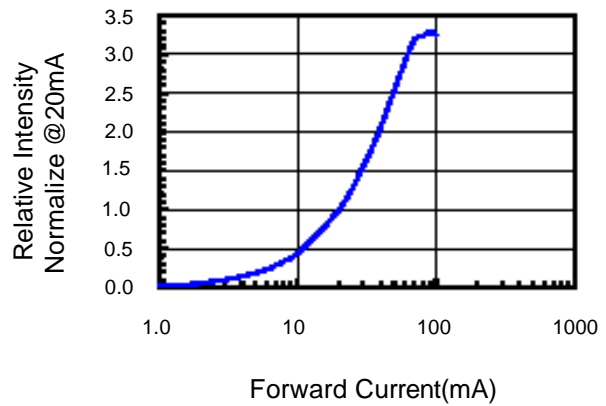

Fig.3 Forward Voltage vs. Temperature

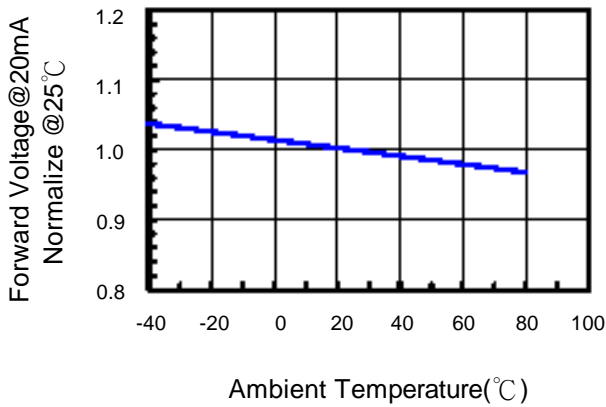

Fig.4 Relative Intensity vs. Temperature

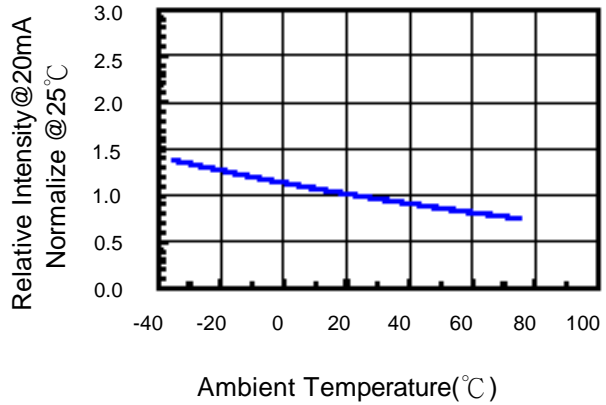

Fig.5 Relative Intensity vs. Wavelength

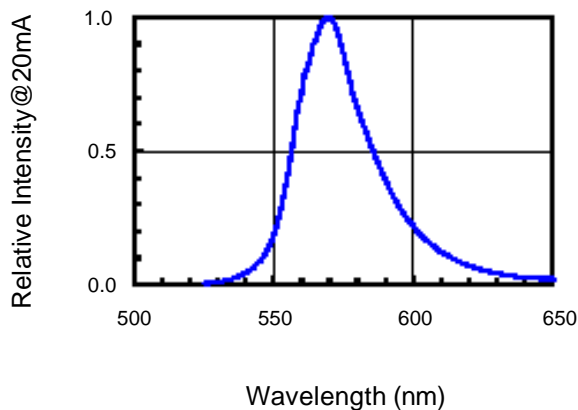
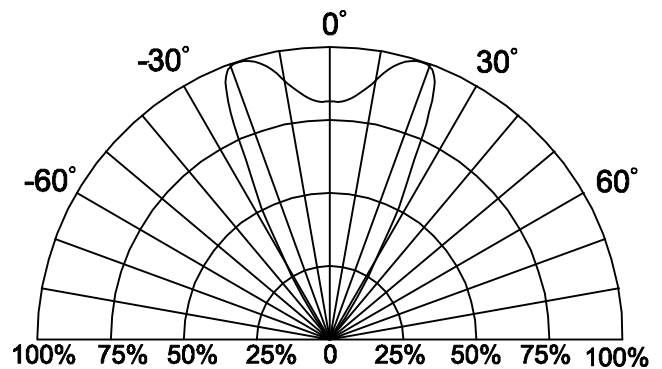

Fig.6 Directivity Radiation





Soldering Condition(Pb-Free)

1.Iron:

- Soldering Iron:30W Max
- Temperature 350 ° C Max
- Soldering Time:3 Seconds Max(One Time)
- Distance:2mm Min(From solder joint to body)

2.Wave Soldering Profile

- Dip Soldering
- Preheat: 120° C Max
- Preheat time: 60seconds Max
- Ramp-up
- 2° C/sec(max)
- Ramp-Down:-5° C/sec(max)
- Solder Bath:260° C Max
- Dipping Time:3 seconds Max
- Distance:2mm Min(From solder joint to body)

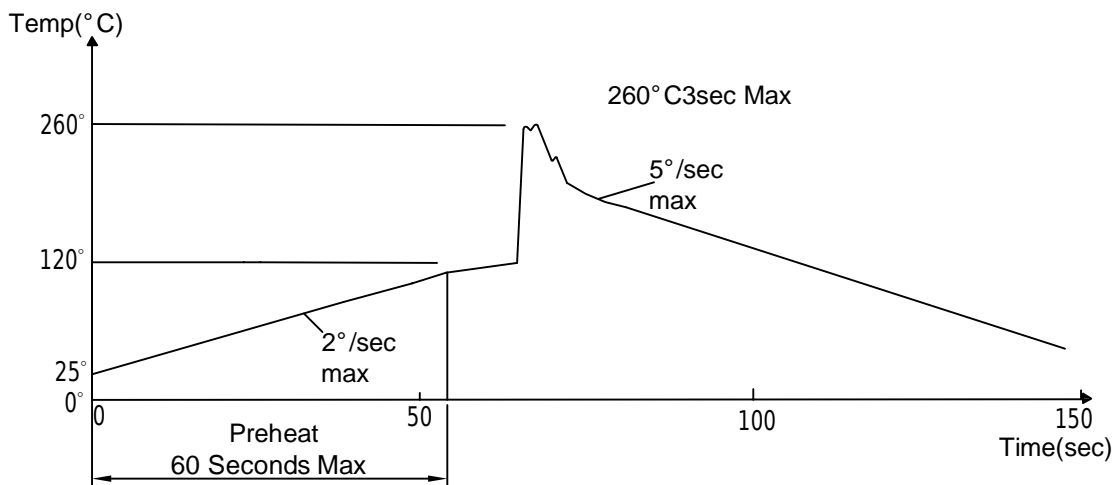



Reliability Test:

Test Item	Test Condition	Description	Reference Standard
Operating Life Test	1.Under Room Temperature 2.If=20mA 3.t=1000 hrs (-24hrs, +72hrs)	This test is conducted for the purpose of determining the resistance of a part in electrical and thermal stressed.	MIL-STD-750: 1026 MIL-STD-883: 1005 JIS C 7021: B-1
High Temperature Storage Test	1.Ta=105°C±5°C 2.t=1000 hrs (-24hrs, +72hrs)	The purpose of this is the resistance of the device which is laid under condition of high temperature for hours.	MIL-STD-883:1008 JIS C 7021: B-10
Low Temperature Storage Test	1.Ta=-40°C±5°C 2.t=1000 hrs (-24hrs, +72hrs)	The purpose of this is the resistance of the device which is laid under condition of low temperature for hours.	JIS C 7021: B-12
High Temperature High Humidity Test	1.Ta=65°C±5°C 2.RH=90%~95% 3.t=240hrs±2hrs	The purpose of this test is the resistance of the device under tropical for hours.	MIL-STD-202:103B JIS C 7021: B-11
Thermal Shock Test	1.Ta=105°C±5°C & -40°C±5°C (10min) (10min) 2.total 10 cycles	The purpose of this is the resistance of the device to sudden extreme changes in high and low temperature.	MIL-STD-202: 107D MIL-STD-750: 1051 MIL-STD-883: 1011
Solder Resistance Test	1.T.Sol=260°C±5°C 2.Dwell time= 10±1sec.	This test intended to determine the thermal characteristic resistance of the device to sudden exposures at extreme changes in temperature when soldering the lead wire.	MIL-STD-202: 210A MIL-STD-750: 2031 JIS C 7021: A-1
Solderability Test	1.T.Sol=230°C±5°C 2.Dwell time=5±1sec	This test intended to see soldering well performed or not.	MIL-STD-202: 208D MIL-STD-750: 2026 MIL-STD-883: 2003 JIS C 7021: A-2