



N-Channel 60-V (D-S) Single and Quad MOSFETs

PRODUCT SUMMARY				
Part Number	V _{(BR)DSS} Min (V)	r _{DS(on)} Max (Ω)	V _{GS(th)} (V)	I _D (A)
2N6660	60	3 @ V _{GS} = 10 V	0.8 to 2	1.1
VQ1004J/P		3.5 @ V _{GS} = 10 V	0.8 to 2.5	0.46

FEATURES

- Low On-Resistance: 1.3 Ω
- Low Threshold: 1.7 V
- Low Input Capacitance: 35 pF
- Fast Switching Speed: 8 ns
- Low Input and Output Leakage

BENEFITS

- Low Offset Voltage
- Low-Voltage Operation
- Easily Driven Without Buffer
- High-Speed Circuits
- Low Error Voltage

APPLICATIONS

- Direct Logic-Level Interface: TTL/CMOS
- Drivers: Relays, Solenoids, Lamps, Hammers, Displays, Memories, Transistors, etc.
- Battery Operated Systems
- Solid-State Relays

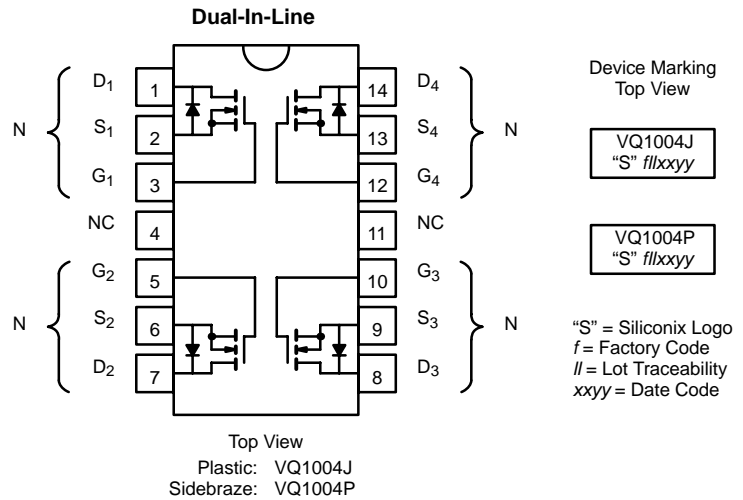
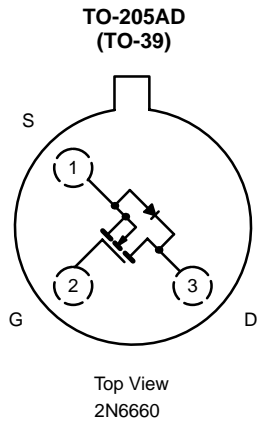

ABSOLUTE MAXIMUM RATINGS (T_A = 25 °C UNLESS OTHERWISE NOTED)

Parameter	Symbol	2N6660	Single		Total Quad	Unit	
			VQ1004J	VQ1004P	VQ1004J/P		
Drain-Source Voltage	V _{DS}	60	60	60		V	
Gate-Source Voltage	V _{GS}	±20	±30	±20			
Continuous Drain Current (T _J = 150 °C)	I _D	T _C = 25 °C	1.1	0.46	±0.46	A	
		T _C = 100 °C	0.8	0.26	0.26		
Pulsed Drain Current ^a	I _{DM}	3	2	2			
Power Dissipation	P _D	T _C = 25 °C	6.25	1.3	1.3	2	W
		T _C = 100 °C	2.5	0.52	0.52	0.8	
Thermal Resistance, Junction-to-Ambient ^b	R _{thJA}	170	0.96	0.96	62.5	°C/W	
Thermal Resistance, Junction-to-Case	R _{thJC}	20					
Operating Junction and Storage Temperature Range	T _J , T _{stg}	-55 to 150				°C	

Notes
a. Pulse width limited by maximum junction temperature.
b. This parameter not registered with JEDEC.

SPECIFICATIONS ($T_A = 25^\circ\text{C}$ UNLESS OTHERWISE NOTED)									
Parameter	Symbol	Test Conditions	Typ ^a	Limits				Unit	
				2N6660		VQ1004J/P			
				Min	Max	Min	Max		
Static									
Drain-Source Breakdown Voltage	$V_{(BR)DSS}$	$V_{GS} = 0\text{ V}, I_D = 10\ \mu\text{A}$	75	60		60		V	
Gate-Threshold Voltage	$V_{GS(th)}$	$V_{DS} = V_{GS}, I_D = 1\text{ mA}$	1.7	0.8	2	0.8	2.5		
Gate-Body Leakage	I_{GSS}	$V_{DS} = 0\text{ V}, V_{GS} = \pm 15\text{ V}$ $T_C = 125^\circ\text{C}$			± 100		± 100	nA	
					± 500		± 500		
Zero Gate Voltage Drain Current	I_{DSS}	$V_{DS} = 60\text{ V}, V_{GS} = 0\text{ V}$ $V_{DS} = 35\text{ V}, V_{GS} = 0\text{ V}$ $V_{DS} = 48\text{ V}, V_{GS} = 0\text{ V}$ $T_C = 125^\circ\text{C}$ $V_{DS} = 28\text{ V}, V_{GS} = 0\text{ V}$ $T_C = 125^\circ\text{C}$			10			μA	
						500			500
On-State Drain Current ^b	$I_{D(on)}$	$V_{DS} = 10\text{ V}, V_{GS} = 10\text{ V}$	3	1.5		1.5		A	
Drain-Source On-Resistance ^b	$r_{DS(on)}$	$V_{GS} = 5\text{ V}, I_D = 0.3\text{ A}^d$ $V_{GS} = 10\text{ V}, I_D = 1\text{ A}$ $T_C = 125^\circ\text{C}^d$	2		5		5	Ω	
			1.3		3		3.5		
			2.4		4.2		4.9		
Forward Transconductance ^b	g_{fs}	$V_{DS} = 10\text{ V}, I_D = 0.5\text{ A}$	350	170		170		mS	
Common Source Output Conductance ^b	g_{os}	$V_{DS} = 10\text{ V}, I_D = 0.1\text{ A}$	1						
Diode Forward Voltage	V_{SD}	$I_S = 0.99\text{ A}, V_{GS} = 0\text{ V}$	0.8					V	
Dynamic									
Input Capacitance	C_{iss}	$V_{DS} = 24\text{ V}, V_{GS} = 0\text{ V}$ $f = 1\text{ MHz}$	35		50		60	pF	
Output Capacitance	C_{oss}		25		40		50		
Reverse Transfer Capacitance	C_{rss}		7		10		10		
Drain-Source Capacitance	C_{ds}		30		40				
Switching^c									
Turn-On Time	t_{ON}	$V_{DD} = 25\text{ V}, R_L = 23\ \Omega$ $I_D \cong 1\text{ A}, V_{GEN} = 10\text{ V}$ $R_G = 25\ \Omega$	8		10		10	ns	
Turn-Off Time	t_{OFF}		8.5		10		10		

Notes

- For DESIGN AID ONLY, not subject to production testing.
- Pulse test: $PW \leq 80\ \mu\text{s}$ duty cycle $\leq 1\%$.
- Switching time is essentially independent of operating temperature.
- This parameter not registered with JEDEC on 2N6660.

VNDQ06



TYPICAL CHARACTERISTICS ($T_A = 25^\circ\text{C}$ UNLESS OTHERWISE NOTED)

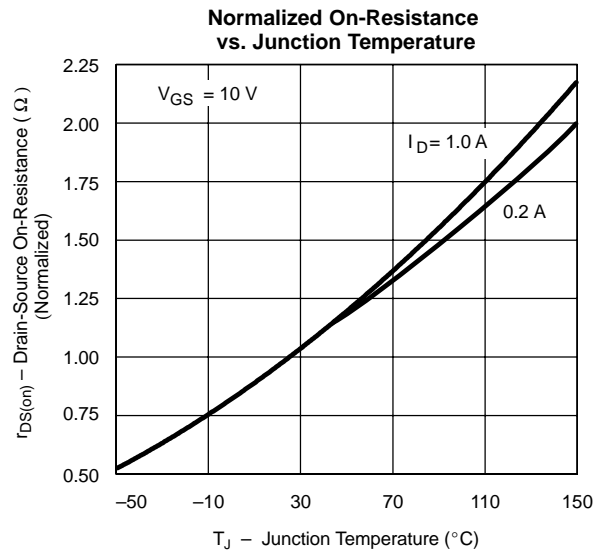
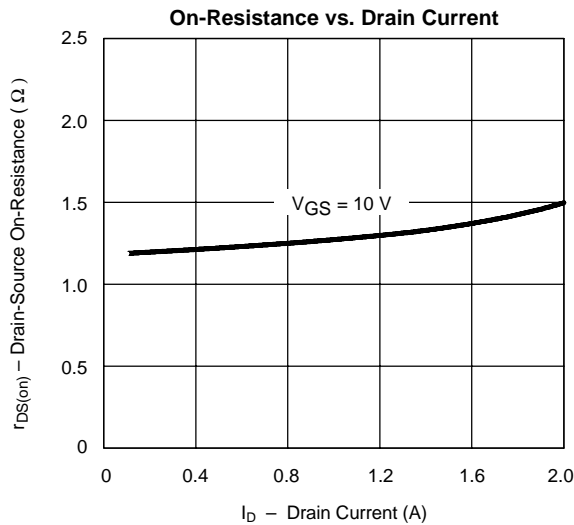
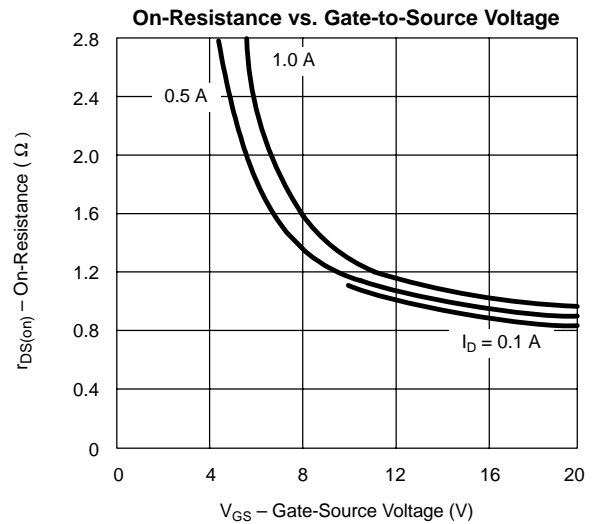
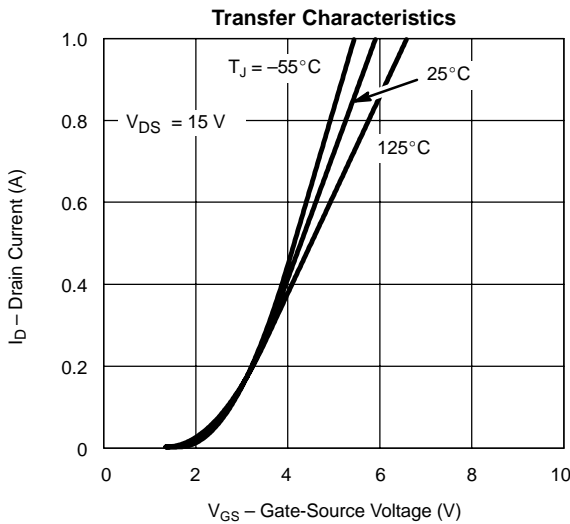
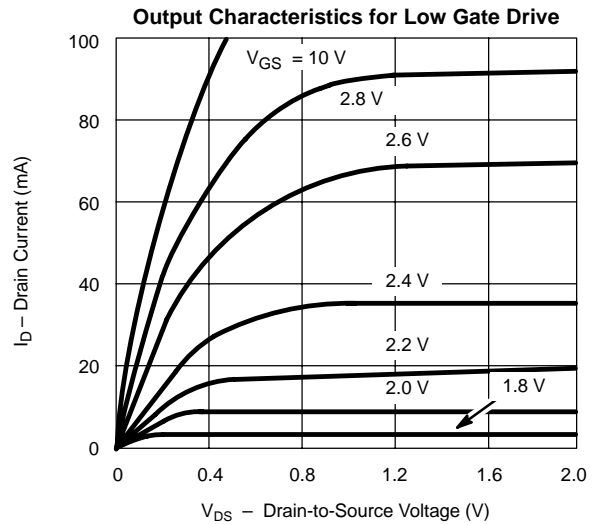
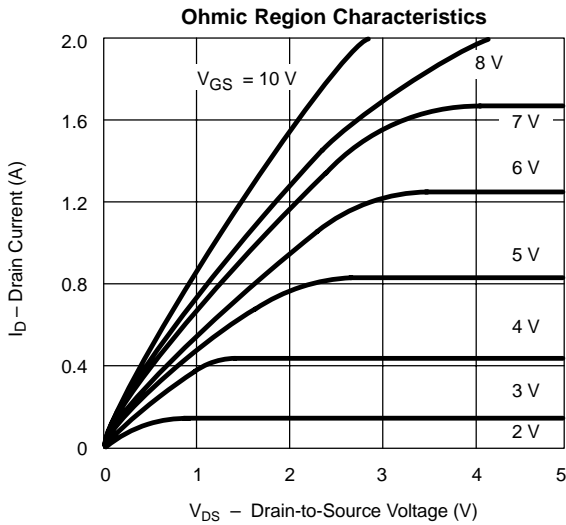

TYPICAL CHARACTERISTICS ($T_A = 25^\circ\text{C}$ UNLESS OTHERWISE NOTED)

