

Continuous-Time Ratiometric Linear Hall Effect Sensors

Features and Benefits

- Low-noise output
- Fast power-on time
- Ratiometric rail-to-rail output
- 4.5 to 6.0 V operation
- Solid-state reliability
- Factory-programmed at end-of-line for optimum performance
- Robust ESD performance

Packages: 3 pin SOT23W (suffix LH), and 3 pin SIP (suffix UA)



Not to scale

Description

The A1301 and A1302 are continuous-time, ratiometric, linear Hall-effect sensors. They are optimized to accurately provide a voltage output that is proportional to an applied magnetic field. These devices have a quiescent output voltage that is 50% of the supply voltage. Two output sensitivity options are provided: 2.5 mV/G typical for the A1301, and 1.3 mV/G typical for the A1302.

The Hall-effect integrated circuit included in each device includes a Hall sensing element, a linear amplifier, and a CMOS Class A output structure. Integrating the Hall sensing element and the amplifier on a single chip minimizes many of the problems normally associated with low voltage level analog signals.

High precision in output levels is obtained by internal gain and offset trim adjustments made at end-of-line during the manufacturing process.

These features make the A1301 and A1302 ideal for use in position sensing systems, for both linear target motion and rotational target motion. They are well-suited for industrial applications over extended temperature ranges, from -40°C to 125°C .

Two device package types are available: LH, a 3-pin SOT23W type for surface mount, and UA, a 3-pin ultramini SIP for through-hole mount. They are lead (Pb) free (suffix, $-T$) with 100% matte tin plated leadframes.

Functional Block Diagram

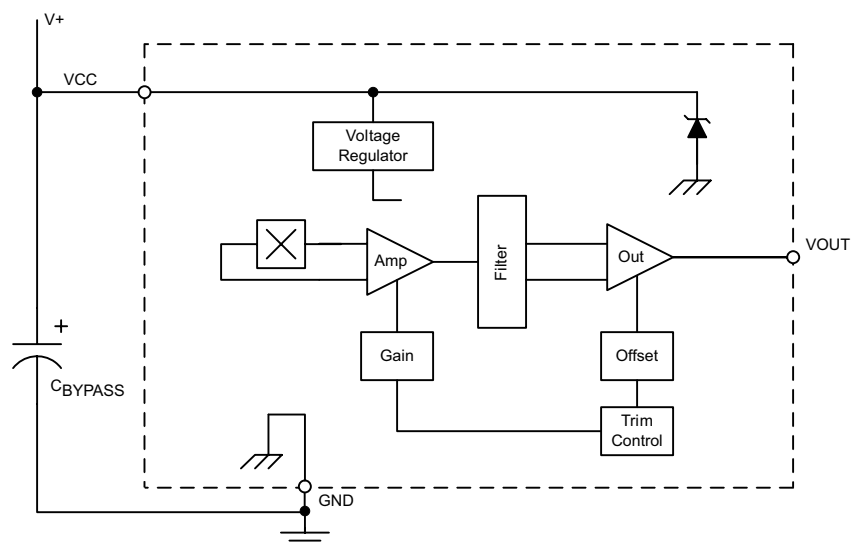

Selection Guide

Part Number	Pb-free ¹	Packing ²	Package	Ambient, T _A	Sensitivity (Typical)
A1301ELHLT-T	Yes	7-in. tape and reel, 3000 pieces/reel	Surface Mount	-40°C to 85°C	2.5 mV/G
A1301EUA-T	Yes	Bulk, 500 pieces/bag	SIP		
A1301KLHLT-T	Yes	7-in. tape and reel, 3000 pieces/reel	Surface Mount	-40°C to 125°C	
A1301KUA-T	Yes	Bulk, 500 pieces/bag	SIP		
A1302ELHLT-T	Yes	7-in. tape and reel, 3000 pieces/reel	Surface Mount	-40°C to 85°C	1.3 mV/G
A1302EUA-T	Yes	Bulk, 500 pieces/bag	SIP		
A1302KLHLT-T	Yes	7-in. tape and reel, 3000 pieces/reel	Surface Mount	-40°C to 125°C	
A1302KUA-T	Yes	Bulk, 500 pieces/bag	SIP		

¹Pb-based variants are being phased out of the product line. Certain variants cited in this footnote are no longer in production. The variants should not be purchased for new design applications. Samples are no longer available. Status change: May 1, 2006. These variants include: A1301ELHLT, A1301EUA, A1301KLHLT, A1301KUA, A1302ELHLT, A1302EUA, A1302KLHLT, and A1302KUA.

²Contact Allegro for additional packing options.



Absolute Maximum Ratings

Characteristic	Symbol	Notes	Rating	Units
Supply Voltage	V _{CC}		8	V
Output Voltage	V _{OUT}		8	V
Reverse Supply Voltage	V _{RCC}		-0.1	V
Reverse Supply Voltage	V _{RCC}		-0.1	V
Output Sink Current	I _{OUT}		10	mA
Operating Ambient Temperature	T _A	Range E	-40 to 85	°C
		Range K	-40 to 125	°C
Maximum Junction Temperature	T _{J(max)}		165	°C
Storage Temperature	T _{stg}		-65 to 170	°C

DEVICE CHARACTERISTICS over operating temperature range, T_A , and $V_{CC} = 5\text{ V}$, unless otherwise noted

Characteristic	Symbol	Test Conditions	Min.	Typ.	Max.	Units
Electrical Characteristics						
Supply Voltage	V_{CC}	Running, $T_J < 165^\circ\text{C}$	4.5	–	6	V
Supply Current	I_{CC}	Output open	–	–	11	mA
Output Voltage	$V_{OUT(High)}$	$I_{SOURCE} = -1\text{ mA}$, Sens = nominal	4.65	4.7	–	V
	$V_{OUT(Low)}$	$I_{SINK} = 1\text{ mA}$, Sens = nominal	–	0.2	0.25	V
Output Bandwidth	BW		–	20	–	kHz
Power-On Time	t_{PO}	$V_{CC(min)}$ to $0.95 V_{OUT}$; $B = \pm 1400\text{ G}$; Slew rate = $4.5\text{ V}/\mu\text{s}$ to $4.5\text{ V}/100\text{ ns}$	–	3	5	μs
Output Resistance	R_{OUT}	$I_{SINK} \leq 1\text{ mA}$, $I_{SOURCE} \geq -1\text{ mA}$	–	2	5	Ω
Wide Band Output Noise, rms	V_{OUTN}	External output low pass filter $\leq 10\text{ kHz}$; Sens = nominal	–	150	–	μV
Ratiometry						
Quiescent Output Voltage Error with respect to ΔV_{CC} ¹	$\Delta V_{OUTQ(V)}$	$T_A = 25^\circ\text{C}$	–	–	± 3.0	%
Magnetic Sensitivity Error with respect to ΔV_{CC} ²	$\Delta \text{Sens}_{(V)}$	$T_A = 25^\circ\text{C}$	–	–	± 3.0	%
Output						
Linearity	Lin	$T_A = 25^\circ\text{C}$	–	–	± 2.5	%
Symmetry	Sym	$T_A = 25^\circ\text{C}$	–	–	± 3.0	%
Magnetic Characteristics						
Quiescent Output Voltage	V_{OUTQ}	$B = 0\text{ G}$; $T_A = 25^\circ\text{C}$	2.4	2.5	2.6	V
Quiescent Output Voltage over Operating Temperature Range	$V_{OUTQ(\Delta T_A)}$	$B = 0\text{ G}$	2.2	–	2.8	V
Magnetic Sensitivity	Sens	A1301; $T_A = 25^\circ\text{C}$	2.0	2.5	3.0	mV/G
		A1302; $T_A = 25^\circ\text{C}$	1.0	1.3	1.6	mV/G
Magnetic Sensitivity over Operating Temperature Range	$\text{Sens}_{(\Delta T_A)}$	A1301	1.8	–	3.2	mV/G
		A1302	0.85	–	1.75	mV/G

¹Refer to equation (4) in Ratiometric section on page 4.

²Refer to equation (5) in Ratiometric section on page 4.

Characteristic Definitions

Quiescent Output Voltage. In the quiescent state (no significant magnetic field: $B = 0$), the output, V_{OUTQ} , equals one half of the supply voltage, V_{CC} , throughout the entire operating ranges of V_{CC} and ambient temperature, T_A . Due to internal component tolerances and thermal considerations, there is a tolerance on the quiescent output voltage, ΔV_{OUTQ} , which is a function of both ΔV_{CC} and ΔT_A . For purposes of specification, the quiescent output voltage as a function of temperature, $\Delta V_{OUTQ(\Delta T_A)}$, is defined as:

$$\Delta V_{OUTQ(\Delta T_A)} = \frac{V_{OUTQ(T_A)} - V_{OUTQ(25^\circ C)}}{Sens_{(25^\circ C)}} \quad (1)$$

where $Sens$ is in mV/G, and the result is the device equivalent accuracy, in gauss (G), applicable over the entire operating temperature range.

Sensitivity. The presence of a south-polarity (+B) magnetic field, perpendicular to the branded face of the device package, increases the output voltage, V_{OUT} , in proportion to the magnetic field applied, from V_{OUTQ} toward the V_{CC} rail. Conversely, the application of a north polarity (-B) magnetic field, in the same orientation, proportionally decreases the output voltage from its quiescent value. This proportionality is specified as the magnetic sensitivity of the device and is defined as:

$$Sens = \frac{V_{OUT(-B)} - V_{OUT(+B)}}{2B} \quad (2)$$

The stability of the device magnetic sensitivity as a function of ambient temperature, $\Delta Sens_{(\Delta T_A)}$ (%) is defined as:

$$\Delta Sens_{(\Delta T_A)} = \frac{Sens_{(T_A)} - Sens_{(25^\circ C)}}{Sens_{(25^\circ C)}} \times 100\% \quad (3)$$

Ratiometric. The A1301 and A1302 feature a ratiometric output. This means that the quiescent voltage output, V_{OUTQ} , and the magnetic sensitivity, $Sens$, are proportional to the supply voltage, V_{CC} .

The ratiometric change (%) in the quiescent voltage output is defined as:

$$\Delta V_{OUTQ(\Delta V)} = \frac{V_{OUTQ(V_{CC})} / V_{OUTQ(5V)}}{V_{CC} / 5V} \times 100\% \quad (4)$$

and the ratiometric change (%) in sensitivity is defined as:

$$\Delta Sens_{(\Delta V)} = \frac{Sens_{(V_{CC})} / Sens_{(5V)}}{V_{CC} / 5V} \times 100\% \quad (5)$$

Linearity and Symmetry. The on-chip output stage is designed to provide linear output at a supply voltage of 5 V. Although the application of very high magnetic fields does not damage these devices, it does force their output into a nonlinear region. Linearity in percent is measured and defined as:

$$Lin+ = \frac{V_{OUT(+B)} - V_{OUTQ}}{2(V_{OUT(+B/2)} - V_{OUTQ})} \times 100\% \quad (6)$$

$$Lin- = \frac{V_{OUT(-B)} - V_{OUTQ}}{2(V_{OUT(-B/2)} - V_{OUTQ})} \times 100\% \quad (7)$$

and output symmetry as:

$$Sym = \frac{V_{OUT(+B)} - V_{OUTQ}}{V_{OUTQ} - V_{OUT(-B)}} \times 100\% \quad (8)$$

Typical Characteristics
(30 pieces, 3 fabrication lots)

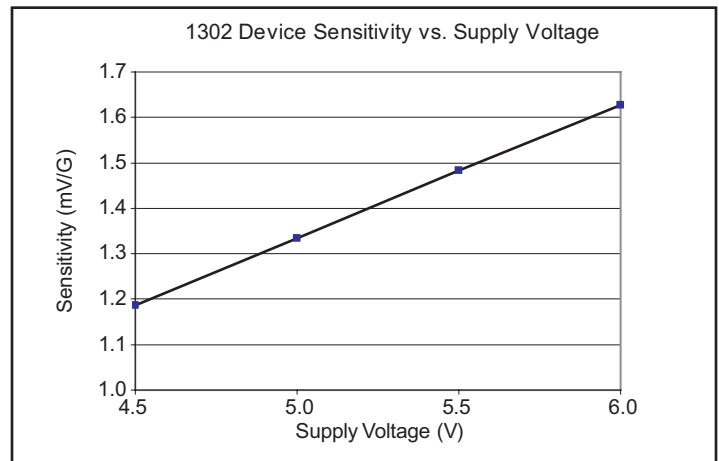
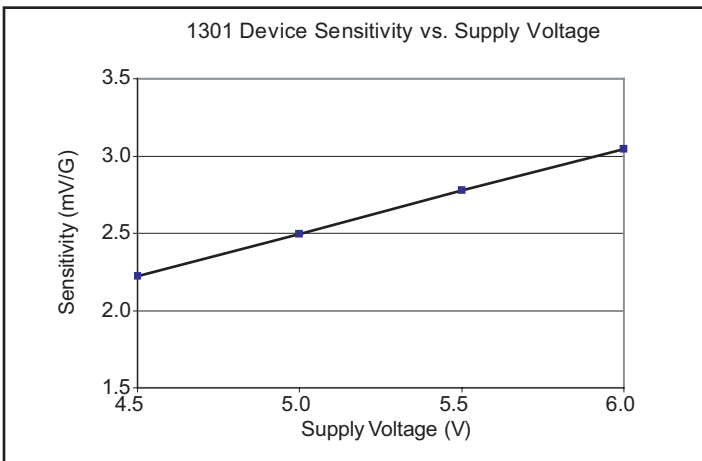
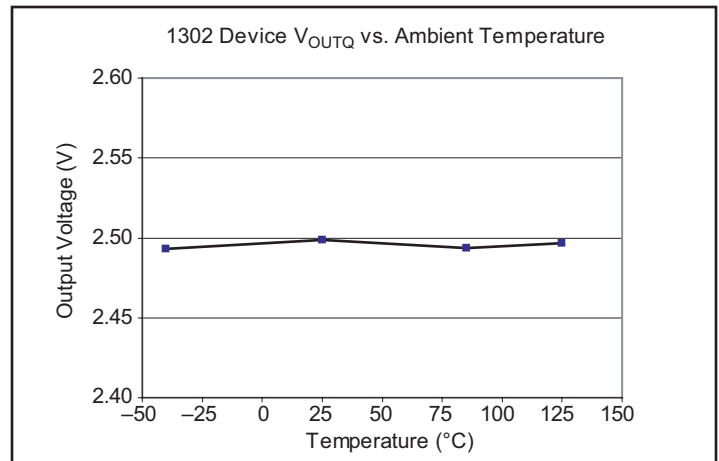
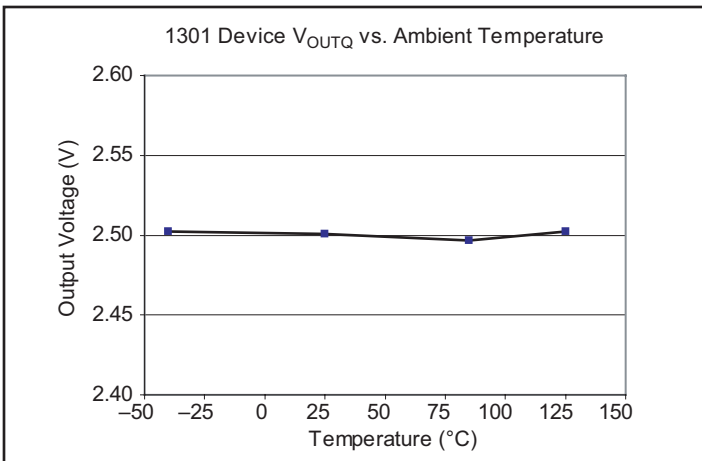
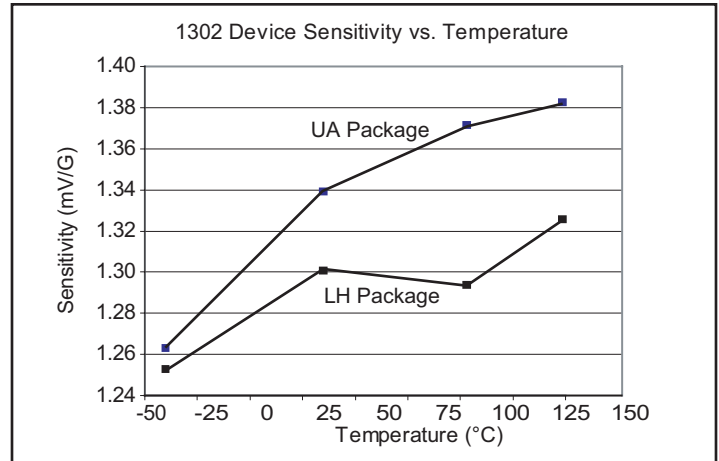
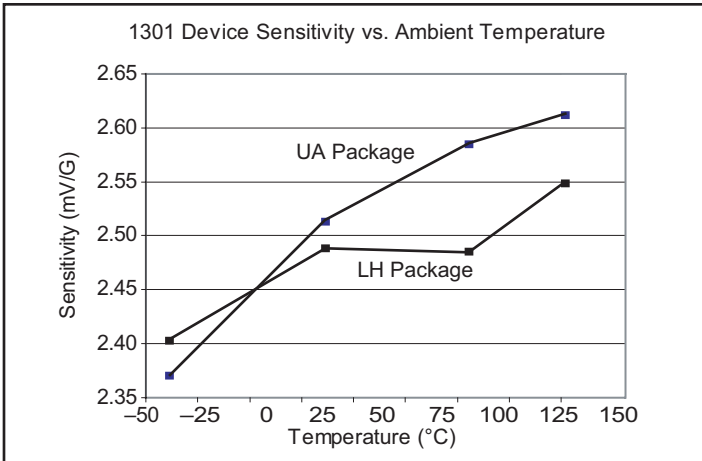

Continued on the next page...

Typical Characteristics, continued
(30 pieces, 3 fabrication lots)

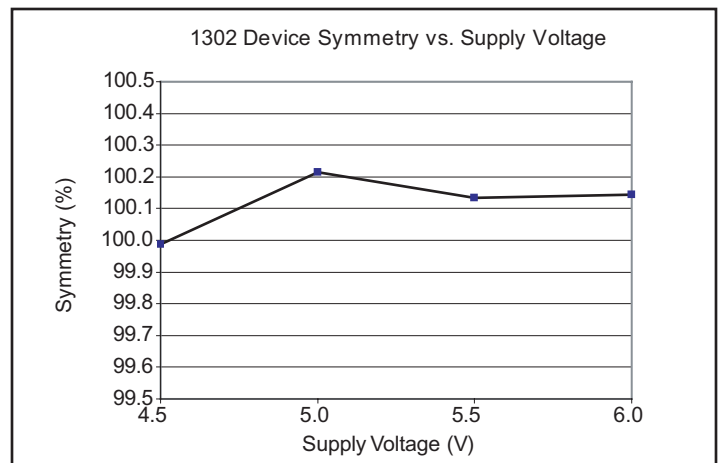
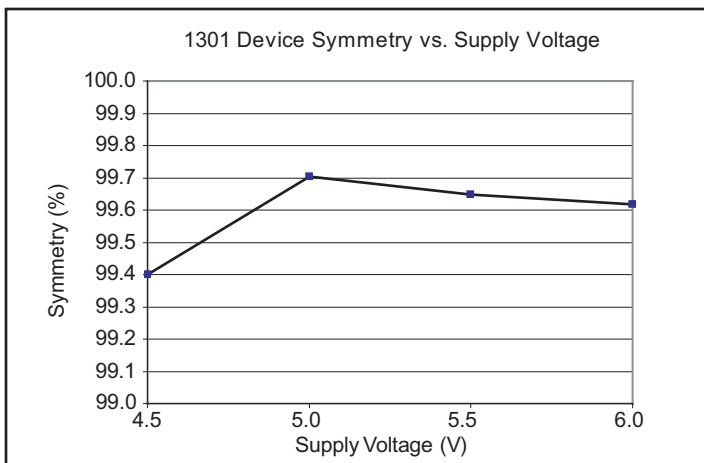
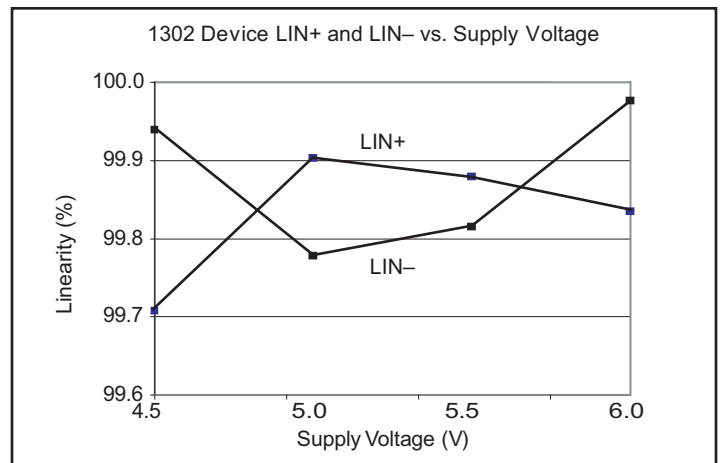
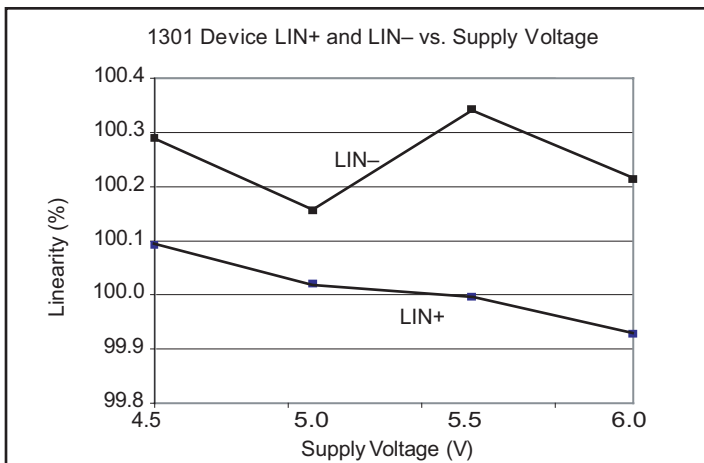
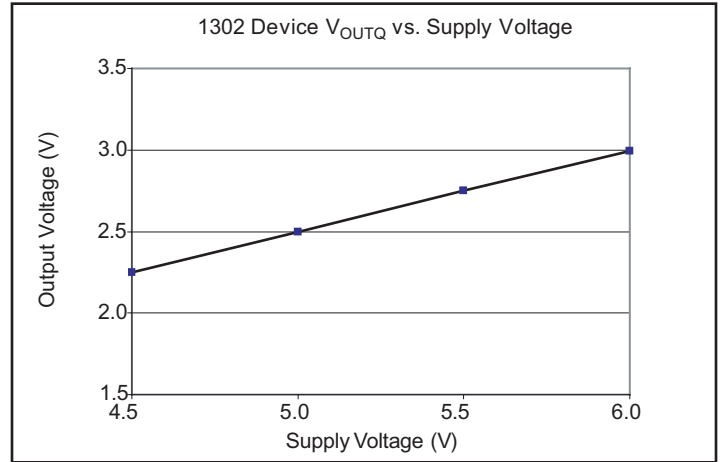
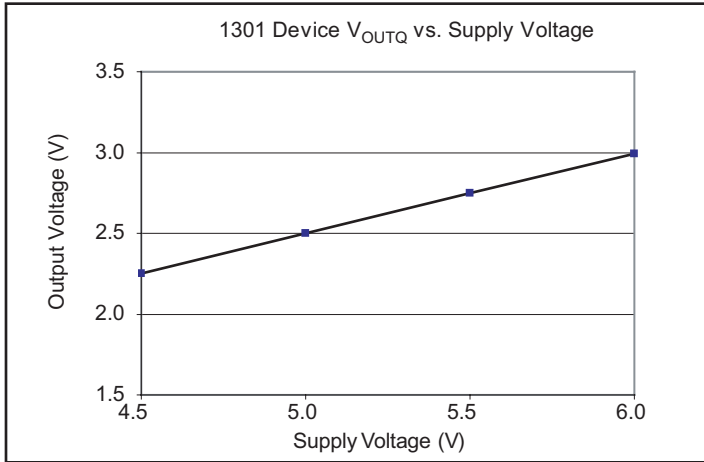

Package LH, 3-Pin; (SOT-23W)

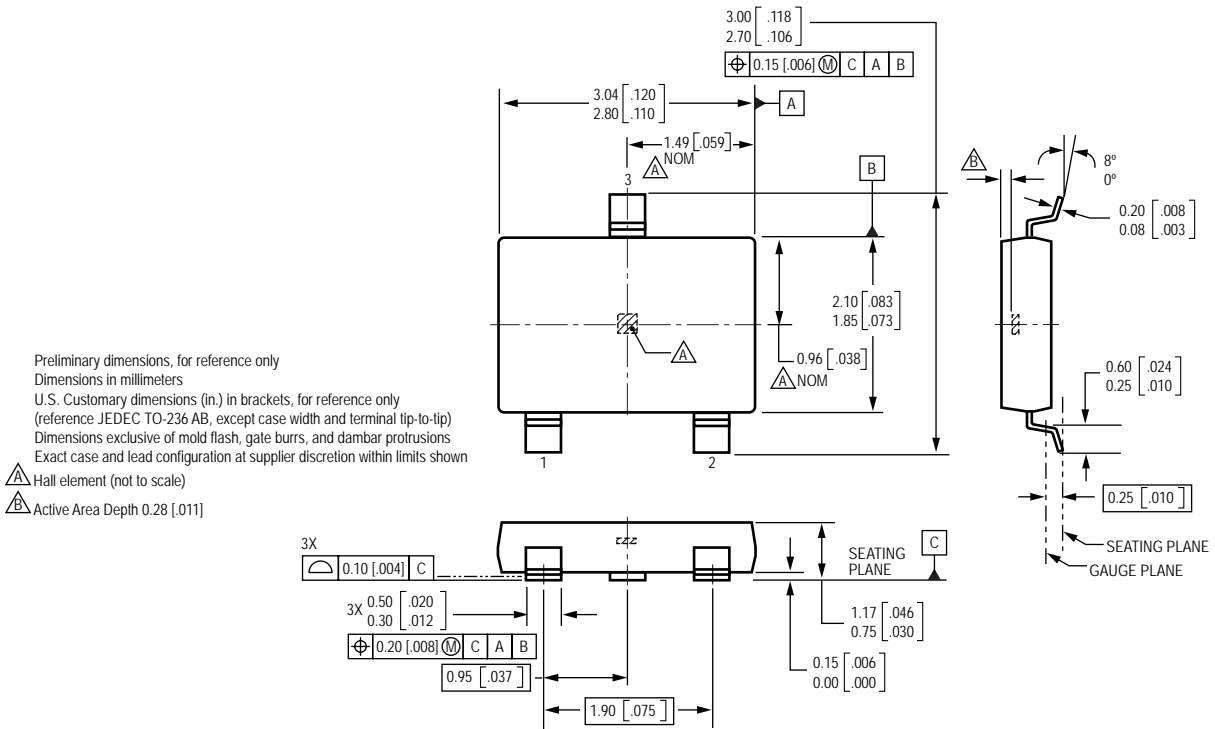

Pin-out Drawings

Package LH

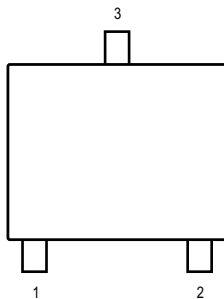

Package UA

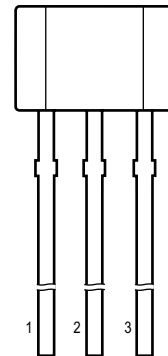

Terminal List

Symbol	Number		Description
	Package LH	Package UA	
VCC	1	1	Connects power supply to chip
VOUT	2	3	Output from circuit
GND	3	2	Ground

Package UA, 3-Pin SIP

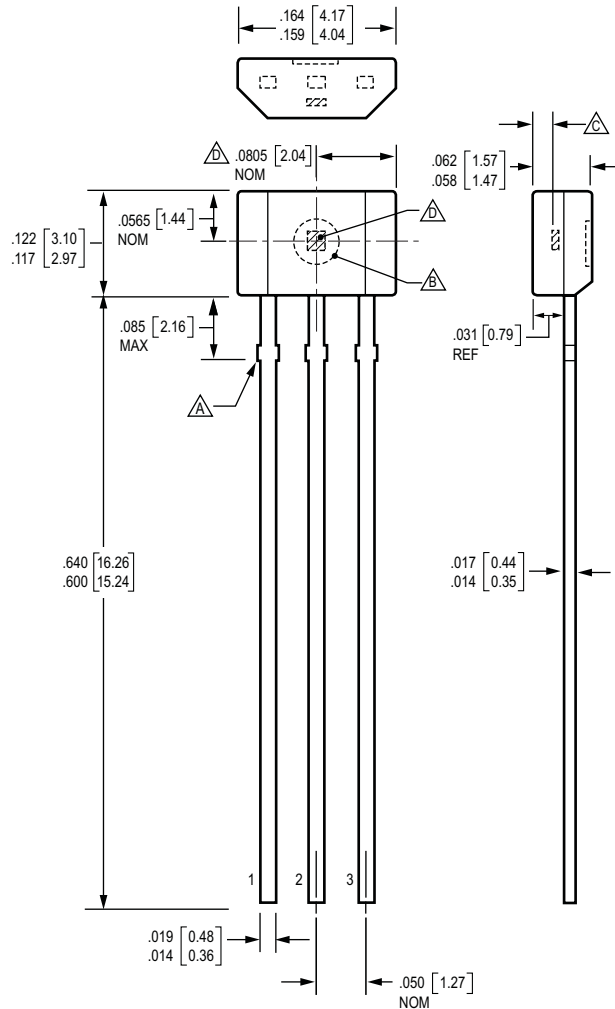

- Dimensions in inches
Metric dimensions (mm) in brackets, for reference only
- Dambar removal protrusion (6X)
 - Ejector mark on opposite side
 - Active Area Depth .0195 [0.50] NOM
 - Hall element (not to scale)

The products described herein are manufactured under one or more of the following U.S. patents: 5,045,920; 5,264,783; 5,442,283; 5,389,889; 5,581,179; 5,517,112; 5,619,137; 5,621,319; 5,650,719; 5,686,894; 5,694,038; 5,729,130; 5,917,320; and other patents pending.

Allegro MicroSystems, Inc. reserves the right to make, from time to time, such departures from the detail specifications as may be required to permit improvements in the performance, reliability, or manufacturability of its products. Before placing an order, the user is cautioned to verify that the information being relied upon is current.

Allegro products are not authorized for use as critical components in life-support devices or systems without express written approval.

The information included herein is believed to be accurate and reliable. However, Allegro MicroSystems, Inc. assumes no responsibility for its use; nor for any infringement of patents or other rights of third parties which may result from its use.

Copyright © 2005, 2006 Allegro MicroSystems, Inc.