

High-Speed (10Mbps), Fail-Safe, RS-485/RS-422 Transceivers with Slew-Rate-Limiting and $\pm 15\text{kV}$ ESD Protection



ADM3082/ADM3085/ADM3088

FEATURES

- Enhanced Slew Rate Limiting for Error-Free Data Transmission
- Fail-Safe Receiver Operation while Maintaining EIA/TIA-485 compatibility
- Low-Current (1nA) Shutdown Mode
- High Input Impedance — Up to 256 Transceivers on Bus
- $\pm 15\text{kV}$ ESD Protection (Human Body Model) on RS-485 I/O pins
- Pin-Compatible with Industry Standard 75176

APPLICATIONS

- Enhanced Replacement for Industry-Standard Parts
- EMI-Sensitive Systems
- Level Translation
- LANs for Industrial Control Applications

GENERAL DESCRIPTION

The ADM3082/ADM3085/ADM3088 are high-speed RS-485/RS-422 transceivers consisting of one driver and one receiver per package. The devices feature fail-safe operation, ensuring a logic-high receiver output when the receiver inputs are open-circuit or short-circuit. This guarantees that the receiver output will be high if all the transmitters on a terminated bus are disabled (high-impedance).

The ADM3082 has a slew-rate limited driver to minimize electromagnetic interference (EMI) and reduce reflections caused by incorrectly terminated cables. This allows error-free transmission at data rates up to 115kbps.

The ADM3085 offers a higher slew rate allowing data rates up to 500kbps, while the ADM3088 has a driver whose slew rate is not limited, allowing data rates up to 10Mbps.

All devices in the family feature $\pm 15\text{kV}$ electrostatic discharge (ESD) protection and high receiver input impedance (1/8 unit load), allowing up to 256 transceivers on the bus. The devices have low current drain of $375\mu\text{A}$ unloaded, or fully loaded with the drivers disabled, and feature an ultra-low power (1nA) shutdown mode.

FUNCTIONAL BLOCK DIAGRAM

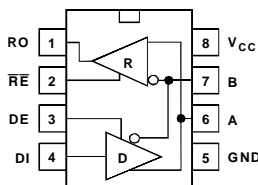

ADM3082/ADM3085/ADM3088

Information furnished by Analog Devices is believed to be accurate and reliable. However, no responsibility is assumed by Analog Devices for its use, nor for any infringements of patents or other rights of third parties which may result from its use. No license is granted by implication or otherwise under any patent or patent rights of Analog Devices.

One Technology Way, P.O. Box 9106, Norwood, MA 02062-9106, U.S.A.
Tel: 617/329-4700 World Wide Web Site: <http://www.analog.com>
Fax: 617/326-8703 © Analog Devices, Inc., 2002

PRELIMINARY TECHNICAL DATA

ADM3082/ADM3085/ADM3088

ADM3082/ADM3085/ADM3088 SPECIFICATIONS

DCELECTRICAL CHARACTERISTICS

($V_{CC} = +5V \pm 5\%$, $T_A = T_{MIN}$ to T_{MAX} , unless otherwise noted. Typical values are at $V_{CC} = +5V$ and $T_A = +25^\circ C$.) (Note 1)

DRIVER

Parameter	Min	Typ	Max	Units	Test Conditions/Comments
Differential Driver Output, V_{OD1}			5	V	Figure 1 (No Load)
Differential Driver Output, V_{OD2}	2.0 1.5			V V	Figure 1, R = 50 Ω (RS-422) Figure 1, R = 27 Ω (RS-485)
Change-in-Magnitude of Differential Common-Mode Output Voltage, ΔV_{OD}			0.2	V	Figure 1, R = 50 Ω or R = 27 Ω (Note 2)
Driver Common-Mode Output Voltage, V_{OC}			3	V	Figure 1, R = 50 Ω or R = 27 Ω
Change-in-Magnitude of Common-Mode Voltage, ΔV_{OC}			0.2	V	Figure 1, R = 50 Ω or R = 27 Ω (Note 2)
Input High Voltage, V_{IH1} (DE, DI, \overline{RE})	2.0			V	
Input Low Voltage, V_{IL1} (DE, DI, \overline{RE})			0.8	V	
DI Input Hysteresis, V_{HYS}		100		mV	
Input Current, I_{IN1} (DE, DI, \overline{RE})			± 2	μA	
Input Current (A and B), I_{IN4}			125 -75	μA μA	DE = GND, $V_{CC} = GND$ or 5.25V, $V_{IN} = 12V$ DE = GND, $V_{CC} = GND$ or 5.25V, $V_{IN} = -7V$
Output Leakage (Y and Z), Full Duplex, I_O	-100		125	μA μA	DE = GND, $V_{CC} = GND$ or 5.25V, $V_{IN} = 12V$ DE = GND, $V_{CC} = GND$ or 5.25V, $V_{IN} = -7V$
Driver Short-Circuit, V_{OD1}	-250			mA	$-7V \leq V_{OUT} \leq V_{CC}$ (Note 3)
Output Current	± 25		250	mA mA	$0V \leq V_{OUT} \leq 12V$ (Note 3) $0V \leq V_{OUT} \leq V_{CC}$ (Note 3)

ADM3082/ADM3085/ADM3088 SPECIFICATIONS (continued)

DCELECTRICAL CHARACTERISTICS

($V_{CC} = +5V \pm 5\%$, $T_A = T_{MIN}$ to T_{MAX} , unless otherwise noted. Typical values are at $V_{CC} = +5V$ and $T_A = +25^\circ C$.) (Note 1)

RECEIVER

Parameter	Min	Typ	Max	Units	Test Conditions/Comments
Receiver Differential Threshold Voltage, V_{TH}	-200	-125	-50	mV	$-7V \leq V_{CM} \leq 12V$
Receiver Input Hysteresis, ΔV_{TH}		25		mV	
Receiver Output High Voltage, V_{OH}	$V_{CC} - 1.5$			V	$I_O = -4mA$, $V_{ID} = -50mV$
Receiver Output Low Voltage, V_{OL}			0.4	V	$I_O = 4mA$, $V_{ID} = -200mV$
Three-State Output Current at Receiver, I_{OZR}			± 1	μA	$0.4V \leq V_O \leq 2.4V$
Receiver Input Resistance, R_{IN}	96			k Ω	$-7V \leq V_{CM} \leq 12V$
Receiver Output Short-Circuit Current, I_{OSR}	± 7		± 95	mA	$0V \leq V_{RO} \leq V_{CC}$

SUPPLY CURRENT

Parameter	Min	Typ	Max	Units	Test Conditions/Comments
Supply Current, I_{CC}		430	900	μA	No load, $\overline{RE} = DI = GND$ or V_{CC} , $DE = V_{CC}$
		375	600	μA	No load, $\overline{RE} = DI = GND$ or V_{CC} , $DE = GND$
Supply Current in Shutdown Mode, I_{SHDN}		0.001	10	μA	$DE = GND$, $V_{\overline{RE}} = V_{CC}$
ESD Protection for Y, Z, A, B		± 15		kV	Human Body Model

NOTES

¹All currents into the device are positive; all currents out of the device are negative. All voltages are referred to device ground unless otherwise noted.

² ΔV_{DO} and ΔV_{CC} are the changes in V_{OD} and V_{OC} , respectively, when the DI input changes state.

³Maximum current level applies to peak current just prior to foldback-current limiting; minimum current level applies during current limiting.

PRELIMINARY TECHNICAL DATA

ADM3082/ADM3085/ADM3088

ADM3082/ADM3085/ADM3088 SPECIFICATIONS (continued)

SWITCHING CHARACTERISTICS—ADM3082

($V_{CC} = +5V \pm 5\%$, $T_A = T_{MIN}$ to T_{MAX} , unless otherwise noted. Typical values are at $V_{CC} = +5V$ and $T_A = +25^\circ C$.) (Note 1)

Parameter	Min	Typ	Max	Units	Test Conditions/Comments
Driver Input-to-Output, t_{DPLH}	500	2030	2600	ns	Figures 2 and 3, $R_{DIFF} = 54\Omega$, $C_{L1} = C_{L2} = 100pF$
Driver Input-to-Output, t_{DPHL}	500	2030	2600	ns	
Driver Output Skew, $ t_{DPLH} - t_{DPHL} $, t_{DSKEW}		-3	± 200	ns	Figures 2 and 3, $R_{DIFF} = 54\Omega$, $C_{L1} = C_{L2} = 100pF$
Driver Rise or Fall Time, t_{DR} , t_{DF}	667	1320	2500	ns	Figures 2 and 3, $R_{DIFF} = 54\Omega$, $C_{L1} = C_{L2} = 100pF$
Maximum Data Rate, f_{MAX}	115			kbps	
Driver Enable to Output High, t_{DZH}			3500	ns	Figures 5 and 6, $C_L = 100pF$, S2 closed
Driver Enable to Output Low, t_{DZL}			3500	ns	Figures 5 and 6, $C_L = 100pF$, S1 closed
Driver Disable Time from Low, t_{DLZ}			100	ns	Figures 5 and 6, $C_L = 15pF$, S1 closed
Driver Disable Time from High, t_{DHZ}			100	ns	Figures 4 and 5, $C_L = 15pF$, S2 closed
Receiver Input to Output, t_{RPLH} , t_{RPHL}		127	200	ns	Figure 7; $ V_{ID} \geq 2.0V$; rise and fall time of $V_{ID} \leq 15ns$
Differential Receiver Skew, t_{RSKD} $ t_{RPLH} - t_{RPHL} $		3	± 30	ns	Figure 7; $ V_{ID} \geq 2.0V$; rise and fall time of $V_{ID} \leq 15ns$
Receiver Enable to Output Low, t_{RZL}		20	50	ns	Figures 7 and 8; $C_L = 100pF$, S1 closed
Receiver Enable to Output High, t_{RZH}		20	50	ns	Figures 7 and 8, $C_L = 100pF$, S2 closed
Receiver Disable Time from Low, t_{RLZ}		20	50	ns	Figures 7 and 8, $C_L = 100pF$, S1 closed
Receiver Disable Time from High, t_{RHZ}		20	50	ns	Figures 7 and 8 $C_L = 100pF$, S2 closed
Time to Shutdown, t_{SHDN}	50	200	600	ns	(Note 5)
Driver Enable from Shutdown to Output High, $t_{DZH(SHDN)}$			6000	ns	Figures 5 and 6, $C_L = 15pF$, S2 closed
Driver Enable from Shutdown to Output Low, $t_{DZL(SHDN)}$			6000	ns	Figures 5 and 6, $C_L = 15pF$, S1 closed
Receiver Enable from Shutdown to Output High, $t_{RZH(SHDN)}$			3500	ns	Figures 7 and 8, $C_L = 100pF$, S2 closed
Receiver Enable from Shutdown to Output Low, $t_{RZL(SHDN)}$			3500	ns	Figures 7 and 8, $C_L = 100pF$, S1 closed

ADM3082/ADM3085/ADM3088 SPECIFICATIONS (continued)

SWITCHING CHARACTERISTICS—ADM3085

(V_{CC} = +5V ±5%, T_A = T_{MIN} to T_{MAX}, unless otherwise noted. Typical values are at V_{CC} = +5V and T_A = +25°C.) (Note 1)

Parameter	Min	Typ	Max	Units	Test Conditions/Comments
Driver Input-to-Output, t _{DPLH}	250	720	1000	ns	Figures 2 and 3 R _{DIFF} = 54Ω,
Driver Input-to-Output, t _{DPHL}	250	720	1000	ns	C _{L1} = C _{L2} = 100pF
Driver Output Skew, t _{DPLH} - t _{DPHL} , t _{DSKEW}		-3	±100	ns	Figures 2 and 3, R _{DIFF} = 54Ω, C _{L1} = C _{L2} = 100pF
Driver Rise or Fall Time, t _{DR} , t _{DF}	200	530	750	ns	Figures 2 and 3, R _{DIFF} = 54Ω, C _{L1} = C _{L2} = 100pF
Maximum Data Rate, f _{MAX}	500			kbps	
Driver Enable to Output High, t _{DZH}			2500	ns	Figures 5 and 6, C _L = 100pF, S2 closed
Driver Enable to Output Low, t _{DZL}			2500	ns	Figures 5 and 6, C _L = 100pF, S1 closed
Driver Disable Time from Low, t _{DLZ}			100	ns	Figures 5 and 6, C _L = 15pF, S1 closed
Driver Disable Time from High, t _{DHZ}			100	ns	Figures 5 and 6, C _L = 15pF, S2 closed
Receiver Input to Output, t _{RPLH} , t _{RPHL}		127	200	ns	Figure 7; V _{ID} ≥ 2.0V; rise and fall time of V _{ID} ≤ 15ns
Differential Receiver Skew, t _{RSKD} t _{RPLH} - t _{RPHL}		3	±30	ns	Figure 7; V _{ID} ≥ 2.0V; rise and fall time of V _{ID} ≤ 15ns
Receiver Enable to Output Low, t _{RZL}		20	50	ns	Figures 7 and 8 C _L = 100pF, S1 closed
Receiver Enable to Output High, t _{RZH}		20	50	ns	Figures 7 and 8, C _L = 100pF, S2 closed
Receiver Disable Time from Low, t _{RLZ}		20	50	ns	Figures 7 and 8, C _L = 100pF, S1 closed
Receiver Disable Time from High, t _{RHZ}		20	50	ns	Figures 7 and 8, C _L = 100pF, S2 closed
Time to Shutdown, t _{SHDN}	50	200	600	ns	(Note 5)
Driver Enable from Shutdown to Output High, t _{DZH(SHDN)}			4500	ns	Figures 5 and 6, C _L = 15pF, S2 closed
Driver Enable from Shutdown to Output Low, t _{OZL(SHDN)}			4500	ns	Figures 5 and 6, C _L = 15pF, S1 closed
Receiver Enable from Shutdown to Output High, t _{RZH(SHDN)}			3500	ns	Figures 7 and 8, C _L = 100pF, S2 closed
Receiver Enable from Shutdown to Output Low, t _{RZL(SHDN)}			3500	ns	Figures 7 and 8, C _L = 100pF, S1 closed

ADM3082/ADM3085/ADM3088

ADM3082/ADM3085/ADM3088 SPECIFICATIONS (continued)

SWITCHING CHARACTERISTICS—ADM3088

(V_{CC} = +5V ±5%, T_A = T_{MIN} to T_{MAX}, unless otherwise noted. Typical values are at V_{CC} = +5V and T_A = +25°C.) (Note 1)

Parameter	Min	Typ	Max	Units	Test Conditions/Comments
Driver Input-to-Output, t _{DPLH} Driver Input-to-Output, t _{DPHL}		34	60	ns	Figures 2 and 5, R _{DIFF} = 54Ω, C _{L1} = C _{L2} = 100pF
Driver Output Skew, t _{DPLH} - t _{DPHL} , t _{DSKEW}		-2.5	±10	ns	Figures 2 and 5, R _{DIFF} = 54Ω, C _{L1} = C _{L2} = 100pF
Driver Rise or Fall Time, t _{DR} , t _{DF}		14	25	ns	Figures 7 and 9, R _{DIFF} = 54Ω, C _{L1} = C _{L2} = 100pF
Maximum Data Rate, f _{MAX}	10			Mbps	
Driver Enable to Output High, t _{DZH}			150	ns	Figures 5 and 6, C _L = 100pF, S2 closed
Driver Enable to Output Low, t _{DZL}			150	ns	Figures 5 and 6, C _L = 100pF, S1 closed
Driver Disable Time from Low, t _{DLZ}			100	ns	Figures 5 and 6, C _L = 15pF, S1 closed
Driver Disable Time from High, t _{DHZ}			100	ns	Figures 5 and 6, C _L = 15pF, S2 closed
Receiver Input-to-Output, t _{RPLH} , t _{RPHL}		106	150	ns	Figure 7; V _{ID} ≥ 2.0V; rise and fall time of V _{ID} ≤ 15ns
Differential Receiver Skew, t _{RSKD} t _{RPLH} - t _{RPHL}		0	±10	ns	Figures 7; V _{ID} ≥ 2.0V; rise and fall time of V _{ID} ≤ 15ns
Receiver Enable to Output Low, t _{RZL}		20	50	ns	Figures 7 and 8, C _L = 100pF, S1 closed
Receiver Enable to Output High, t _{RZH}		20	50	ns	Figures 7 and 8, C _L = 100pF, S2 closed
Receiver Disable Time from Low, t _{R LZ}		20	50	ns	Figures 7 and 8, C _L = 100pF, S1 closed
Receiver Disable Time from High, t _{RHZ}		20	50	ns	Figures 7 and 8, C _L = 100pF, S2 closed
Time to Shutdown, t _{SHDN}	50	200	600	ns	(Note 5)
Driver Enable from Shutdown to Output High, t _{DZH(SHDN)}			250	ns	Figures 5 and 6, C _L = 15pF, S2 closed
Driver Enable from Shutdown to Output Low, t _{DZL(SHDN)}			250	ns	Figures 5 and 6, C _L = 15pF, S1 closed
Receiver Enable from Shutdown to Output High, t _{RZH(SHDN)}			3500	ns	Figures 7 and 8, C _L = 100pF, S2 closed
Receiver Enable from Shutdown to Output Low, t _{RZL(SHDN)}			3500	ns	Figures 7 and 8, C _L = 100pF, S1 closed

NOTES

⁵The device is put into shutdown by bringing \overline{RE} high and DE low. If the enable inputs are in this state for less than 50ns, the device is guaranteed not to enter shutdown. If the enable inputs are in this state for at least 600ns, the device is guaranteed to have entered shutdown.

ADM3082/ADM3085/ADM3088 TEST CIRCUITS AND TIMING

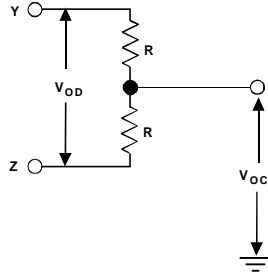

Figure 1. Driver DC Load Test Circuit

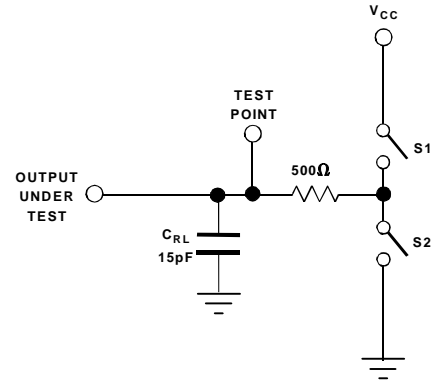

Figure 5. Test Load for Driver Enable/Disable Time Test

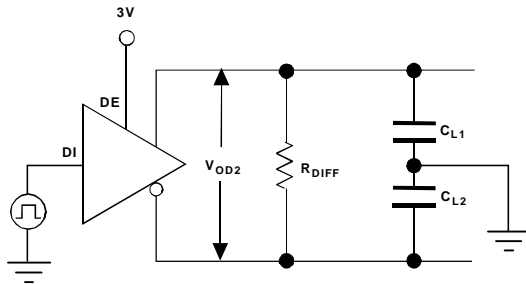

Figure 2. Test Load for Driver Timing Tests

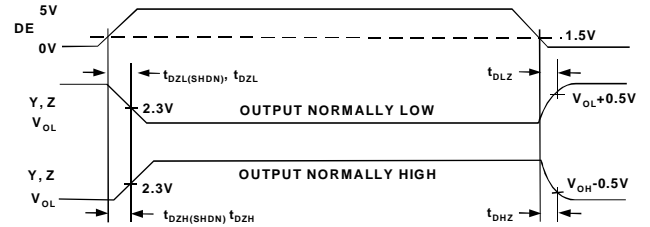

Figure 6. Driver Enable and Disable Times

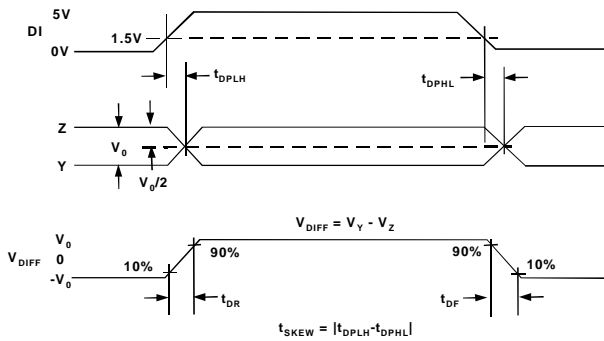

Figure 3. Driver Propagation Delays

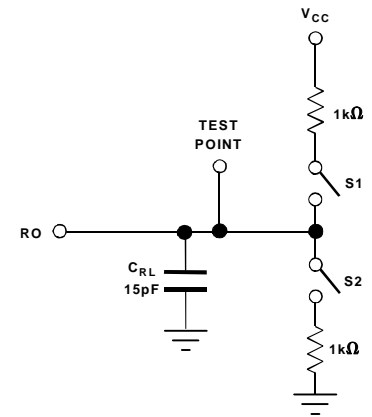

Figure 7. Test Load for Receiver Enable/Disable Time Test

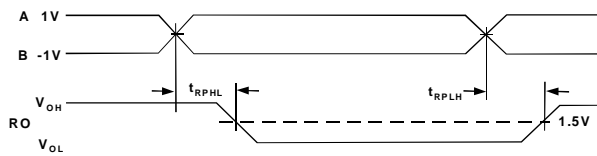

Figure 4. Receiver Propagation Delays

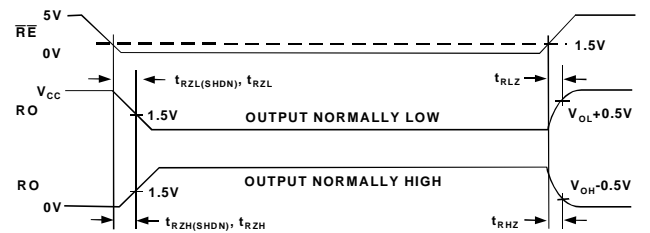

Figure 8. Receiver Enable and Disable Delay Times

PRELIMINARY TECHNICAL DATA

ADM3082/ADM3085/ADM3088

ABSOLUTE MAXIMUM RATINGS

Supply Voltage (V_{CC})	+7V
Logic Input Voltage	-0.3V to ($V_{CC}+0.3V$)
Driver Output Voltage (A, B)	$\pm 13V$
Receiver Input Voltage (A, B)	$\pm 13V$
Receiver Input Voltage, Full Duplex (A, B)	$\pm 13V$
Receiver Output Voltage (RO)	-0.3V to ($V_{CC}+0.3V$)
Continuous Power Dissipation	
8-Pin Plastic DIP	
(derate 9.09mW/°C above +70°C)	727mW
8-Pin Plastic SO	
(derate 5.88mW/°C above +70°C)	471mW
Maximum Junction Temperature (T_{Jmax})	150 °C
Storage Temperature Range	-65°C to +150°C
Lead Temperature, Soldering	
Vapor Phase 60 sec	+215°C
Infra-Red 15 sec	+200°C

*Stresses above those listed under "Absolute Maximum Ratings" may cause permanent damage to the device. This is a stress rating only; functional operation of the device at these or any other conditions above those indicated in the operational section of this specification is not implied. Exposure to absolute maximum rating conditions for extended periods may affect device reliability.

THERMAL CHARACTERISTICS

8-Pin Plastic DIP Package

θ_{JA} = tbd K/Watt, θ_{JC} = tbd K/Watt

8-Pin Plastic SO Package

θ_{JA} = tbd K/Watt, θ_{JC} = tbd K/Watt

PIN CONFIGURATION

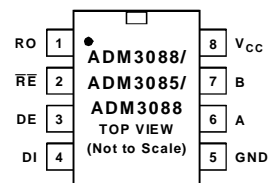

ORDERING INFORMATION

Model	Temperature Range	Package Option
ADM3082JN	0°C to +70°C	8 Pin Plastic DIP
ADM3082JR	0°C to +70°C	8 Pin SO
ADM3082AN	-40°C to +85°C	8 Pin Plastic DIP
ADM3082AR	-40°C to +85°C	8 Pin SO
ADM3085JN	0°C to +70°C	8 Pin Plastic DIP
ADM3085JR	0°C to +70°C	8 Pin SO
ADM3085AN	-40°C to +85°C	8 Pin Plastic DIP
ADM3085AR	-40°C to +85°C	8 Pin SO
ADM3088JN	0°C to +70°C	8 Pin Plastic DIP
ADM3088JR	0°C to +70°C	8 Pin SO
ADM3088AN	-40°C to +85°C	8 Pin Plastic DIP
ADM3088AR	-40°C to +85°C	8 Pin SO

ADM3082/ADM3085/ADM3088 TYPICAL PERFORMANCE CHARACTERISTICS

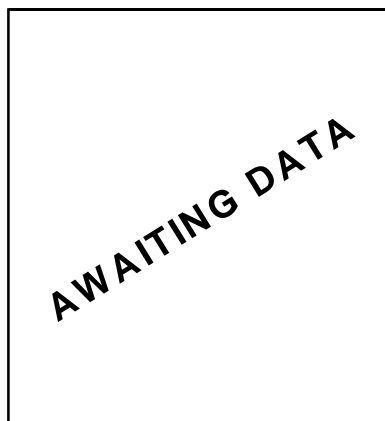

TPC1. No-load Supply Current vs. Temperature

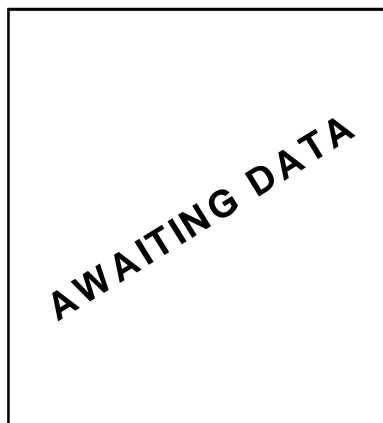

TPC2. Output Current vs. Receiver Output High Voltage

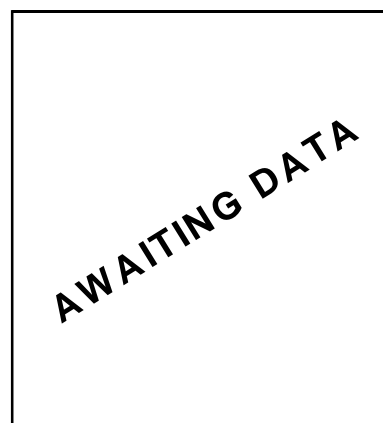

TPC3. Output Current vs. Receiver Output Low Voltage

ADM3082/ADM3085/ADM3088 TYPICAL PERFORMANCE CHARACTERISTICS (continued)

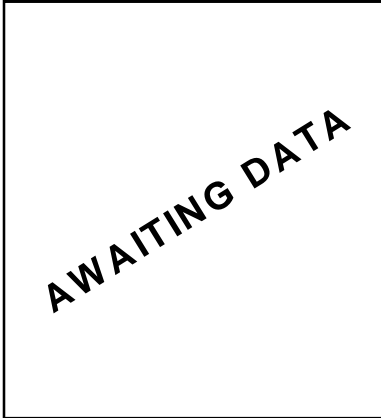

TPC4. Receiver Output High Voltage vs. Temperature

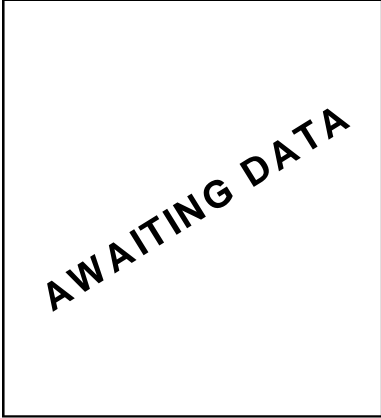

TPC5. Receiver Output Low Voltage vs. Temperature



TPC6. Shutdown Current vs. Temperature

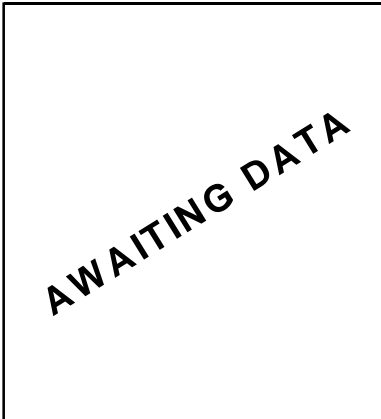

TPC7. ADM3082 Driver Propagation Delay vs. Temperature

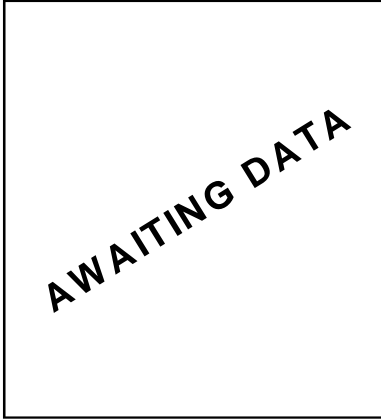

TPC8. ADM3085 Driver Propagation Delay vs. Temperature



TPC9. ADM3088 Driver Propagation Delay vs. Temperature

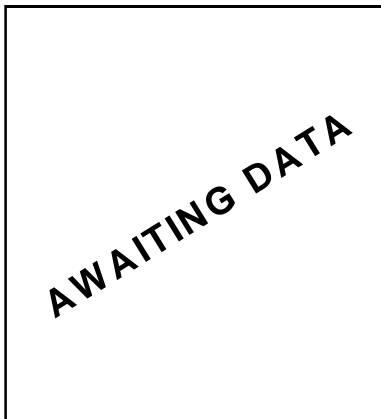

TPC10. ADM3082/5 Receiver Propagation Delay vs. Temperature

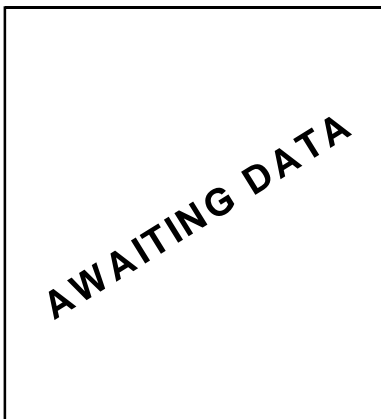

TPC11. ADM3088 Receiver Propagation Delay vs. Temperature

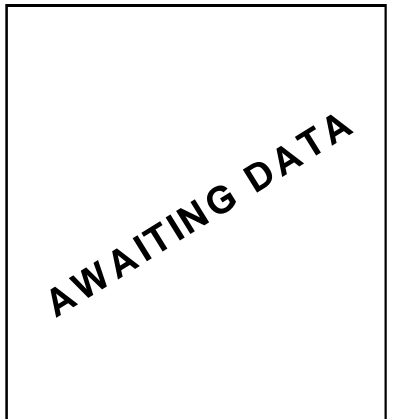

TPC12. Driver Differential Output Voltage vs. Temperature

PRELIMINARY TECHNICAL DATA

ADM3082/ADM3085/ADM3088

ADM3082/ADM3085/ADM3088 TYPICAL PERFORMANCE CHARACTERISTICS (continued)

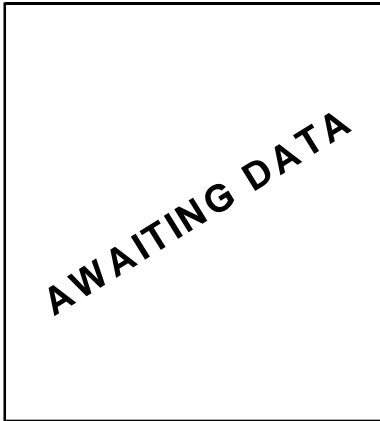

TPC13. Driver Output Current vs. Differential Output Voltage

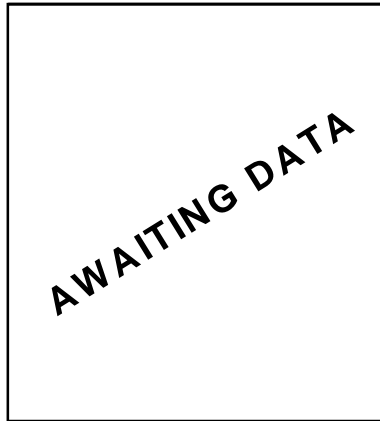

TPC14. Output Current vs. Driver Output High Voltage



TPC15. Output Current vs. Driver Output Low Voltage

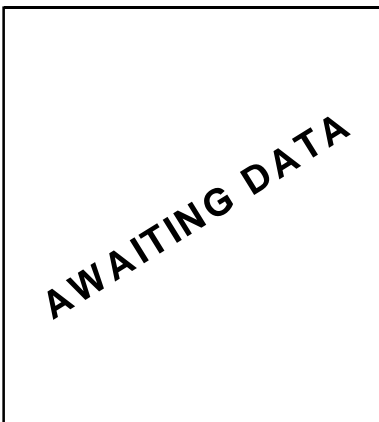

TPC16. ADM3082 Driver Propagation Delay

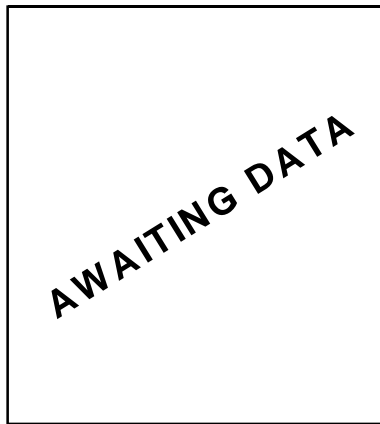

TPC17. ADM3085 Driver Propagation Delay

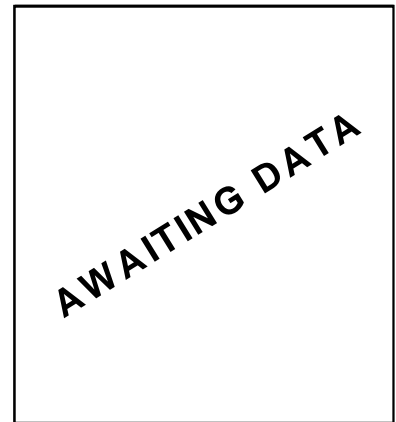

TPC18. ADM3088 Driver Propagation Delay

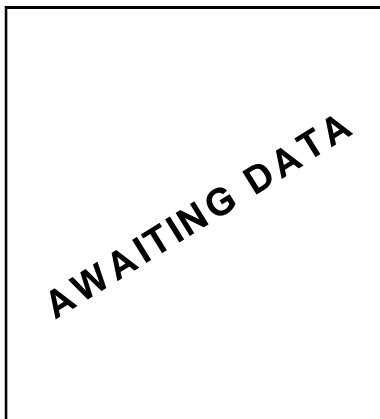

TPC19. ADM3082/5 Receiver Propagation Delay

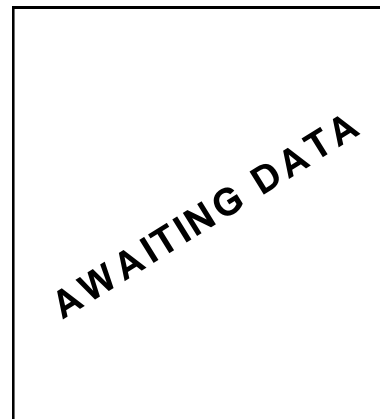

TPC20. ADM3088 Receiver Propagation Delay

PRELIMINARY TECHNICAL DATA

ADM3082/ADM3085/ADM3088

PIN FUNCTION DESCRIPTION

Pin	Mnemonic	Description
1	RO	Receiver Output. When \overline{RE} is low and $A - B \geq$ (more positive than) $-50mV$, RO will be high. When \overline{RE} is low and $A - B \leq$ (more negative than) $-200mV$, RO will be low.
2	\overline{RE}	Receiver Output Enable. Take \overline{RE} low to enable RO; RO is high impedance when \overline{RE} is high. Take \overline{RE} high and DE low to enter low-power shutdown mode.
3	DE	Driver Output Enable. Take DE high to enable driver outputs. These outputs are high impedance when DE is low. Take RE high and DE low to enter low-power shutdown mode.
4	DI	Driver Input. With DE high, a low on DI forces non-inverting output low and inverting output high. Similarly, a high on DI forces non-inverting output high and inverting output low.
5	GND	Ground
6	A	Non-Inverting Receiver Input and Non-Inverting Driver Output
7	B	Inverting Receiver Input and Inverting Driver Output
8	V_{CC}	Positive Supply $4.75V = V_{CC} = 5.25V$

DEVICE TRUTH TABLES

TRANSMITTING

INPUTS			OUTPUTS	
\overline{RE}	DE	DI	B/Z	A/Y
X	1	1	0	1
X	1	0	1	0
0	0	X	High-Z	High-Z
1	0	X	Shutdown	

RECEIVING

INPUTS			OUTPUT
\overline{RE}	DE	A-B	RO
0	X	$\geq -0.05V$	1
0	X	$\leq -0.2V$	0
0	X	Open/shorted	1
1	1	X	High-Z
1	0	X	Shutdown

X = Don't care

Shutdown mode, driver and receiver outputs high impedance

ADM3082/ADM3085/ADM3088

DETAILED DESCRIPTION

The ADM3082, ADM3085 and ADM3088 are high-speed RS-485/RS-422 transceivers offering enhanced performance over industry-standard devices. All devices in the family contain one driver and one receiver, but there is a choice of performance options. The devices feature fail-safe operation, which means that a logic-high receiver output is *guaranteed* when the receiver inputs are open-circuit or short-circuit, or when they are connected to a terminated transmission line with all drivers disabled (see the section on Fail-Safe Operation).

SLEW RATE CONTROL

The ADM3082 features a controlled slew-rate driver that minimize electromagnetic interference (EMI) and reduce reflections caused by incorrectly terminated cables, allowing error-free data transmission rates up to 115kbps (see the section on Reduced EMI and Reflections).

The ADM3085 offers a higher limit on driver output slew-rate, allowing data transmission rates up to 500kbps.

The driver slew rate of the ADM3088 is not limited, offering data transmission rates up to 10Mbps.

RECEIVER INPUT FILTERING

The receivers of all devices incorporate input hysteresis. In addition, when operating in 115kbps or 500kbps mode, the receivers of the ADM3082 and ADM3085 incorporate input filtering. This enhances noise immunity with differential signals that have very slow rise and fall times, but it does increase propagation delay by 20%.

HALF-/FULL-DUPLEX OPERATION

The ADM3082, ADM3085, and ADM3088 are dedicated half-duplex devices (driver outputs internally linked to receiver inputs). Figure 29 shows a typical half-duplex connection between two devices.

THREE-STATE BUS CONNECTION

All the devices have a Driver Enable pin (DE) that enables the driver outputs when taken high or puts the driver outputs into a high-impedance state when taken low. This allows several driver outputs to be connected to an RS-422/RS-485 bus.

Similarly, all the devices have a (active-low) Receiver Enable pin (\overline{RE}). Taking this low enables the receiver, while taking it high puts the receiver outputs into a high-impedance state. This allows several receiver outputs to be connected to a serial data bus.

HIGH INPUT IMPEDANCE

The input impedance of the devices is $96k\Omega$, which is 8 times higher than the standard RS-485 load of $12k\Omega$. A standard driver can driver 32 standard loads, so up to 256 ADM308X receivers, or a combination of ADM308X and other devices up to 32 unit loads, may be connected to an RS-422/RS485 bus driven by a single driver.

SHUTDOWN MODE

All the devices have a low power shutdown mode that is enabled by taking \overline{RE} high and DE low.

If shutdown mode is not used, the fact that DE is active-high and \overline{RE} is active-low offers a convenient way of switching the device between transmit and receive, by tying DE and \overline{RE} together. This is useful, for example, in applications using half duplex operation and where several receiver outputs are connected to a serial bus.

The device is guaranteed not to enter shutdown mode if DE and \overline{RE} are driven in this way. If DE is low and \overline{RE} is high for less than 50ns the device will not enter shutdown. If DE is low and \overline{RE} is high for greater than 600ns, the device is guaranteed to enter shutdown.

FAIL-SAFE OPERATION

The ADM3082/ADM3085/ADM3088 offer true fail-safe operation while remaining fully compliant with the $\pm 200mV$ EIA/TIA-485 standard. A logic-high receiver output is guaranteed when the receiver inputs are shorted together or open-circuit, or when they are connected to a terminated transmission line with all drivers disabled. This is done by setting the receiver threshold between $-50mV$ and $-200mV$. If the differential receiver input voltage (A-B) is greater than or equal to $-50mV$, RO is logic high. If A-B is less than or equal to $-200mV$, RO is logic low. In the case of a terminated bus with all transmitters disabled, the receiver's differential input voltage is pulled to 0V by ADM308X family, which results in a logic high with a 50mV minimum noise margin.

ENHANCED ESD PROTECTION

All Analog Devices parts incorporate protection against electrostatic discharge (ESD) to protect the devices during handling, assembly and normal operation. In addition, the ADM308X family has enhanced ESD protection up to $\pm 15kV$ on the receiver inputs and driver outputs (A, B) to protect against severe operational conditions such as line transients, connection and disconnection.

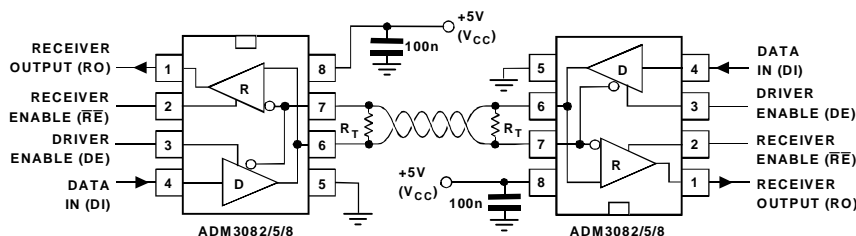

Figure 29. Half-Duplex Configuration for ADM3082, ADM3085 or ADM3088

ADM3082/ADM3085/ADM3088

CURRENT LIMIT AND THERMAL SHUTDOWN

The ADM3082/ADM3085/ADM3088 incorporate two protection mechanisms to guard the drivers against short-circuits, bus contention or other fault conditions. The first is a foldback current-limited output stage that protects the driver against short-circuits over the entire common-mode voltage range. The second is a thermal shutdown circuit that puts the driver outputs into a high-impedance state if the die temperature exceeds a safe limit.

REDUCED EMI AND REFLECTIONS

The ADM3082 and ADM3085 incorporate slew-rate limiting in the drivers. This reduces reflections due to incorrect cable termination and minimizes electromagnetic interference (EMI).

Figures 9 to 11 show driver output waveforms and Fourier analyses of 20kHz signals for the three different slew-rate settings. It can be seen that the harmonic content is greatly reduced for the ADM3085 and still further for the ADM3082 (Figures 10 and 9 respectively).

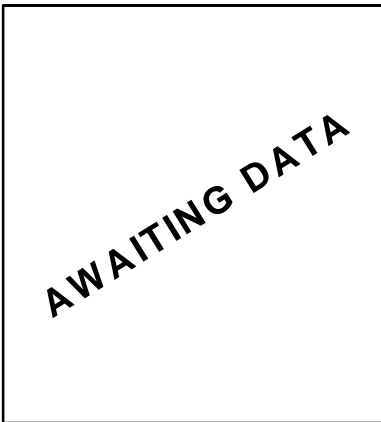

Figure 9 ADM3082 Driver Output Waveform and FFT Plot

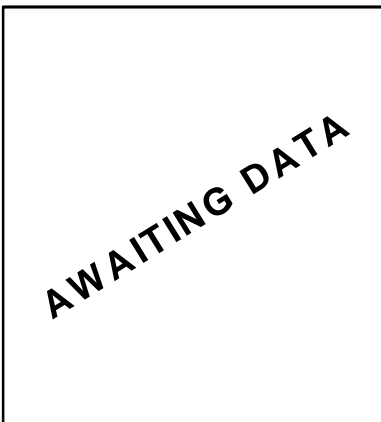

Figure 10. ADM3085 Driver Output Waveform and FFT Plot

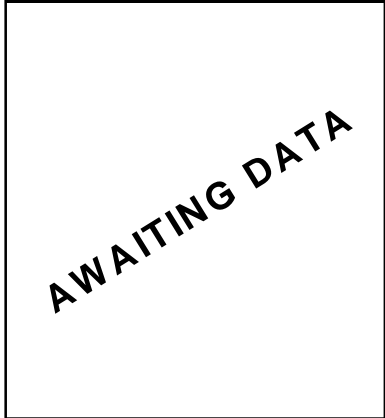

Figure 11. ADM3088 Driver Output Waveform and FFT Plot

The length of an unterminated stub that can be driven with only minor reflections depends on the rise time of the transmitter. A conservative estimate for this is given by the following equation:

$$L \text{ (metres)} = t_R / 49.2$$

where t_R is the transmitter's rise time in ns (multiply result by 3.28 for answer in feet).

For example, the rise time of the ADM3082 is typically 1320ns, which results in acceptable waveforms with stub lengths up to 27 metres. This is not the ultimate limit on unterminated stub length, as a system can still work if the waveform is allowed to settle before sampling the data.

The RS-485/RS-422 standard covers line lengths up to 4000 feet (1219 metres). Driver output and receiver output waveforms for the three slew rate settings, driving a 4000 foot cable, are shown in figures 12 to 14.

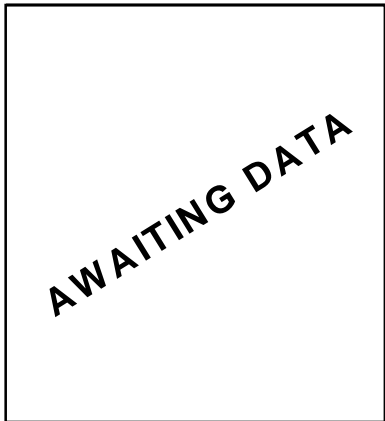

Figure 12. Driver Input, Driver Output and Receiver Output Waveforms of ADM3082, Driving 4000ft (1219m) of Cable at 50kHz

PRELIMINARY TECHNICAL DATA

ADM3082/ADM3085/ADM3088

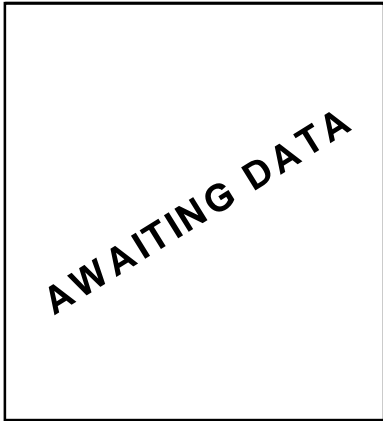

Figure 13. Driver Input, Driver Output and Receiver Output Waveforms of ADM3085, Driving 4000ft (1219m) of Cable at 50kHz



Figure 14. Driver Input, Driver Output and Receiver Output Waveforms of ADM3088, Driving 4000ft (1219m) of Cable at 200kHz

For line lengths in excess of 1220 metres the line should be split into smaller sections with intermediate repeaters.

APPLICATIONS

Figure 15 shows a typical application of the device on a half-duplex network. The line should be terminated at both ends to minimize reflections and any stubs off the main line should be kept as short as possible.

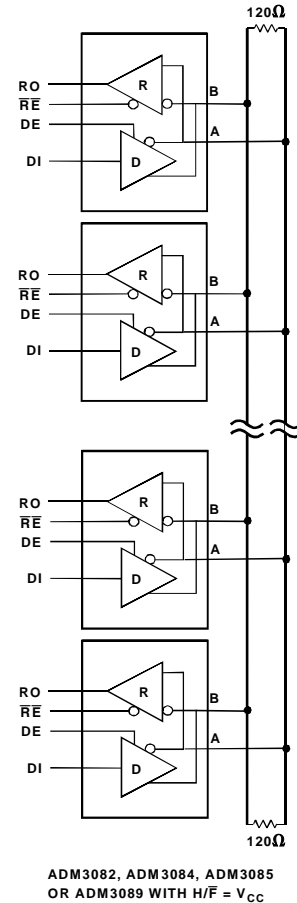
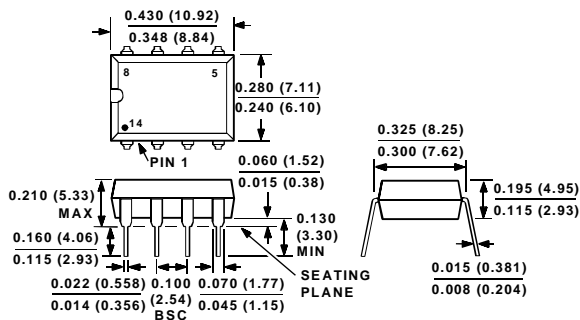

Figure 15. Typical Half-Duplex Network Application

OUTLINE DIMENSIONS

Dimensions shown in inches and (mm).

8-Pin Plastic Dual-In-Line Package (N-8)



8-Pin SO Package (R-8)

