

Silicon NPN Power Transistors

2SC5239

DESCRIPTION

www.datasheet4u.com

- With TO-220C package
- High voltage,high speed switching

APPLICATIONS

- For switching regulator and general purpose applications

PINNING

PIN	DESCRIPTION
1	Base
2	Collector;connected to mounting base
3	Emitter

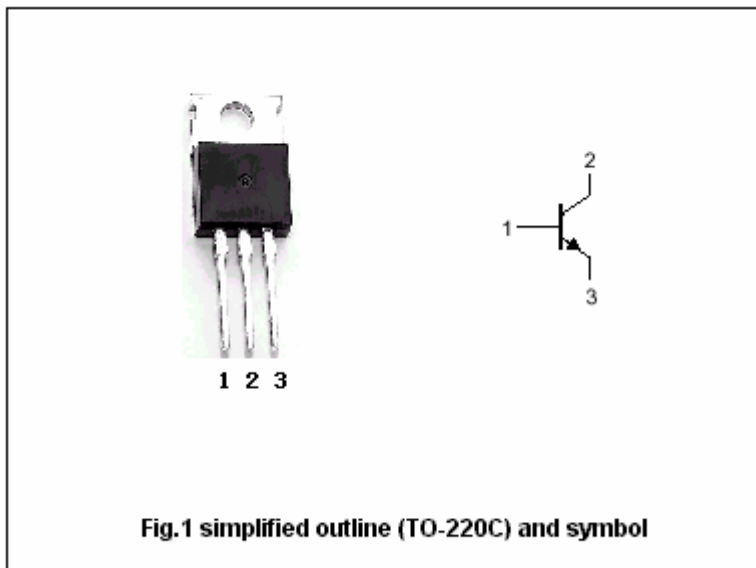

Fig.1 simplified outline (TO-220C) and symbol

Absolute maximum ratings(Ta=25°C)

SYMBOL	PARAMETER	CONDITIONS	VALUE	UNIT
V _{CBO}	Collector-base voltage	Open emitter	900	V
V _{CEO}	Collector-emitter voltage	Open base	550	V
V _{EBO}	Emitter-base voltage	Open collector	7	V
I _C	Collector current		3	A
I _{CM}	Collector current-Peak		6	A
I _B	Base current		1.5	A
P _C	Collector dissipation	T _C =25°C	50	W
T _j	Junction temperature		150	°C
T _{stg}	Storage temperature		-55~150	°C

Silicon NPN Power Transistors

2SC5239

CHARACTERISTICS

T_j=25°C unless otherwise specified

www.datasheet4u.com

SYMBOL	PARAMETER	CONDITIONS	MIN	TYP.	MAX	UNIT
V _{(BR)CEO}	Collector-emitter breakdown voltage	I _C =10mA ; I _B =0	550			V
V _{CEsat}	Collector-emitter saturation voltage	I _C =1A ; I _B =0.2A			0.5	V
V _{BEsat}	Base-emitter saturation voltage	I _C =1A ; I _B =0.2A			1.2	V
I _{CBO}	Collector cut-off current	V _{CB} =800V ; I _E =0			100	μA
I _{EBO}	Emitter cut-off current	V _{EB} =7V ; I _C =0			100	μA
h _{FE}	DC current gain	I _C =1A ; V _{CE} =4V	10		30	
f _T	Transition frequency	I _E =-0.25A ; V _{CE} =12V		6		MHz
C _{ob}	Collector output capacitance	f=1MHz ; V _{CB} =10V		35		pF

Switching times

t _{on}	Turn-on time	I _C =1A; I _{B1} =0.15A ; I _{B2} =-0.45A V _{CC} =250V; R _L =250Ω			0.7	μs
t _s	Storage time				4.0	μs
t _f	Fall time				0.5	μs

Silicon NPN Power Transistors

2SC5239

PACKAGE OUTLINE

www.datasheet4u.com

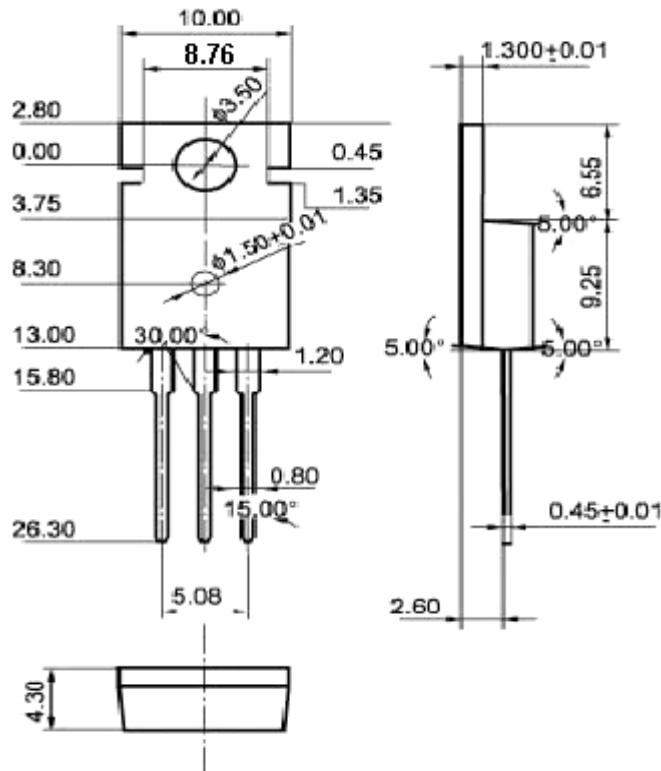

Fig.2 Outline dimensions (unindicated tolerance:±0.10 mm)

Silicon NPN Power Transistors

2SC5239

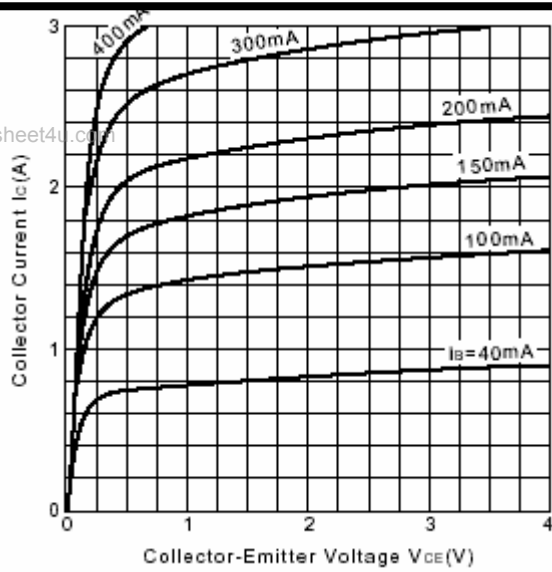

Fig.3 Static Characteristic

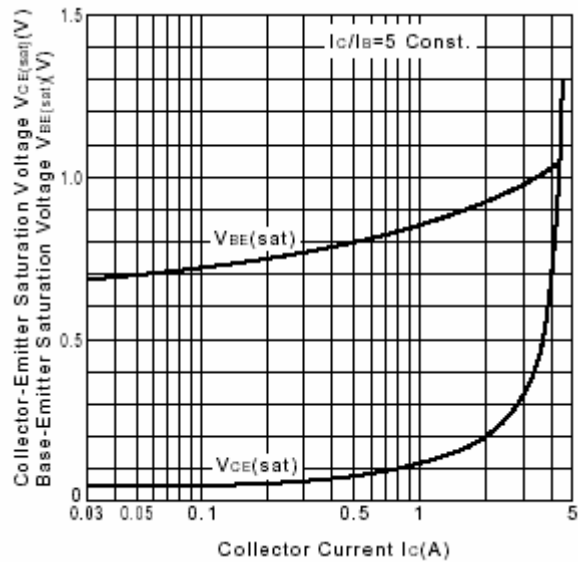

Fig.4 Base-Emitter Saturation Voltage
Collector-Emitter Saturation Voltage

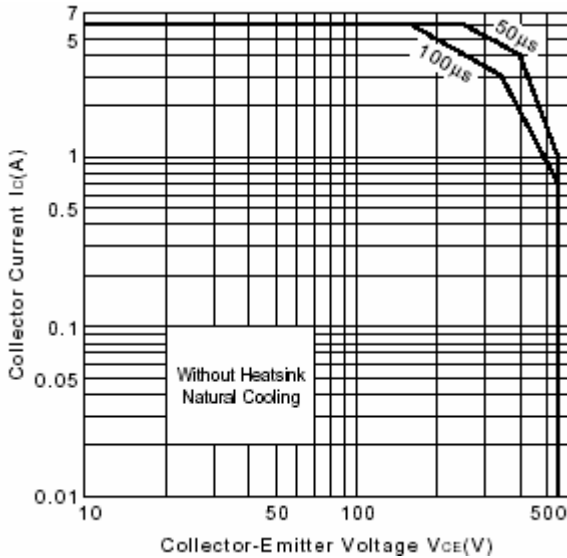

Fig.5 Safe Operating Area

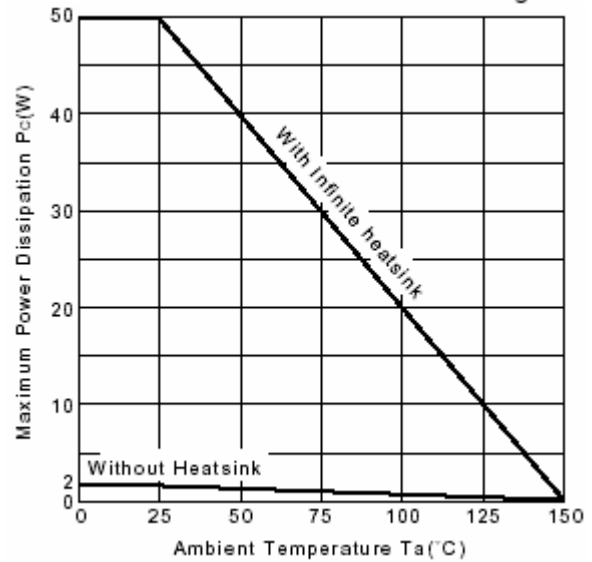

Fig.6 Pc-Ta Derating

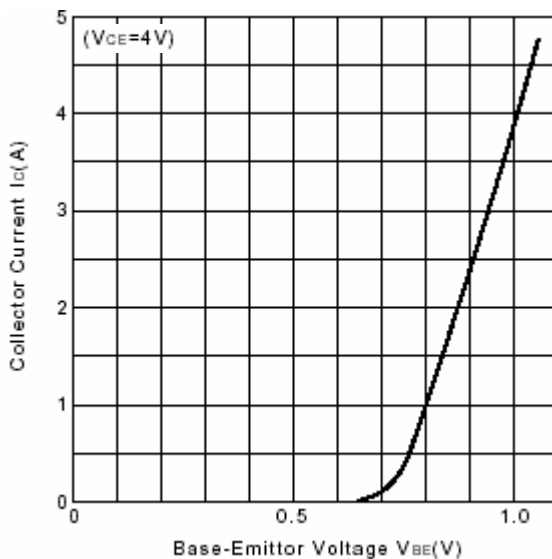

Fig.7 $I_C - V_{BE}$

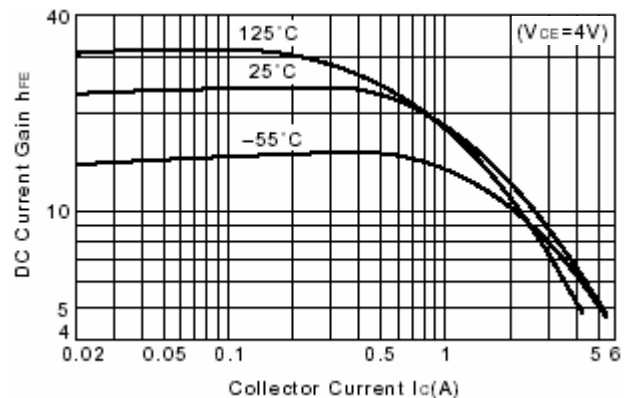

Fig.8 DC current Gain