

19-1780; Rev 0; 7/00

**EVALUATION KIT  
AVAILABLE**

# MAXIM

## Complete Dual-Band Quadrature Transmitters

### General Description

The MAX2366 dual-band, triple-mode complete transmitter for cellular phones represents the most integrated and architecturally advanced solution to date for this application. The device takes a differential I/Q baseband input and mixes it up to IF through a quadrature modulator and IF variable-gain amplifier (VGA). The signal is then routed to an external bandpass filter and upconverted to RF through an SSB mixer and RF VGA. The signal is further amplified with an on-board PA driver. Dual IF synthesizers, dual RF synthesizers, a local oscillator (LO) buffer, and a 3-wire programmable bus complete the basic functional blocks of this IC. The MAX2367 supports single-band, single-mode (PCS) operation. The MAX2368 supports single-band cellular dual-mode operation.

The MAX2366 enables architectural flexibility because its two IF voltage-controlled oscillators (VCOs), two IF ports, two RF LO input ports, and three PA driver output ports allow the use of a single receive IF frequency and split-band PCS filters for optimum out-of-band noise performance. The PA drivers allow up to three RF SAW filters to be eliminated. Select a mode of operation by loading data on the SPI™/QSPI™/MICROWIRE™-compatible 3-wire serial bus. Charge-pump current, sideband rejection, IF/RF gain balancing, standby, and shutdown are also controlled with the serial interface.

The MAX2366/MAX2367/MAX2368 come in a 48-pin QFN-EP package and are specified for the extended (-40°C to +85°C) temperature range.

### Applications

Triple-Mode, Dual-Mode, or Single-Mode  
Mobile Phones  
Satellite Phones  
Wireless Data Links (WAN/LAN)  
Wireless Local Area Networks (LANs)  
High-Speed Data Modems  
High-Speed Digital Cordless Phones  
Wireless Local Loop (WLL)

**Pin Configurations appear at end of data sheet.**

**Selector Guide appears at end of data sheet.**

SPI and QSPI are trademarks of Motorola, Inc.

MICROWIRE is a trademark of National Semiconductor Corp.

### Features

- ◆ Dual-Band, Triple-Mode Operation
- ◆ +7dBm Output Power with -54dBc ACPR
- ◆ 100dB Power Control Range
- ◆ Supply Current Drops as Output Power Is Reduced
- ◆ Dual Synthesizer for IF and RF LO
- ◆ Dual On-Chip IF VCO
- ◆ QSPI/SPI/MICROWIRE-Compatible 3-Wire Bus
- ◆ Digitally Controlled Operational Modes
- ◆ +2.7V to +5.5V Operation
- ◆ Single Sideband Upconverter Eliminates SAW Filters

### Ordering Information

PART	TEMP. RANGE	PIN-PACKAGE
MAX2366EGM	-40°C to +85°C	48 QFN-EP*
MAX2367EGM	-40°C to +85°C	48 QFN-EP*
MAX2368EGM	-40°C to +85°C	48 QFN-EP*

\*Exposed paddle

### Functional Diagram

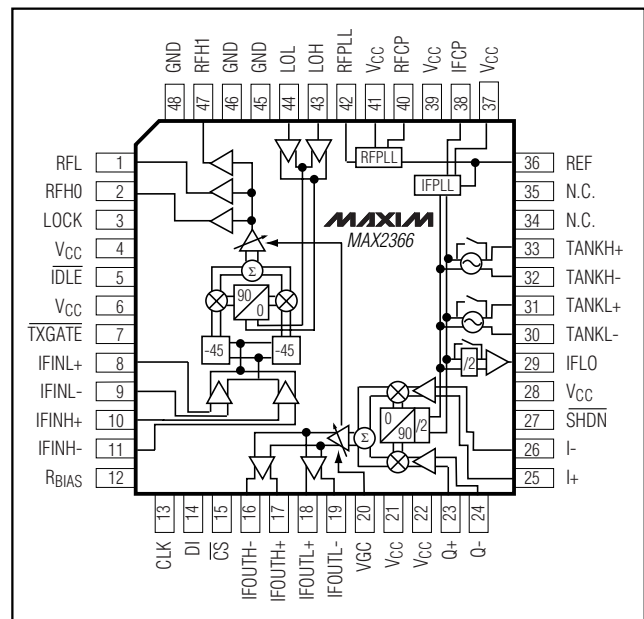

**MAX2366/MAX2367/MAX2368**

**MAXIM**

Maxim Integrated Products 1

**For price, delivery, and to place orders, please contact Maxim Distribution at 1-888-629-4642, or visit Maxim's website at [www.maxim-ic.com](http://www.maxim-ic.com).**

# Complete Dual-Band Quadrature Transmitters

## ABSOLUTE MAXIMUM RATINGS

V <sub>CC</sub> to GND .....	-0.3V to +3.6V	Continuous Power Dissipation (T <sub>A</sub> = +70°C)	
RFL, RFH0, RFH1 .....	+5.5V	48-Pin QFN-EP (derate 27mW/°C above +70°C) .....	2.5W
DI, CLK, CS, VGC, SHDN, TXGATE, IDLE, LOCK .....	-0.3V to (V <sub>CC</sub> + 0.3V)	Operating Temperature Range .....	-40°C to +85°C
AC Input Pins (IFINL, IFINH, Q, I, TANKL, TANKH, REF, RFPLL, LOL, LOH) .....	1.0V peak	Junction Temperature .....	+150°C
Digital Input Current (SHDN, TXGATE, IDLE, CLK, DI, CS) .....	±10mA	Storage Temperature Range .....	-65°C to +160°C
		Lead Temperature (soldering, 10s) .....	+300°C

Stresses beyond those listed under "Absolute Maximum Ratings" may cause permanent damage to the device. These are stress ratings only, and functional operation of the device at these or any other conditions beyond those indicated in the operational sections of the specifications is not implied. Exposure to absolute maximum rating conditions for extended periods may affect device reliability.

## ELECTRICAL CHARACTERISTICS

(MAX2366/7/8 test fixture: V<sub>CC</sub> = V<sub>BATT</sub> = +2.75V, SHDN = IDLE = TXGATE = +2.0V, VGC = +2.5V, R<sub>BIAS</sub> = 16kΩ, T<sub>A</sub> = -40°C to +85°C, unless otherwise noted. Typical values are at T<sub>A</sub> = +25°C, and operating modes are defined in Table 6.)

PARAMETER	CONDITIONS		MIN	TYP	MAX	UNITS
Operating Supply Voltage			2.7		3.0	V
Operating Supply Current	(Note 1)	PCS mode	VGC = 0.5V	92	118	mA
			VGC = 2.0V	97	123	
			VGC = 2.5V	132	161	
		Cellular digital mode	VGC = 0.5V	91	110	
			VGC = 2.0V	95	122	
			VGC = 2.5V	132	164	
		FM mode	VGC = 0.5V	85	110	
			VGC = 2.0V	89	114	
			VGC = 2.5V	114	142	
		Addition for IFLO buffer			6.5	
IDLE = 0.6V, cell idle			15	20		
TXGATE = 0.6V			26	34		
RFPLL off			11			
SHDN = 0.6V, sleep mode			0.5	20	μA	
Logic High	(Note 7)		2.0			V
Logic Low	(Note 7)				0.6	V
Logic Input Current	(Note 7)		-5		+5	μA
VGC Input Current	(Note 7)		-10		+10	μA
VGC Input Resistance During Shutdown	SHDN = 0.6V (Note 7)		225	280		kΩ
Lock Indicator High	50kΩ pullup load (Note 7)		V <sub>CC</sub> - 0.4			V
Lock Indicator Low	50kΩ pullup load (Note 7)				0.4	V

# Complete Dual-Band Quadrature Transmitters

MAX2366/MAX2367/MAX2368

## ELECTRICAL CHARACTERISTICS

(MAX2366/67/68 evaluation kit: 50Ω system, operating modes as defined in Table 6, input voltage at I and Q = 200mV<sub>RMS</sub> differential, common mode = V<sub>CC</sub>/2, 300kHz quadrature CW tones, RF and IF synthesizers locked with passive lead-lag second-order loop filter, REF = 200mV<sub>p-p</sub> at 19.68MHz, V<sub>CC</sub> = SHDN = IDLE = CS = TXGATE = +2.75V, V<sub>BAT</sub> = +2.75V, IF output load = 400Ω, LOH, LOL input power = -7dBm, f<sub>LOL</sub> = 966MHz, f<sub>LOH</sub> = 1750MHz, IF<sub>INH</sub> = 125mV<sub>RMS</sub> at 130MHz, IS-95 CDMA modulation f<sub>RFH0</sub> = f<sub>RFH1</sub> = 1880MHz, f<sub>RFL</sub> = 836MHz, T<sub>A</sub> = +25°C, unless otherwise noted.)

PARAMETER	CONDITIONS	MIN	TYP	MAX	UNITS
<b>MODULATOR, QUADRATURE MODES (CDMA, PCS, FM_IQ)</b>					
IF Frequency Range	IF_BAND = 0	120–235			MHz
	IF_BAND = 1	120–300			
I/Q Common-Mode Input Voltage	V <sub>CC</sub> = 2.7V to 3.0V (Notes 2, 3, 7)	1.35	V <sub>CC</sub> /2	V <sub>CC</sub> - 1.25	V
IF Gain Control Range	VGC = 0.5V to 2.5V, IFG = 100	85			dB
IF Output Power at IFOUTL and IFOUTH, CDMA Mode	VGC = 2.5V, IFG = 100, ACPR = -70dBc	-10			dBm
Gain Variation Over Temperature	Relative to +25°C, T <sub>A</sub> = -40°C to +85°C (Note 4)	-1		+1	dB
Carrier Suppression	VGC = 2.5V, IFG = 100	30	49		dB
Sideband Suppression	VGC = 2.5V, IFG = 100	30	38		dB
<b>MODULATOR, FM MODE</b>					
IF Gain Control Range	VGC = 0.5V to 2.5V, IFG = 100	85			dB
Output Power at IFOUTL	VGC = 2.5V, IFG = 111, I/Q modulation	-8.5			dBm
	VGC = 2.5V, IFG = 111, direct VCO modulation	-5.5			
<b>UPCONVERTER AND PREDRIVER</b>					
IF Frequency Range	IF_BAND = 0	120–200			MHz
	IF_BAND = 1	180–300			
RFL Frequency Range	RFL port	800–1000			MHz
RFH Frequency Range	RFH0 and RFH1 ports	1700–2000			MHz
LOL Frequency Range		800–1150			MHz
LOH Frequency Range		1400–2300			MHz
RFPLL Frequency Range	Cellular frequency operation	1300			MHz
	PCS frequency operation	2300			
Output Power, RFL Port	VGC = 2.5V	ACPR = -54dBc	7		dBm
		FM mode	12		
Output Power, RFH1 Port	VGC = 2.6V, ACPR = -54dBc	7.5			dBm
Output Power, RFH0 Port	VGC = 2.6V, ACPR = -54dBc	6.6			dBm
Power Control Range	VGC = 0.5V to 2.5V	30			dB
Gain Variation Over Temperature	Relative to +25°C, T <sub>A</sub> = -40°C to +85°C (Note 4)		±1	±2	dB
LO Leakage		-17			dBm
Image Signal		-29			dBc

# Complete Dual-Band Quadrature Transmitters

## ELECTRICAL CHARACTERISTICS (continued)

(MAX2366/67/68 evaluation kit: 50Ω system, operating modes as defined in Table 6, input voltage at I and Q = 200mV<sub>RMS</sub> differential, common mode = V<sub>CC</sub>/2, 300kHz quadrature CW tones, RF and IF synthesizers locked with passive lead-lag second-order loop filter, REF = 200mV<sub>p-p</sub> at 19.68MHz, V<sub>CC</sub> = SHDN = IDLE = CS = TXGATE = +2.75V, V<sub>BAT</sub> = +2.75V, IF output load = 400Ω, LOH, LOL input power = -7dBm, f<sub>LOL</sub> = 966MHz, f<sub>LOH</sub> = 1750MHz, IFINH = 125mV<sub>RMS</sub> at 130MHz, IS-95 CDMA modulation f<sub>RFH0</sub> = f<sub>RFH1</sub> = 1880MHz, f<sub>RFL</sub> = 836MHz, T<sub>A</sub> = +25°C, unless otherwise noted.)

PARAMETER	CONDITIONS	MIN	TYP	MAX	UNITS
<b>IF_PLL</b>					
Reference Frequency		5		30	MHz
Frequency Reference Signal Level		0.1		0.6	V <sub>p-p</sub>
IF Main Divide Ratio		256		16384	
IF Reference Divide Ratio		2		2048	
VCO Operating Range	VCO = 0	240–470			MHz
	VCO = 1	240–600			
IF LO Output Power	BUF_EN = 1		-6		dBm
Charge-Pump Source/Sink Current	ICP = 00 (Note 7)	115	175	230	μA
	ICP = 01 (Note 7)	145	235	315	
	ICP = 10 (Note 7)	235	350	470	
	ICP = 11 (Note 7)	300	465	625	
TurboLock Boost Current	(Note 5, 7)	265	450	615	μA
Charge-Pump Source/Sink Matching	Locked, all values of ICP, over specified compliance range (Note 6)		5		%
Charge-Pump High-Z Leakage	Over specified compliance range (Note 6)			10	nA
<b>RF_PLL</b>					
RF Main Divide Ratio		4096		262144	
RF Reference Divide Ratio		2		8192	
Maximum Phase-Detector Comparison Frequency			10		MHz
Charge-Pump Source/Sink Current	RCP = 00 (Note 7)	100	165	225	μA
	RCP = 01 (Note 7)	135	230	310	
	RCP = 10 (Note 7)	210	340	460	
	RCP = 11 (Note 7)	270	450	630	
TurboLock Boost Current	(Note 5, 6)	245	435	630	μA
Charge-Pump Source/Sink Matching	Locked, all values of RCP, over specified compliance range (Note 6, 7)		5		%
Charge-Pump High-Z Leakage	Over specified compliance range (Note 6)			10	nA
RFPLL Input Sensitivity		160			mV <sub>p-p</sub>

**Note 1:** See Table 6 for register settings.

**Note 2:** ACPR is met over the specified V<sub>CM</sub> range.

**Note 3:** V<sub>CM</sub> must be supplied by the I/Q baseband source with ±6μA capability.

**Note 4:** Guaranteed by design and characterization.

**Note 5:** When enabled, turboLock is active during acquisition and injects boost current in addition to the normal charge-pump current.

**Note 6:** Charge Pump Compliance range is 0.5V to V<sub>CC</sub> - 0.5V.

**Note 7:** >25°C guaranteed by production test. <25°C guaranteed by design and characterization.

# Complete Dual-Band Quadrature Transmitters

## Typical Operating Characteristics

(MAX2366EVKIT,  $V_{CC} = +2.75V$ ,  $T_A = +25^\circ C$ , unless otherwise noted.)

MAX2366/MAX2367/MAX2368

IF VCO VOLTAGE vs. TIME

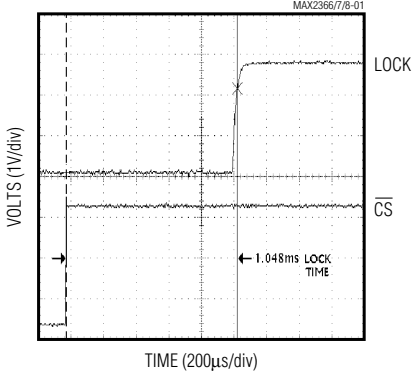

TANK 1/S11 vs. FREQUENCY

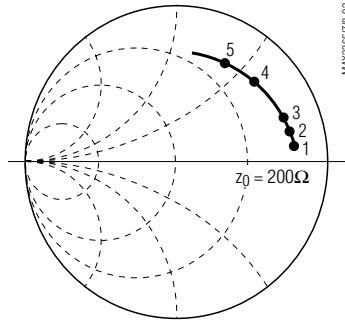

EQUIVALENT PARALLEL R-C    3: 330MHz, 1.58kΩ, 0.34pF  
 1: 200MHz, 1.76kΩ, 0.26pF    4: 780MHz, 1.21kΩ, 0.43pF  
 2: 260MHz, 1.66kΩ, 0.31pF    5: 1GHz, 0.94kΩ, 0.47pF

OUTPUT POWER, ACPR  
 $I_{CC}$  vs. VGC

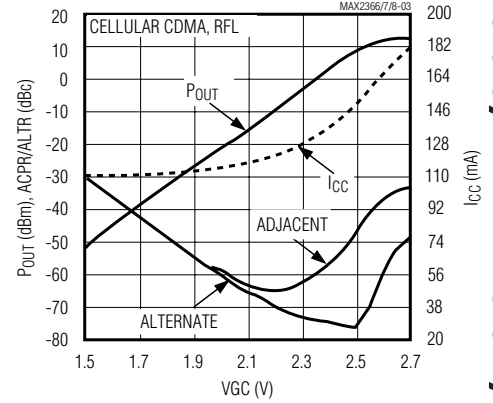

OUTPUT POWER, ACPR,  
 $I_{CC}$  vs. VGC

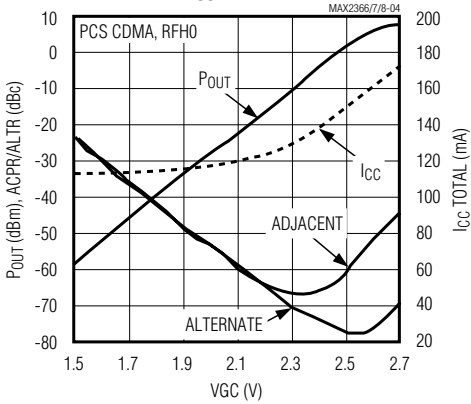

OUTPUT POWER, ACPR,  
 $I_{CC}$  TOTAL vs. VGC

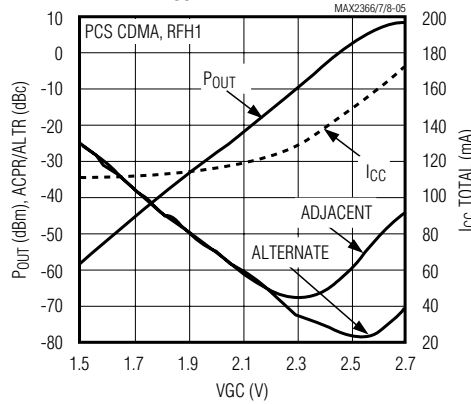

IF OUTPUT POWER  
 vs. VGC AND IF DAC SETTING

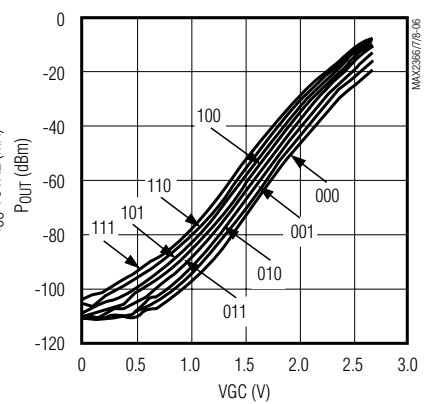

IF OUTPUT POWER vs. VGC

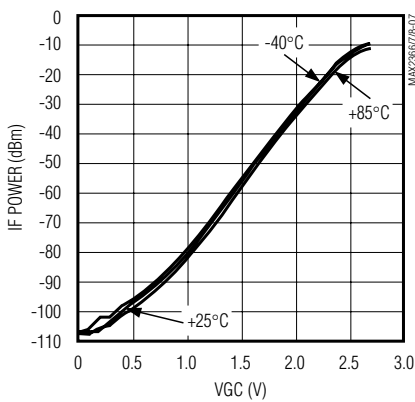

IF OUTPUT POWER vs. VGC

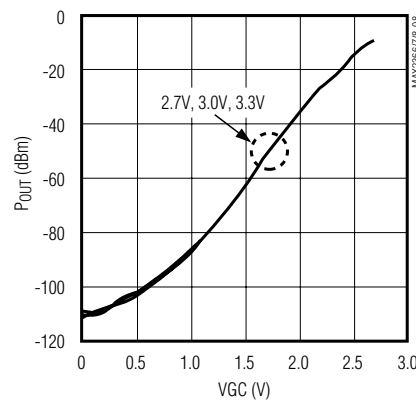

SIDEBAND SUPPRESSION AND  
 LO FEEDTHROUGH (IFOUTH)

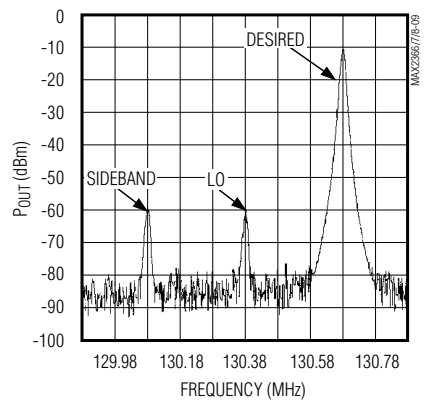

# Complete Dual-Band Quadrature Transmitters

## Typical Operating Characteristics (continued)

(MAX2366EVKIT,  $V_{CC} = +2.75V$ ,  $T_A = +25^\circ C$ , unless otherwise noted.)

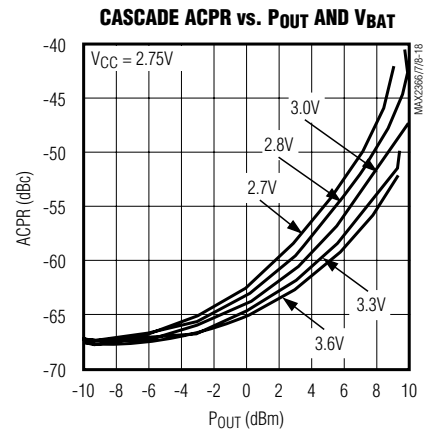
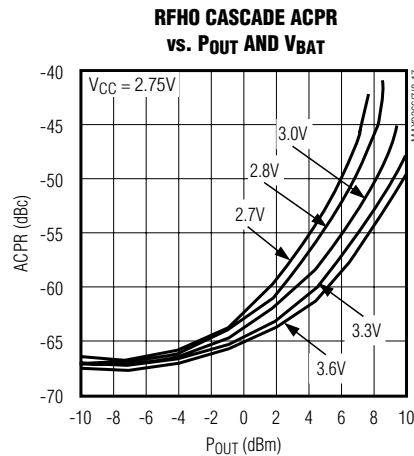
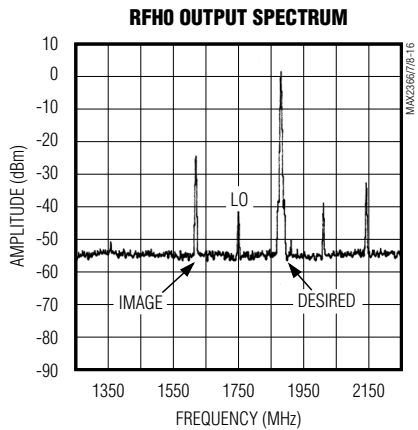
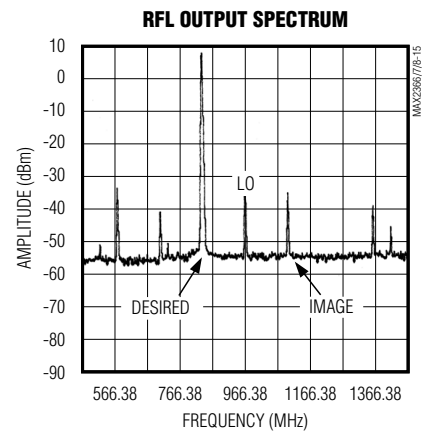
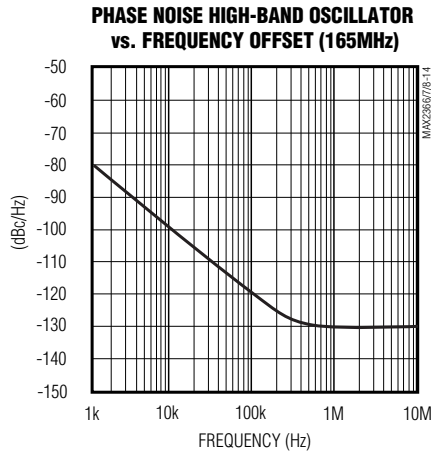
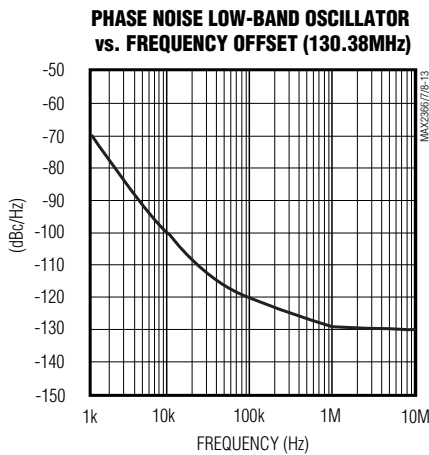
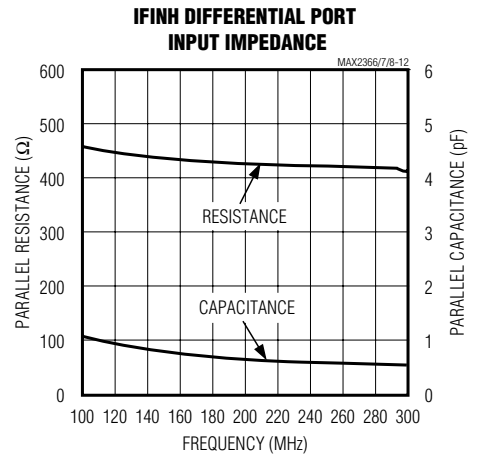
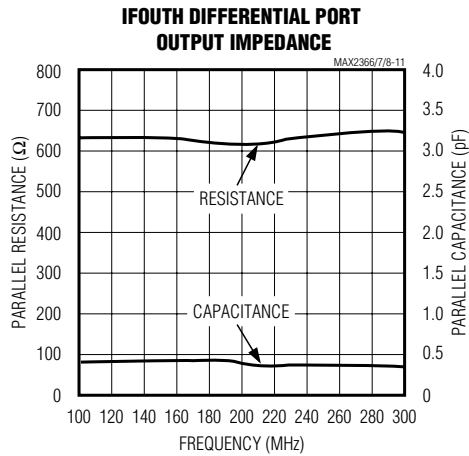
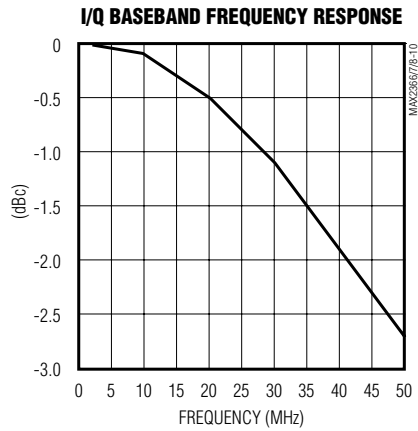

# Complete Dual-Band Quadrature Transmitters

## Typical Operating Characteristics (continued)

(MAX2366EVKIT,  $V_{CC} = +2.75V$ ,  $T_A = +25^\circ C$ , unless otherwise noted.)

MAX2366/MAX2367/MAX2368

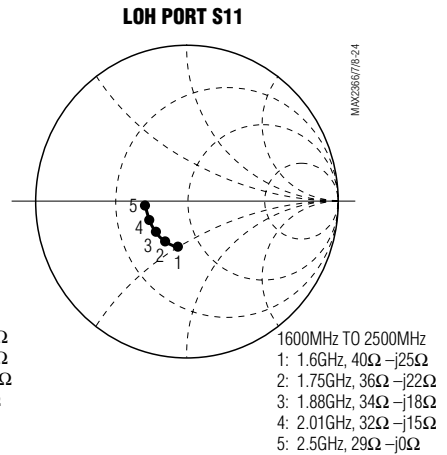
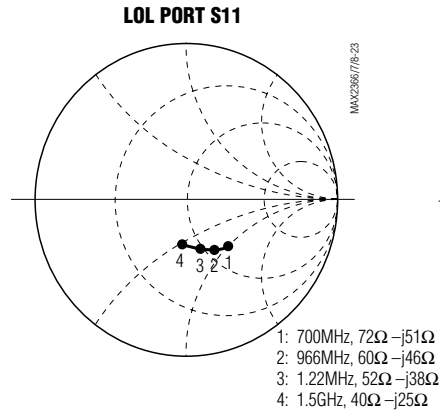
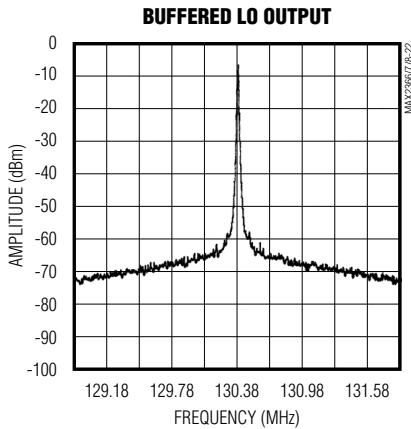
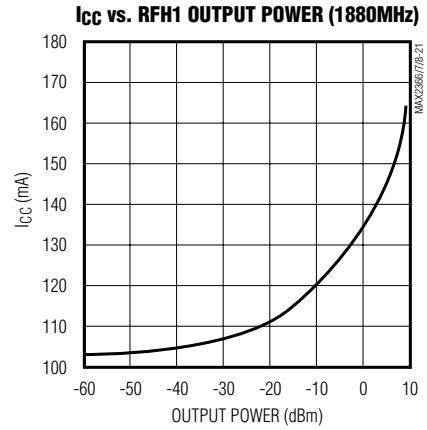
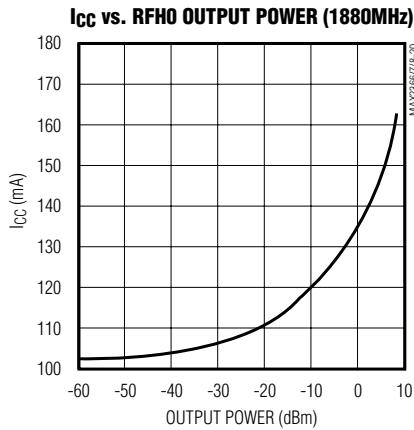
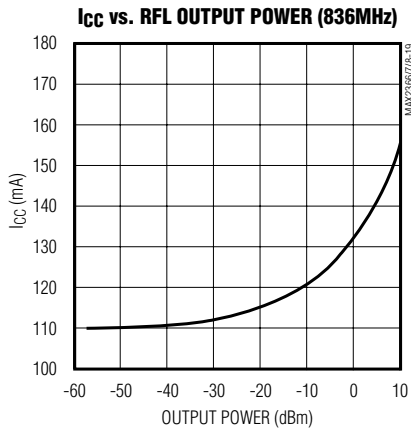

# Complete Dual-Band Quadrature Transmitters

## Pin Description

PIN			NAME	FUNCTION
MAX2366	MAX2367	MAX2368		
1	—	1	RFL	Transmitter RF Output for Cellular Band (800MHz to 1000MHz)—for both FM and digital modes. This open-collector output requires a pullup inductor to the supply voltage, which may be part of the output matching network and may be connected directly to the battery.
—	1, 8, 9, 18, 19, 30, 31, 34, 35, 44	2, 10, 11, 16, 17, 32–35, 43, 47	N.C.	No Connection. Make no connection to these pins.
2	2	—	RFH0	Transmitter RF Output for PCS Band (1700MHz to 2000MHz). This open-collector output requires a pullup inductor to the supply voltage. The pullup inductor may be part of the output matching network and may be connected directly to the battery.
3	3	3	LOCK	Open-Collector Output Indicating Lock Status of the IF and/or the RF PLLs. Requires a pullup resistor. Control using configuration register bit LD_MODE0, LD_MODE1.
4	4	4	VCC	Power Supply
5	5	5	$\overline{\text{IDLE}}$	Digital Input. A logic low on $\overline{\text{IDLE}}$ shuts down everything except the RF PLL and associated registers. A small R-C lowpass filter may be used to prevent digital noise.
6	6	6	VCC	Supply Pin for the Upconverter Stage. VCC must be bypassed to system ground as close to the pin as possible. The ground vias for the bypass capacitor should not be shared by any other branch.
7	7	7	$\overline{\text{TXGATE}}$	Digital Input. A logic low on $\overline{\text{TXGATE}}$ shuts down everything except the RF PLL, IF PLL, IF VCO, and serial bus and registers. This mode is used for gated transmission.
8, 9	—	8, 9	IFINL+, IFINL-	Differential Inputs to the RF Upconverter. These pins are internally biased to +1.5V. The input impedance for these ports is nominally 400 $\Omega$ differential. The IF filter should be AC-coupled to these ports. Keep the differential lines as short as possible to minimize stray pickup and shunt capacitance.
10, 11	10, 11	—	IFINH+, IFINH-	Differential Inputs to the RF Upconverter. These pins are internally biased to +1.5V. The input impedance for these ports is nominally 400 $\Omega$ differential. The IF filter should be AC-coupled to these ports. Keep the differential lines as short as possible to minimize stray pickup and shunt capacitance.
12	12	12	RBIAS	Bias Resistor Pin. RBIAS is internally biased to a bandgap voltage of +1.18V. An external resistor or current source must be connected to this pin to set the bias current for the upconverters and PA driver stages. The nominal resistor value is 16k $\Omega$ . This value can be altered to optimize the linearity of the driver stage.
13, 14, 15	13, 14, 15	13, 14, 15	CLK, DI, $\overline{\text{CS}}$	Input Pins from the 3-Wire Serial Bus (SPI/QSPI/MICROWIRE compatible). An R-C filter on each of these pins may be used to reduce noise.



# Complete Dual-Band Quadrature Transmitters

## Pin Description (continued)

MAX2366/MAX2367/MAX2368

PIN			NAME	FUNCTION
MAX2366	MAX2367	MAX2368		
16, 17	16, 17	—	IFOUTH-, IFOUTH+	Differential IF Outputs. These ports are active when the register bit IF_BAND is 1. They do not support FM mode. These pins must be inductively pulled up to V <sub>CC</sub> . A differential IF bandpass filter is connected between this port and IFINH+ or IFINH-. The pullup inductors can be part of the filter structure. The differential output impedance of this port is nominally 600Ω. The transmission lines from these pins should be short to minimize the pickup of spurious signals and noise.
18, 19	—	18, 19	IFOUTL+, IFOUTL-	Differential IF Outputs. These ports are active when the register bit IF_BAND is 0. These pins must be inductively pulled up to V <sub>CC</sub> . A differential IF bandpass filter is connected between this port and IFINL+ and IFINL-. The pullup inductors can be part of the filter structure. The differential output impedance of this port is nominally 600Ω. The transmission lines from these pins should be short to minimize the pickup of spurious signals and noise.
20	20	20	VGC	RF and IF Variable-Gain Control Analog Input. VGC floats to +1.5V. Apply +0.5V to +2.6V to control the gain of the RF and IF stages. An RC filter on this pin may be used to reduce DAC noise or PDM clock spurs from this line.
21	21	21	V <sub>CC</sub>	Supply Pin for the IF VGA. Bypass with a capacitor as close to the pin as possible. The bypass capacitor must not share its ground vias with any other branches.
22	22	22	V <sub>CC</sub>	Supply for the I/Q Modulator. Bypass with capacitor as close to the pin as possible. The bypass capacitor must not share its ground vias with any other branches.
23, 24	23, 24	23, 24	Q+, Q-	Differential Q-Channel Baseband Inputs to the Modulator. These pins go directly to the bases of a differential pair and require an external common-mode bias voltage.
25, 26	25, 26	25, 26	I+, I-	Differential I-Channel Baseband Inputs to the Modulator. These pins go directly to the bases of a differential pair and require an external common-mode bias voltage.
27	27	27	$\overline{\text{SHDN}}$	Shutdown Input. A logic low on $\overline{\text{SHDN}}$ shuts down the entire IC. An R-C low-pass filter may be used to reduce digital noise.
28	28	28	V <sub>CC</sub>	Supply Pin to the VCO Section. Bypass as close to the pin as possible. The bypass capacitor should not share its vias with any other branches.
29	29	29	IFLO	NBuffered LO Output. Control the output buffer using register bit BUF_EN and the divide ratio using the register bit BUF_DIV.
30, 31	—	30, 31	TANKL-, TANKL+	Differential Tank Pins for the Low-Frequency IF VCO. These pins are internally biased to +1.6V.

# Complete Dual-Band Quadrature Transmitters

## Pin Description (continued)

PIN			NAME	FUNCTION
MAX2366	MAX2367	MAX2368		
32, 33	32, 33	—	TANKH-, TANKH+	Differential Tank Pins for the High-Frequency IF VCO. These pins are internally biased to +1.6V.
34, 35	—	—	N.C.	No Connection. Leave these pins floating.
36	36	36	REF	Reference Frequency Input. REF is internally biased to $V_{CC} - 0.7V$ and must be AC-coupled to the reference source. This is a high-impedance port ( $25k\Omega \parallel 3pF$ ).
37	37	37	$V_{CC}$	Supply for the IF Charge Pump. This supply can differ from the system $V_{CC}$ . Bypass as close to the pin as possible. The bypass capacitor must not share its vias with any other branches.
38	38	38	IFCP	High-Impedance Output of the IF Charge Pump. Connect to the tune input of the IF VCOs through the IF PLL loop filter. Keep the line from IFCP to the tune input as short as possible to prevent spurious pickup, and connect the loop filter as close to the tune input as possible.
39	39	39	$V_{CC}$	Supply Pin for Digital Circuitry. Bypass as close to the pin as possible. The bypass capacitor must not share its vias with any other branch.
40	40	40	RFCP	High-Impedance Output of the RF Charge Pump. Connect to the tune input of the RF VCOs through the RF PLL loop filter. Keep the line from this pin to the tune input as short as possible to prevent spurious pickup, and connect the loop filter as close to the tune input as possible.
41	41	41	$V_{CC}$	Supply for the RF Charge Pump. This supply can differ from the system $V_{CC}$ . Bypass as close to the pin as possible. The bypass capacitor must not share its vias with any other branches.
42	42	42	RFPLL	RF PLL Input. AC-couple this port to the RF VCO.
43	43	—	LOH	High-band RF LO Input Port. AC-couple to this port.
44	—	44	LOL	Low-band RF LO Input Port. AC-couple to this port.
45, 46, 48	45, 46, 48	45, 46, 48	GND	Ground. Connect to PC board ground plane.
47	47	—	RFH1	Transmitter RF Output for PCS Band (1700MHz to 2000MHz). This open-collector output requires a pullup inductor to the supply voltage. The pullup inductor may be part of the output matching network and may be connected directly to the battery.
Exposed paddle	Exposed paddle	Exposed paddle	GND	DC and AC GND Return for the IC. Connect to PC board ground plane using multiple vias.

# Complete Dual-Band Quadrature Transmitters

MAX2366/MAX2367/MAX2368

## Detailed Description

The MAX2366 complete quadrature transmitter accepts differential I/Q baseband inputs with external common-mode bias. A modulator upconverts this to IF frequency in the 120MHz to 300MHz range. A gain control voltage pin (VGC) controls the gain of both the IF and RF VGAs simultaneously to achieve best noise and linearity performance. The IF signal is brought off-chip for filtering, then fed to a single sideband upconverter followed by the RF VGA and PA driver. The RF upconverter requires an external VCO for operation. The IF PLL, RF PLL, and operating mode can be programmed by an SPI/QSPI/MICROWIRE-compatible 3-wire interface.

The following sections describe each block in the MAX2366 *Functional Diagram*.

### I/Q Modulator

Differential in-phase (I) and quadrature-phase (Q) input pins are designed to be DC-coupled and biased with the baseband output from a digital-to-analog converter (DAC). I and Q inputs need a DC bias of  $V_{CC}/2$  and a current-drive capability of 6 $\mu$ A. Common-mode voltage will work within a 1.35V to ( $V_{CC} - 1.25V$ ) range. Typically, I and Q will be driven differentially with a 200mV<sub>RMS</sub> baseband signal. Optionally, I and Q may be programmed for 100mV<sub>RMS</sub> operation with the IQ\_LEVEL bit in the configuration register. The IF VCO output is fed into a divide-by-two/quadrature generator block to derive quadrature components to drive the IQ modulator. The output of the modulator is fed into the VGA.

### IF VCOs

There are two VCOs to support high IF and low IF applications. The VCOs oscillate at twice the desired IF frequency. Oscillation frequency is determined by external tank components (see *Applications Information*). Typical phase-noise performance for the tank is as shown in Table 1. The high-band and low-band VCOs can be selected independently of the IF port being used.

**Table 1. Typical VCO Phase Noise (IF = 130.38MHz)**

OFFSET (kHz)	PHASE NOISE (dBc)
1	-80
12.5	-105
30	-111
120	-121
900	-128

### IFLO Output Buffer

IFLO provides a buffered LO output when BUF\_EN is 1. The IFLO output frequency is equal to the VCO frequency when BUF\_DIV is 0, and half the VCO frequency when BUF\_DIV is 1. The output power is -6dBm. This output is intended for applications where the receiver IF is the same frequency as the transmit IF.

### IF/RF PLL

The IF/RF PLL uses a charge-pump output to drive a loop filter. The loop filter will typically be a passive second-order lead lag filter. Outside the filter's bandwidth, phase noise will be determined by the tank components. The two components that contribute most significantly to phase noise are the inductor and varactor. Use high-Q inductors and varactors to maximize equivalent parallel resistance. The IF\_TURBO\_CHARGE and the RF\_TURBO\_CHARGE bits in the CONFIG register can be set to 1 to enable turbo mode. Turbo mode provides maximum charge-pump current during frequency acquisition. Turbo mode is disabled after the second transition from phase lead to phase lag or from phase lag to phase lead. Turbo mode is also disabled after frequency acquisition is achieved. When turbo mode is disabled, charge-pump current will return to the programmed levels as set by ICP and RCP bits in the CONFIG register (Table 4).

### IF VGA

The IF VGA allows varying an IF output level that is controlled by the VGs. The voltage range on VGC of +0.5V to +2.6V provides a gain-control range of 85dB. There are two differential IF output ports from the VGA. IFOUTL+/IFOUTL- are optimized for low IF operation (120MHz to 235MHz) for IFOUTH+/IFOUTH- support high IF operation (120MHz to 300MHz). IFOUTL ports support direct VCO FM modulation. The differential IF output port has an output impedance of 600 $\Omega$  when pulled up to  $V_{CC}$  through a choke.

### Single Sideband Mixer

The RF transmit mixer uses a single sideband architecture to eliminate an off-chip RF filter. The single sideband mixer has IF input stages that correspond to IF output ports of the VGA. The mixer is followed by the RF VGA. The RF VGA is controlled by the same VGC pin as the IF VGA to provide optimum linearity and noise performance. The total power control range is >100dB.

### PA Driver

The MAX2366 includes three power-amplifier (PA) drivers. Each is optimized for the desired operating frequency. RFL is optimized for cellular-band operation.

# Complete Dual-Band Quadrature Transmitters

RFH0 and RFH1 are optimized for split-band PCS operation. The PA drivers have open-collector outputs and require pullup inductors. The pullup inductors can act as the shunt element in a shunt series match.

## Programmable Registers

The MAX2366/MAX2367/MAX2368 include seven programmable registers consisting of four divide registers, a configuration register, an operational control register, and a test register. Each register consists of 24 bits. The 4 least significant bits (LSBs) are the register's address. The 20 most significant bits (MSBs) are used for register data. All registers contain some "don't care" bits. These can be either a zero or a 1 and do not affect operation (Figure 1). Data is shifted in MSB first, followed by the 4-bit address. When  $\overline{CS}$  is low, the clock is active and data is shifted with the rising edge of the clock. When  $\overline{CS}$  transitions to high, the shift register is latched into the register selected by the contents of the address bits. Power-up defaults for the seven registers are shown in Table 2. The dividers and control registers are programmed from the SPI/QSPI/MICROWIRE-compatible serial port.

The RFM register sets the main frequency divide ratio for the RF PLL. The RFR register sets the reference frequency divide ratio. The RF VCO frequency can be determined by the following:

$$\text{RF VCO frequency} = f_{\text{REF}} \times (\text{RFM} / \text{RFR})$$

IFM and IFR registers are similar:

$$\text{IF VCO frequency} = f_{\text{REF}} \times (\text{IFM} / \text{IFR})$$

where  $f_{\text{REF}}$  is the external reference frequency.

The operational control register (OPCTRL) controls the state of the MAX2366/MAX2367/MAX2368. See Table 3 for the function of each bit.

The configuration register (CONFIG) sets the configuration for the RF/IF PLL and the baseband I/Q input levels. See Table 4 for a description of each bit.

The test register is not needed for normal use.

## Power Management

Bias control is distributed among several functional sections and can be controlled to accommodate many different power-down modes as shown in Table 5.

The shutdown control bit is of particular interest since it differs from the  $\overline{SHDN}$  pin. When the shutdown control bit is active ( $\text{SHDN\_BIT} = 0$ ), the serial interface is left active so that the part can be turned on with the serial bus while all other functions remain shut off. In contrast, when the  $\overline{SHDN}$  pin is low it shuts down everything. In either case, PLL programming and register information is lost. To retain the register information, use standby mode ( $\text{STBY} = 0$ ).

## Signal Flow Control

Table 6 shows an example of key registers for triple-mode operation, assuming half-band PCS and IF frequencies of 130MHz/165MHz.

## Applications Information

The MAX2366 is designed for use in dual-band, triple-mode systems. It is recommended for triple-mode handsets (Figure 2). The MAX2367 is designed for use in CDMA PCS handsets or WLL single-mode 2.4GHz ISM systems (Figure 3). The MAX2368 is designed for use in dual-mode cellular systems (Figure 4).

## 3-Wire Interface

Figure 5 shows the 3-wire interface timing diagram. The 3-wire bus is SPI/QSPI/MICROWIRE compatible.

**Table 2. Register Power-Up Default States**

REGISTER	DEFAULT	ADDRESS	FUNCTION
RFM	172087 dec	0000 <sub>b</sub>	RF M divider count
RFR	1968 dec	0001 <sub>b</sub>	RF R divider count
IFM	6519 dec	0010 <sub>b</sub>	IF M divider count
IFR	0492 dec	0011 <sub>b</sub>	IF R divider count
OPCTRL	892F hex	0100 <sub>b</sub>	Operational control settings
CONFIG	D03F hex	0101 <sub>b</sub>	Configuration and setup control
TEST	0000 hex	0111 <sub>b</sub>	Test-mode control

# Complete Dual-Band Quadrature Transmitters

MAX2366/MAX2367/MAX2368

		24-BIT REGISTER																				ADDRESS			
		DATA 20 BITS																ADDRESS 4 BITS							
		B19	B18	B17	B16	B15	B14	B13	B12	B11	B10	B9	B8	B7	B6	B5	B4	B3	B2	B1	B0	A3	A2	A1	A0
RFM DIVIDE REGISTER		RFM DIVIDE RATIO (18)																		ADDRESS					
		X	X																			0	0	0	0
RFR DIVIDE REGISTER		RFR DIVIDE RATIO (13)													ADDRESS										
		X	X	X	X	X	X	X														0	0	0	1
IFM DIVIDE REGISTER		IFM DIVIDE RATIO (14)														ADDRESS									
		X	X	X	X	X	X															0	0	1	0
IFR DIVIDE REGISTER		IFR DIVIDE RATIO (11)											ADDRESS												
		X	X	X	X	X	X	X	X	X												0	0	1	1
CONTROL REGISTER		CONTROL BITS (16)																ADDRESS							
		X	X	X	X																	0	1	0	0
CONFIGURATION REGISTER		CONFIGURATION BITS (16)																ADDRESS							
		X	X	X	X																	0	1	0	1
TEST REGISTER		TEST BITS (8)								ADDRESS															
		X	X	X	X	X	X	X	X	X	X	X										0	1	1	1

X = DON'T CARE

Figure 1. Register Configuration

## Electromagnetic Compliance Considerations

Two major concepts should be employed to produce a noise-free and EMC-compliant transmitter: minimize circular current-loop area to reduce H-field radiation and minimize voltage drops to reduce E-field radiation. To minimize the circular current-loop area, bypass as close to the part as possible and use the distributed capacitance of a ground plane. To minimize voltage drops, make VCC traces short and wide, and make RF traces short.

The “don't care” bits in the registers should be zero in order to minimize electromagnetic radiation due to unnecessary bit banging. RC filtering can also be used to slow the clock edges on the 3-wire interface, reducing high-frequency spectral content. RC filtering also

provides for transient protection against IEC802 testing by shunting high frequencies to ground, while the series resistance attenuates the transients for error-free operation. The same applies to the override pins (SHDN, TXGATE, IDLE).

High-frequency bypass capacitors are required close to the pins with a dedicated via to ground. The 48-pin QFN-EP package provides minimal inductance ground by using an exposed paddle under the part. Provide at least five low-inductance vias under the paddle to ground to minimize ground inductance. Use a solid ground plane wherever possible. Any cutout in the ground plane may act as slot radiator and reduce its shield effectiveness.

Keep the RF LO traces as short as possible to reduce LO radiation and susceptibility to interference.

# Complete Dual-Band Quadrature Transmitters

**Table 3. Operation Control Register (OPCTRL)**

BIT NAME	POWER-UP STATE	BIT LOCATION (0 = LSB)	FUNCTION
LO_SEL	1	15	1 selects LOL input port; 0 selects LOH port.
RCP_MAX	0	14	1 keeps RF turbo-mode current active even when frequency acquisition is achieved. This bit has no effect when RF_TURBO_CHARGE = 0. This mode is used when high operating RF charge-pump current is needed.
ICP_MAX	0	13	1 keeps IF turbo-mode current active even when frequency acquisition is achieved. This bit has no effect when IF_TURBO_CHARGE = 0. This mode is used when high operating IF charge-pump current is needed.
MODE	01	12, 11	Sets operating mode according to the following: 00 = FM mode 01 = Cellular digital mode; RFL is selected 10 = PCSHIGH mode; RFH1 is selected 11 = PCSLOW mode; RFH0 is selected
IF_BAND	0	10	1 selects IFINH and IFOUTH; 0 selects IFINL and IFOUTL. For FM mode (MODE = 00), set IF_BAND to 0.
VCO	0	9	1 selects high-band IF VCO; 0 selects low-band IF VCO.
IFG	100	8, 7, 6	3-bit IF gain control. Alters IF gain by approximately 2dB per LSB (0 to 14dB). Provides a means for adjusting balance between RF and IF gain for optimized linearity.
SIDE_BAND	1	5	When this register is 1, the upper sideband is selected (LO below RF). When this register is 0, the lower sideband is selected (LO above RF).
BUF_EN	0	4	0 turns IFLO buffer off; 1 turns IFLO buffer on.
MOD_TYPE	1	3	0 selects direct VCO modulation. (IF VCO is externally modulated and the I/Q modulator is bypassed); 1 selects quadrature modulation.
$\overline{\text{STBY}}$	1	2	0 shuts down everything except registers and serial interface.
$\overline{\text{TXSTBY}}$	1	1	0 shuts down modulator and upconverter, leaving PLLs locked and registers active. This is the programmable equivalent to the $\overline{\text{TXGATE}}$ pin.
SHDN_BIT	1	0	0 shuts down everything except serial interface, and also resets all registers to power-up state.

# Complete Dual-Band Quadrature Transmitters

MAX2366/MAX2367/MAX2368

**Table 4. Configuration Register (CONFIG)**

BIT NAME	POWER-UP STATE	BIT LOCATION (0 = LSB)	FUNCTION
IF_PLL_SHDN	1	15	0 shuts down the IF PLL. This mode is used with an external IF VCO and IF PLL.
RF_PLL_SHDN	1	14	0 shuts down the RF PLL. This mode is used with an external RF PLL.
RESERVED	0	13	Must be set to 0 for normal operation.
IQ_LEVEL	1	12	1 selects 200mV <sub>RMS</sub> input mode; 0 selects 100mV <sub>RMS</sub> input mode.
BUF_DIV	0	11	1 selects ÷2 on IFLO port; 0 bypasses the divider.
VCO_BYPASS	0	10	1 bypasses IF VCO and enables a buffered input for external VCO use.
ICP	00	9, 8	A 2-bit register sets the IF charge-pump current as follows: 00 = 175µA 01 = 235µA 10 = 350µA 11 = 465µA
RCP	00	7, 6	A 2-bit register sets the RF charge-pump current as follows: 00 = 165µA 01 = 230µA 10 = 340µA 11 = 450µA
IF_PD_POL	1	5	IF phase-detector polarity; 1 selects positive polarity (increasing tuning voltage on the VCO produces increasing frequency); 0 selects negative polarity (increasing tuning voltage on the VCO produces decreasing frequency).
RF_PD_POL	1	4	RF phase-detector polarity; 1 selects positive polarity (increasing tuning voltage on the VCO produces increasing frequency); 0 selects negative polarity (increasing voltage on the VCO produces decreasing frequency).
IF_TURBO_CHARGE	1	3	1 activates turbocharge feature, providing an additional 450µA of IF charge-pump current during frequency acquisition.
RF_TURBO_CHARGE	1	2	1 activates turbocharge feature, providing an additional 435µA of RF charge-pump current during frequency acquisition.
LD_MODE	11	1, 0	Determines output mode for LOCK detector pin as follows: 00 = test mode, LD_MODE cannot be 00 for normal operation 01 = IF PLL lock detector 10 = RF PLL lock detector 11 = logical AND of IF PLL and RF PLL lock detectors

# Complete Dual-Band Quadrature Transmitters

**Table 5. Power-Down Modes**

POWER-DOWN MODE	COMMENTS	UPCONVERTER	MODULATOR	SERIAL BUS	RF_PLL	RF PLL REGS	OPCTRL REG	IF_LO_BUFF	IF_VCO	IF_PLL	IF PLL REGS	CONFIG REG
$\overline{\text{SHDN}}$ Pin	Ultra-low shutdown current	X	X	X	X	X	X	X	X	X	X	X
$\overline{\text{IDLE}}$ Pin	$\overline{\text{IDLE}}$ is low in RX mode	X	X					X	X	X	X	
$\overline{\text{TXGATE}}$ Pin	For punctured TX mode	X	X									
RF PLL SHDN	For external RF PLL use				X	X						
IF PLL SHDN	For external IF PLL use									X	X	
TX STBY	TX is OFF, but IF and RF LOs stay locked	X	X									
REG STBY	Shuts down, but preserves registers	X	X		X			X	X	X		
REG SHDN	Serial bus is still active	X	X		X	X	X	X	X	X	X	X

X = Off

**Table 6. Register and Control Pin States for Key Operating Modes**

MODE	DESCRIPTION	OPCTRL REGISTER								CONFIG REGISTER		CONTROL PINS		
		LO_SEL	MODE	IF_BAND	VCO	MOD_TYPE	STBY	TXSTBY	SHDN_BIT	IF_PLL_SHDN	RF_PLL_SHDN	$\overline{\text{IDLE}}$	$\overline{\text{TXGATE}}$	$\overline{\text{SHDN}}$
PCS High	PCS upper half-band, RFH1 selected	0	10	1	1	1	1	1	1	1	1	H	H	H
PCS Low	PCS lower half-band, RFH0 selected	0	11	1	1	1	1	1	1	1	1	H	H	H
Cellular Digital	RFL selected	1	01	0	0	1	1	1	1	1	1	H	H	H
FM	Direct VCO modulation, RFL selected	1	00	0	0	0	1	1	1	1	1	H	H	H
PCS Idle	Listen for pages RX ON, TX OFF	0	1X	X	X	X	1	X	1	X	1	L	H	H
Cellular Idle	Listen for pages RX ON, TX OFF	1	0X	X	X	X	1	X	1	X	1	L	H	H
PCS TXGATE	Gated transmission, PCS	0	1X	1	1	1	1	X	1	1	1	H	L	H
Cellular TXGATE	Gated transmission, cellular digital	1	01	0	0	1	1	X	1	1	1	H	L	H
Sleep	Everything off	X	XX	X	X	X	X	X	X	X	X	X	X	L

X = Don't care



# Complete Dual-Band Quadrature Transmitters

**MAX2366/MAX2367/MAX2368**

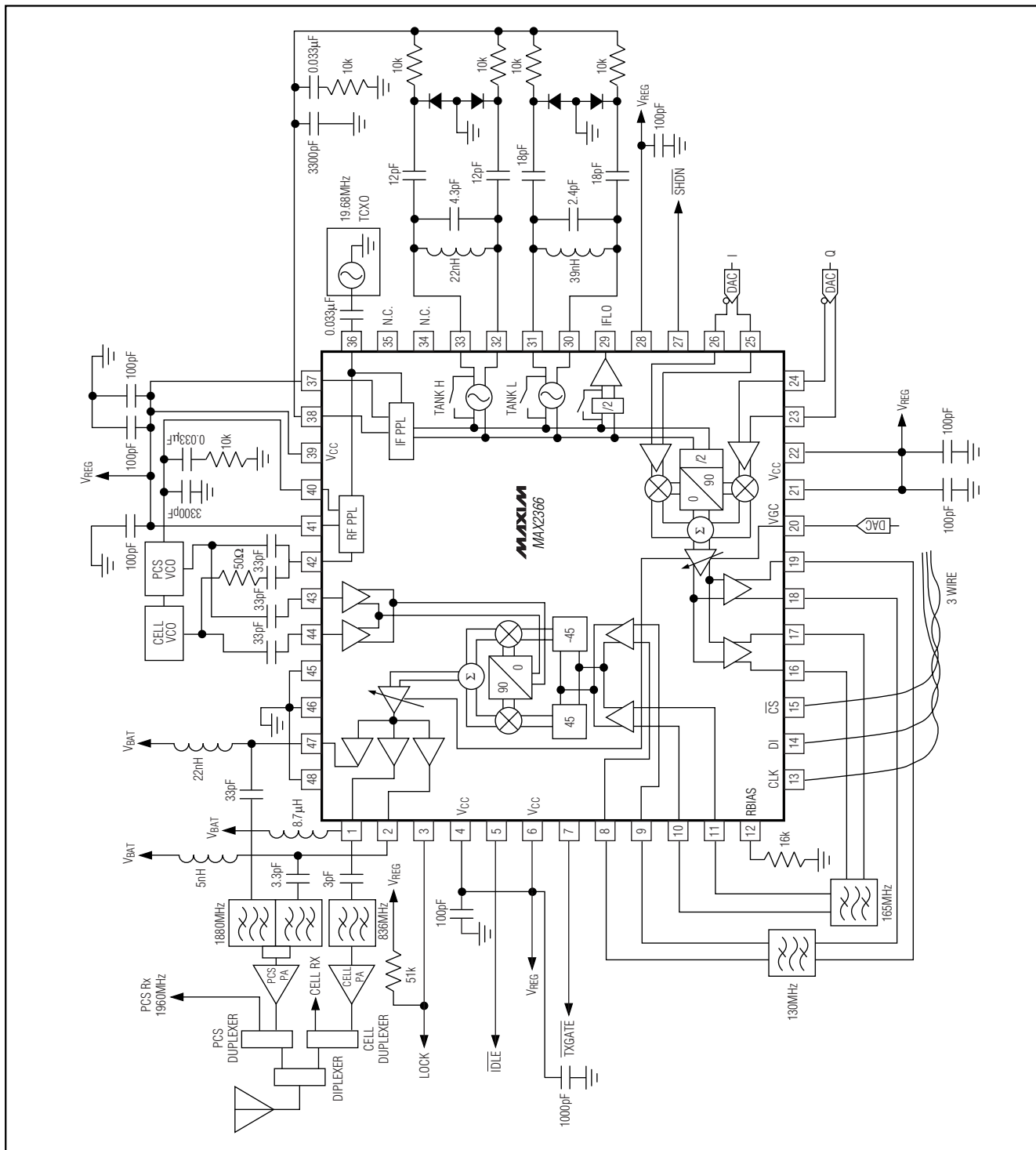

Figure 2. MAX2366 Typical Application Circuit

# Complete Dual-Band Quadrature Transmitters

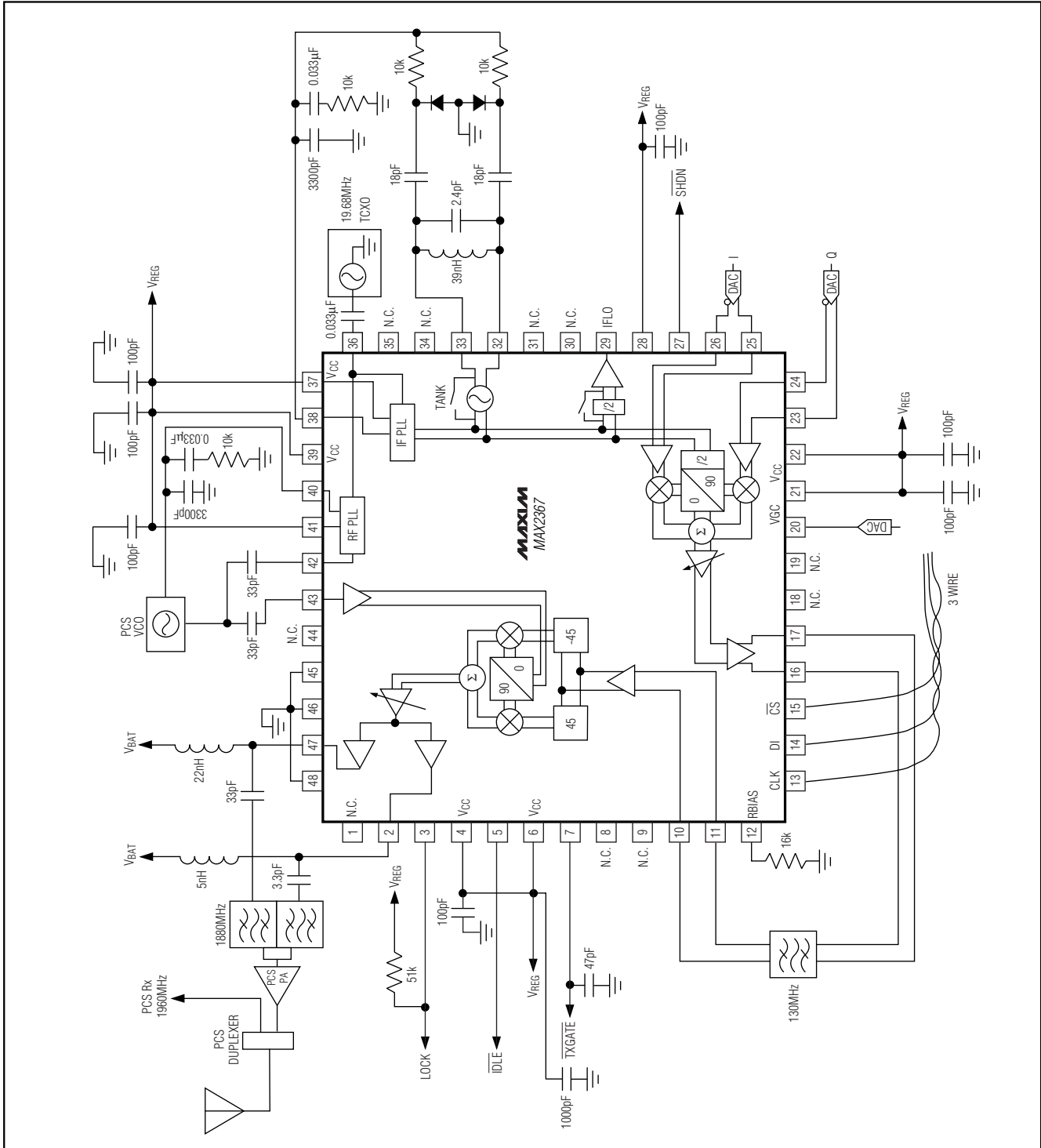

Figure 3. MAX2367 Typical Application Circuit

# Complete Dual-Band Quadrature Transmitters

MAX2366/MAX2367/MAX2368

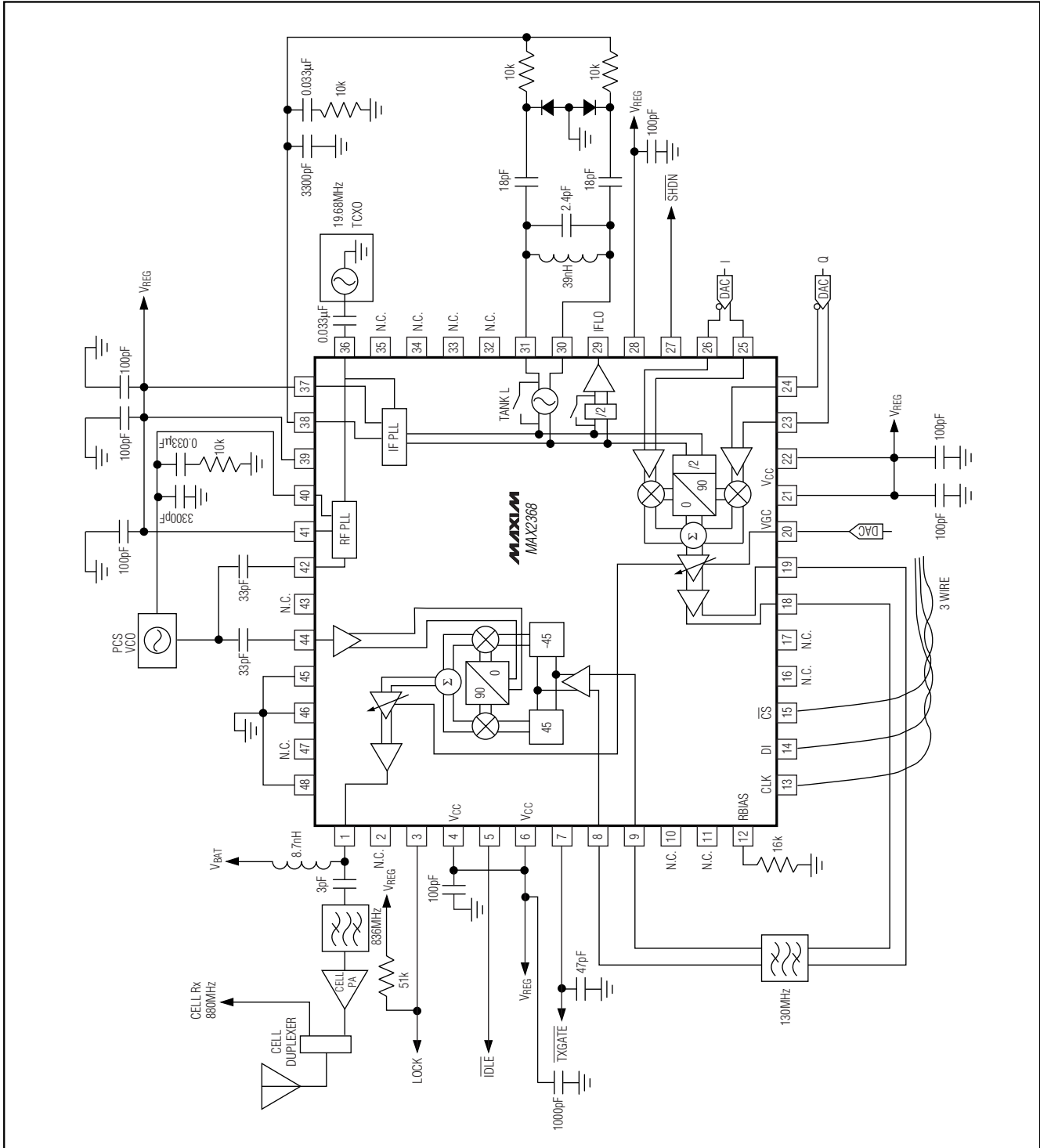

Figure 4. MAX2368 Typical Application Circuit

# Complete Dual-Band Quadrature Transmitters

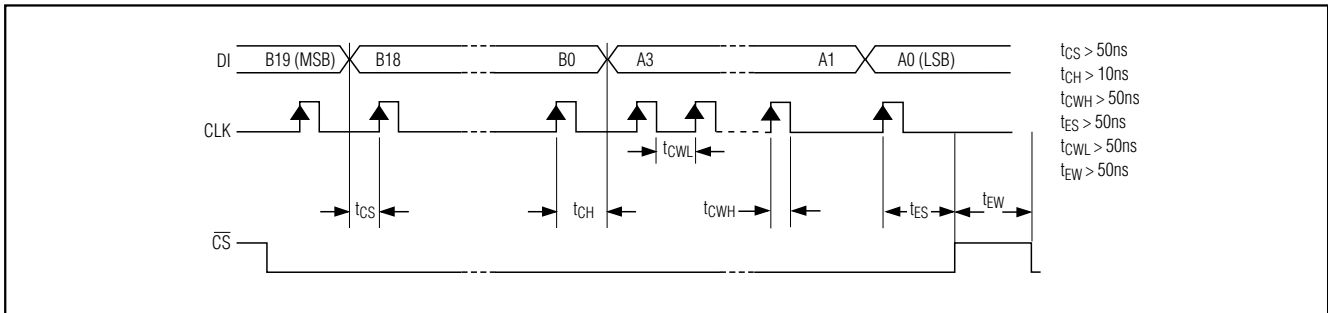

Figure 5. 3-Wire Interface Diagram

### IF Tank Design

The low-band tank (TANKL+, TANKL-) and high-band tank (TANKH+, TANKH-) are fully differential. The external tank components are shown in Figure 6. The frequency of oscillation is determined by the following equation:

$$f_{OSC} = \frac{1}{2\pi \sqrt{(C_{INT} + C_{CENT} + C_{VAR} + C_{PAR}) L}}$$

$$C_{VAR} = \frac{C_D \times C_C}{2(C_D + C_C)}$$

$C_{INT}$  = Internal capacitance of TANK port

$C_D$  = Capacitance of varactor

$C_{VAR}$  = Equivalent variable tuning capacitance

$C_{PAR}$  = Parasitic capacitance due to PC board pads and traces

$C_{CENT}$  = External capacitor for centering oscillation frequency

$C_C$  = External coupling capacitor to the varactor

Internal to the IC, the charge pump will have a leakage of less than 10nA. This is equivalent to a 300MΩ shunt resistor. The charge-pump output must see an extremely high DC resistance of greater than 300MΩ. This will minimize charge-pump spurs at the comparison frequency. Make sure there is no solder flux under the varactor or loop filter.

### Layout Issues

The MAX2366/MAX2367/MAX2368 EV kit can be used as a starting point for layout. For best performance, take into consideration power-supply issues, as well as the RF, LO, and IF layout.

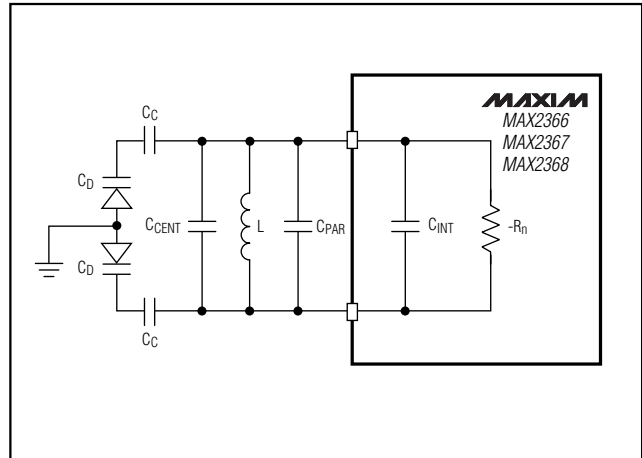

Figure 6. Tank Port Oscillator

### Power-Supply Layout

To minimize coupling between different sections of the IC, the ideal power-supply layout is a star configuration, which has a large decoupling capacitor at a central VCC node. The VCC traces branch out from this node, each going to a separate VCC node in the MAX2366/MAX2367/MAX2368 circuit. At the end of each trace is a bypass capacitor with impedance to ground less than 1Ω at the frequency of interest. This arrangement provides local decoupling at each VCC pin. Use at least one via per bypass capacitor for a low-inductance ground connection.

### Matching Network Layout

The layout of a matching network can be very sensitive to parasitic circuit elements. To minimize parasitic inductance, keep all traces short and place components as close to the IC as possible. To minimize parasitic capacitance, a cutout in the ground plane (and

# Complete Dual-Band Quadrature Transmitters

any other planes) below the matching network components can be used.

On the high-impedance ports (e.g., IF inputs and outputs), keep traces short to minimize shunt capacitance.

## Tank Layout

Keep the traces coming out of the tank short to reduce series inductance and shunt capacitance. Keep the inductor pads and coupling capacitor pads small to minimize stray shunt capacitance.

## Selector Guide

PART	IF RANGE (MHz)	RF LO RANGE (MHz)	RF RANGE (MHz)
MAX2366	120 to 235	800 to 1150	800 to 1000
	120 to 300	1400 to 2300	1700 to 2000
MAX2367	120 to 300	1400 to 2300	1700 to 2000
MAX2368	120 to 235	800 to 1150	800 to 1000

MAX2366/MAX2367/MAX2368

# Complete Dual-Band Quadrature Transmitters

## Pin Configurations (continued)

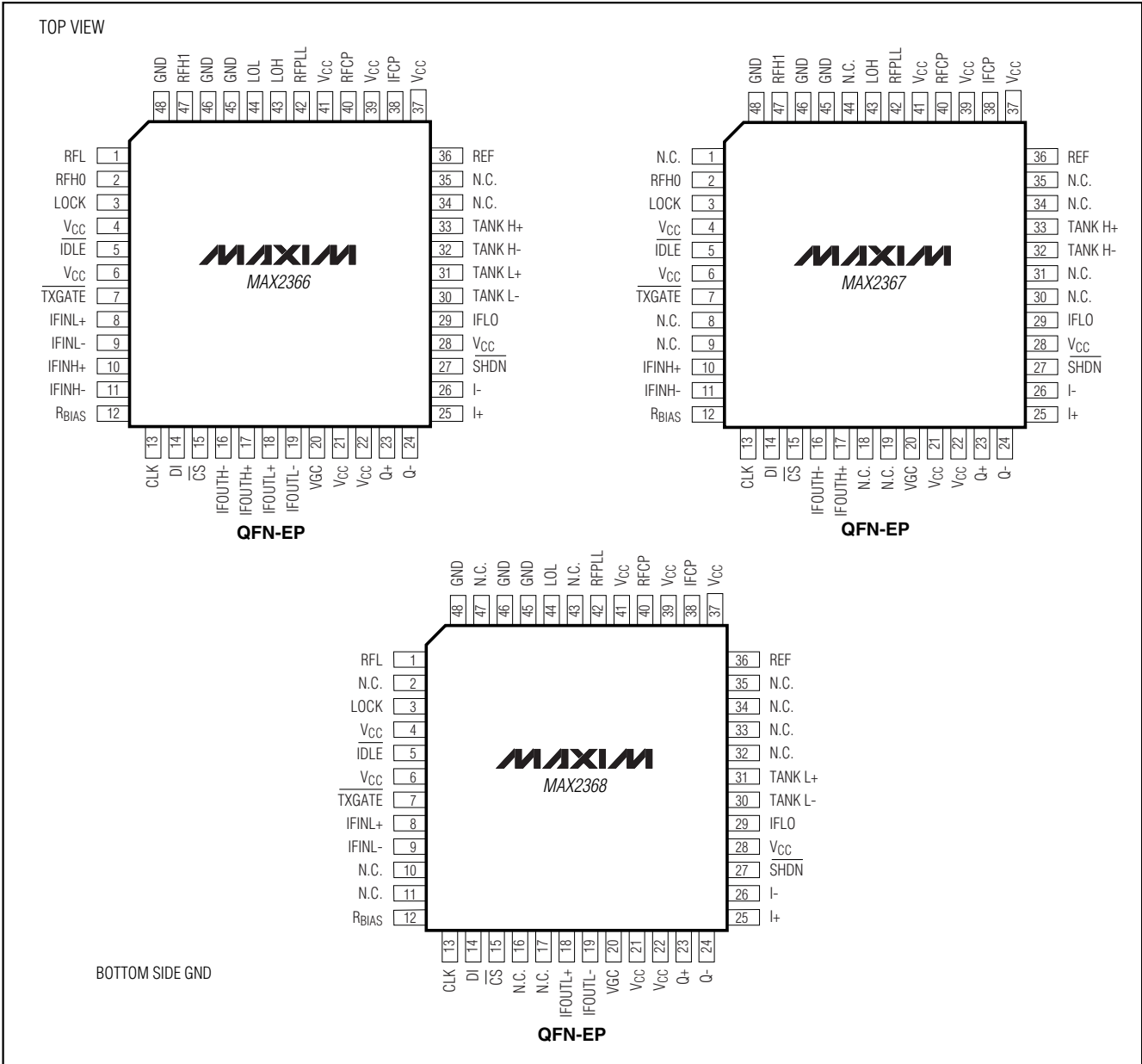

## Package Information

For the latest package outline information, go to [www.maxim-ic.com/packages](http://www.maxim-ic.com/packages).

Maxim cannot assume responsibility for use of any circuitry other than circuitry entirely embodied in a Maxim product. No circuit patent licenses are implied. Maxim reserves the right to change the circuitry and specifications without notice at any time.

22 **Maxim Integrated Products, 120 San Gabriel Drive, Sunnyvale, CA 94086 408-737-7600**