



SERIES VM100  
3/2 N.C. MECHANICAL VALVE 1/8

- ✓ 3/2 normally closed valve (& 5/3 twist selector)
- ✓ 17 different actuators
- ✓ Cv 0.14 flow

TECHNICAL SPECIFICATIONS

Piping	Side piping
Fluid	Air
Operating pressure	10 Torr ~ 9.9 Bar
Ambient and fluid temperature	5 ~ 60°C
Effective orifice (Cv factor)	2.5mm <sup>2</sup> (0.14)
Lubrication	Non lube
Port size	1/8 (side piping)

KEY TO DIMENSIONAL TABLES

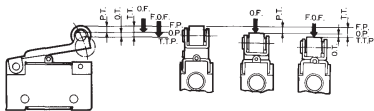

- F.O.F. (Full Operating Force) ... Required force to total travel position
- P.T. (Pre Travel) ... From free position to initial valve opening position
- O.T. (Over Travel) ... From initial valve opening position to total travel position
- T.T. (Total Travel) ... From free position to total travel position

DIMENSIONS  
VM100 BASIC VALVE

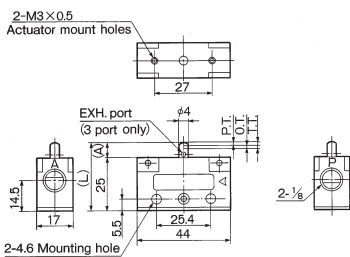

F.O.F*	20N
P.T.	1.5mm
O.T.	1.5mm
T.T.	3mm

\*5 Bar supply

How To ORDER  
VM100 ACTUATOR ONLY

..... PART NO. APPLICATION

MECHANICAL OPERATION

- Basic .....
- Roller lever ..... Polyacetal roller
- One way trip ..... Polyacetal roller
- Straight plunger ..... VM-05B .....
- Roller plunger ..... VM-06B ..... Polyacetal roller
- Cross roller plunger ..... VM-07B ..... Polyacetal roller
- Cross roller plunger ..... VM-06BS ..... Hardened Steel Roller

MANUAL OPERATION

- Toggle ..... VM-08B .....
- Push Button-Mushroom ... VM-30AR ... Red
- Push Button-Mushroom ... VM-30AB ... Black
- Push Button-Mushroom ... VM-30AG ... Green
- Push button-Extended ..... VM-32AR ... Red
- Push button-Extended ..... VM-32AB ... Black
- Push button-Extended ..... VM-32AG ... Green
- Push button-Flush ..... VM-33A .....
- Twist selector ..... VM-34AR ... Red
- Twist selector ..... VM-34AB ... Black
- Twist selector ..... VM-34AG ... Green
- Key selector ..... VM-36A .....
- 5/3 twist selector ..... Red
- 5/3 twist selector ..... Black
- 5/3 twist selector ..... Green

How To ORDER  
VM100 VALVE

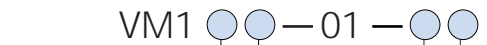

- VALVE TYPE
- 3 ..... 3/2
  - 5 ..... 5/3 (Actuator 35 only)

- PLUNGER LENGTH
- 0 ..... Standard
  - 1 ..... Short (for Actuator Types 00,01,02,35)

- ACTUATOR
- 00 ... Basic type
  - 01 ... Roller lever
  - 01S ... Roller lever hard steel roller
  - 02 ... One way trip
  - 02S ... One way trip hard steel roller
  - 05 ... Straight plunger
  - 06 ... Roller plunger
  - 06S ... Roller plunger hard steel roller
  - 07 ... Cross roller plunger
  - 07S ... Cross roller plunger hard steel roller
  - 08 ... Toggle
  - 30 ... Push Button-Mushroom
  - 32 ... Push button-Extended
  - 33 ... Push button-Flush
  - 34 ... Twist selector
  - 35 ... 5/3 twist selector
  - 36 ... Key selector

- PUSH BUTTON COLOUR
- R ..... Red
  - G ..... Green
  - B ..... Black

SYMBOLS  
VM100 BASIC VALVE

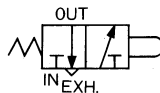

If these valves are used for guarding or safety interlock systems, installation and application should be as per BS5304: 1988. Careful note should be taken of the operating principles and design of different ranges of mechanical valves when specifying valves for safety related systems.

STOCKED PRODUCTS  
FOR A LIST OF STOCKED PRODUCTS,  
PLEASE SEE THE CURRENT SMC PRICE LIST

MORE DIMENSIONS  
SEE NEXT PAGE

## DIMENSIONS VM100 ROLLER LEVER

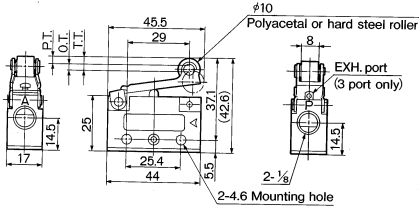

F.O.F*	10N
P.T.	3.2mm
O.T.	2.3mm
T.T.	5.5mm

\*5 Bar supply

## DIMENSIONS VM100 ONE WAY TRIP

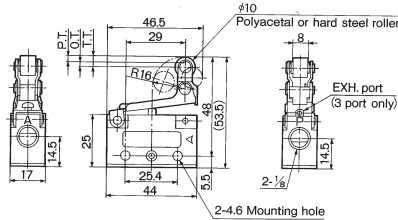

F.O.F*	10N
P.T.	3.2mm
O.T.	2.3mm
T.T.	5.5mm

\*5 Bar supply

## DIMENSIONS VM100 STRAIGHT PLUNGER

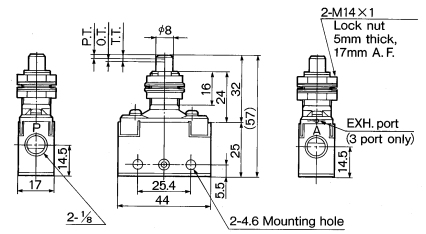

Panel mount hole

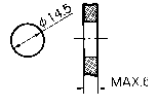

F.O.F*	23N
P.T.	2mm
O.T.	1.5mm
T.T.	3.5mm

\*5 Bar supply

## SYMBOLS VM100 ROLLER LEVER

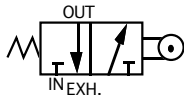

## SYMBOLS VM100 ONE WAY TRIP

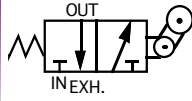

## SYMBOLS VM100 STRAIGHT PLUNGER

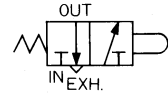

## DIMENSIONS VM100 ROLLER PLUNGER

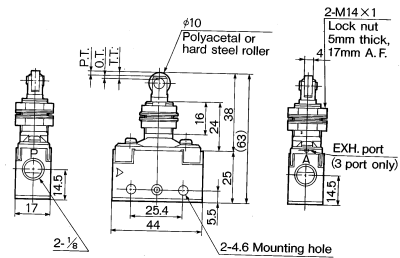

Panel mount hole

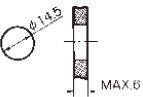

F.O.F*	23N
P.T.	2mm
O.T.	1.5mm
T.T.	3.5mm

\*5 Bar supply

## DIMENSIONS VM100 CROSS ROLLER PLUNGER

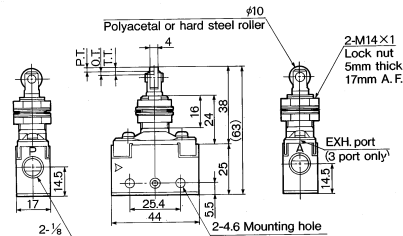

Panel mount hole

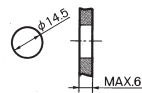

F.O.F*	23N
P.T.	2mm
O.T.	1.5mm
T.T.	3.5mm

\*5 Bar supply

## DIMENSIONS VM100 TOGGLE LEVER

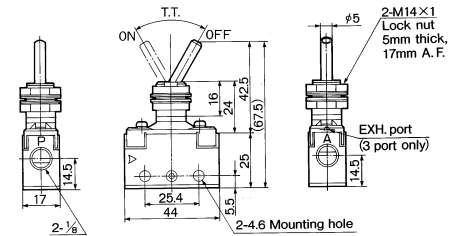

Panel mount hole

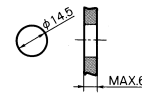

F.O.F*	10N
T.T.	60°

\*5 Bar supply

## SYMBOLS VM100 ROLLER PLUNGER

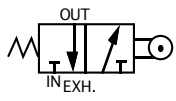

## SYMBOLS VM100 CROSS ROLLER PLUNGER

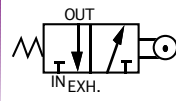

## SYMBOLS VM100 TOGGLE LEVER

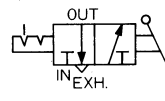

SEE INSIDE FRONT COVER FOR  
DETAILS OF YOUR LOCAL SALES OFFICE



FOR FURTHER TECHNICAL  
DETAILS ON THIS  
PRODUCT REQUEST  
CATALOGUE REFERENCE  
E104

**DIMENSIONS**  
VM100 PUSH BUTTON-MUSHROOM

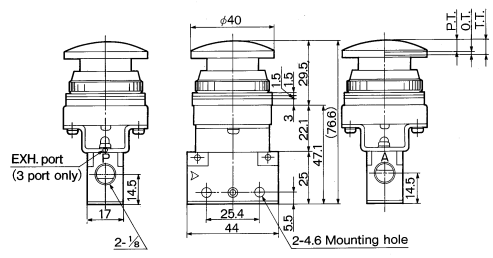

<b>Panel mount hole</b>	F.O.F*	21N
	P.T.	5.4mm
	O.T.	1.6mm
	T.T.	7mm

\*5 Bar supply

**DIMENSIONS**  
VM100 PUSH BUTTON-EXTENDED

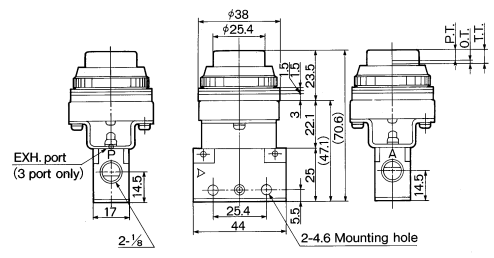

<b>Panel mount hole</b>	F.O.F*	21N
	P.T.	5.4mm
	O.T.	1.6mm
	T.T.	7mm

\*5 Bar supply

**DIMENSIONS**  
VM100 PUSH BUTTON-FLUSH

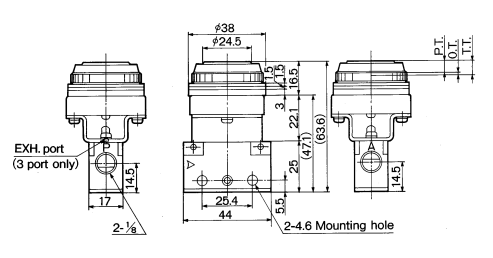

<b>Panel mount hole</b>	F.O.F*	21N
	P.T.	5.4mm
	O.T.	1.6mm
	T.T.	7mm

\*5 Bar supply

**SYMBOLS**  
VM100 PUSH BUTTON-MUSHROOM

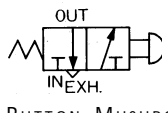

**SYMBOLS**  
VM100 PUSH BUTTON-EXTENDED

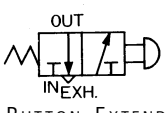

**SYMBOLS**  
VM100 PUSH BUTTON-FLUSH

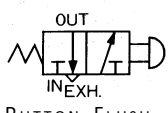

**DIMENSIONS**  
VM100 TWIST SELECTOR-2 POSITION

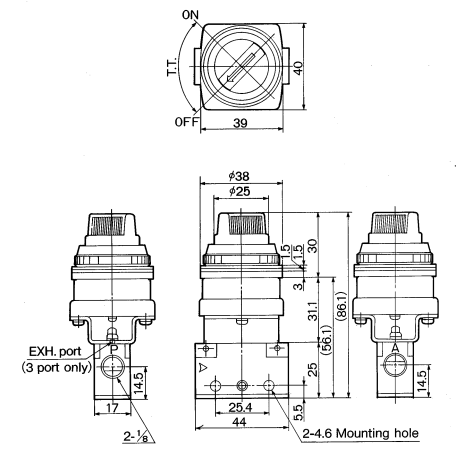

<b>Panel mount hole</b>	F.O.F*	15N
	T.T.	90°

\*5 Bar supply

**DIMENSIONS**  
VM100 KEY SELECTOR-2 POSITION

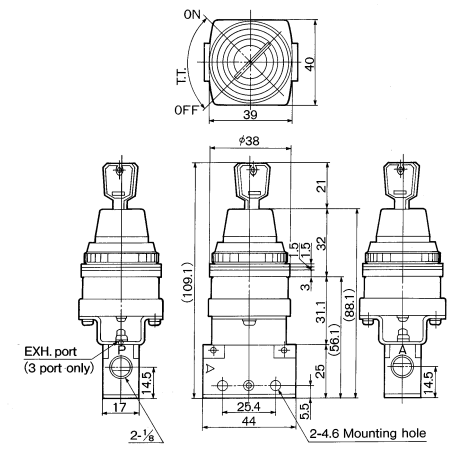

<b>Panel mount hole</b>	F.O.F*	15N
	T.T.	90°

\*5 Bar supply

**DIMENSIONS**  
VM100 5/3 TWIST SELECTOR

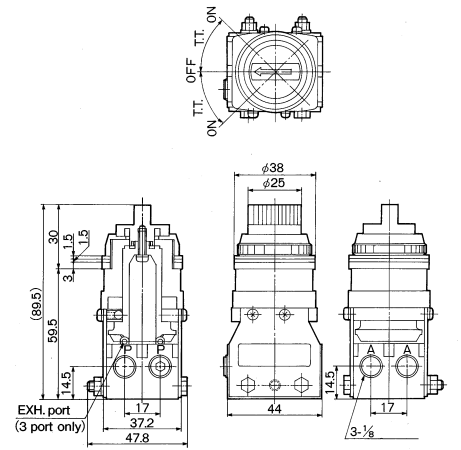

<b>Panel mount hole</b>	F.O.F*	15N
	T.T.	45°

\*5 Bar supply

**SYMBOLS**  
VM100 TWIST SELECTOR-2 POSITION

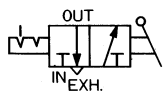

**SYMBOLS**  
VM100 KEY SELECTOR-2 POSITION

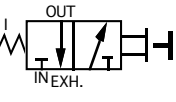

**SYMBOLS**  
VM100 5/3 TWIST SELECTOR

