

## POWER MOS 7™

Power MOS 7™ is a new generation of low loss, high voltage, N-Channel enhancement mode power MOSFETS. Both conduction and switching losses are addressed with Power MOS 7™ by significantly lowering  $R_{DS(ON)}$  and  $Q_g$ . Power MOS 7™ combines lower conduction and switching losses along with exceptionally fast switching speeds inherent with APT's patented metal gate structure.

- Lower Input Capacitance
- Lower Miller Capacitance
- Lower Gate Charge,  $Q_g$
- Increased Power Dissipation
- Easier To Drive
- PFC "Boost" Configuration

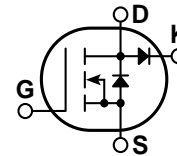

### MAXIMUM RATINGS

All Ratings:  $T_C = 25^\circ\text{C}$  unless otherwise specified.

| Symbol         | Parameter  | APT50M75JLLU2 | UNIT                |
|----------------|--|---------------|---------------------|
| $V_{DSS}$      | Drain-Source Voltage   | 500           | Volts               |
| $I_D$          | Continuous Drain Current @ $T_C = 25^\circ\text{C}$            | 51            | Amps                |
| $I_{DM}$       | Pulsed Drain Current <sup>①</sup>                              | 204           |                     |
| $V_{GS}$       | Gate-Source Voltage Continuous                                 | $\pm 30$      | Volts               |
| $V_{GSM}$      | Gate-Source Voltage Transient                                  | $\pm 40$      |                     |
| $P_D$          | Total Power Dissipation @ $T_C = 25^\circ\text{C}$             | 465           | Watts               |
|                | Linear Derating Factor   | 3.72          | W/ $^\circ\text{C}$ |
| $T_J, T_{STG}$ | Operating and Storage Junction Temperature Range               | -55 to 150    | $^\circ\text{C}$    |
| $T_L$          | Lead Temperature: 0.063" from Case for 10 Sec.                 | 300           |                     |
| $I_{AR}$       | Avalanche Current <sup>①</sup> (Repetitive and Non-Repetitive) | 51            | Amps                |
| $E_{AR}$       | Repetitive Avalanche Energy <sup>①</sup>                       | 50            | mJ                  |
| $E_{AS}$       | Single Pulse Avalanche Energy <sup>④</sup>                     | 2500          |                     |

### STATIC ELECTRICAL CHARACTERISTICS

| Symbol       | Characteristic / Test Conditions   | MIN | TYP | MAX       | UNIT          |
|--------------|--|-----|-----|-----------|---------------|
| $BV_{DSS}$   | Drain-Source Breakdown Voltage ( $V_{GS} = 0V, I_D = 250\mu\text{A}$ )                             | 500 |     |           | Volts         |
| $I_{D(on)}$  | On State Drain Current <sup>②</sup> ( $V_{DS} > I_{D(on)} \times R_{DS(on)}$ Max, $V_{GS} = 10V$ ) | 51  |     |           | Amps          |
| $R_{DS(on)}$ | Drain-Source On-State Resistance <sup>②</sup> ( $V_{GS} = 10V, 0.5 I_{D[Cont.]}$ )                 |     |     | 0.075     | Ohms          |
| $I_{DSS}$    | Zero Gate Voltage Drain Current ( $V_{DS} = V_{DSS}, V_{GS} = 0V$ )                                |     |     | 100       | $\mu\text{A}$ |
|              | Zero Gate Voltage Drain Current ( $V_{DS} = 0.8 V_{DSS}, V_{GS} = 0V, T_C = 125^\circ\text{C}$ )   |     |     | 500       |               |
| $I_{GSS}$    | Gate-Source Leakage Current ( $V_{GS} = \pm 30V, V_{DS} = 0V$ )                                    |     |     | $\pm 100$ | nA            |
| $V_{GS(th)}$ | Gate Threshold Voltage ( $V_{DS} = V_{GS}, I_D = 2.5\text{mA}$ )                                   | 3   |     | 5         | Volts         |

 **CAUTION:** These Devices are Sensitive to Electrostatic Discharge. Proper Handling Procedures Should Be Followed.

APT Website - <http://www.advancedpower.com>

| Symbol       | Characteristic               | Test Conditions  | MIN | TYP  | MAX | UNIT |
|--------------|------------------------------|--|-----|------|-----|------|
| $C_{iss}$    | Input Capacitance            | $V_{GS} = 0V$<br>$V_{DS} = 25V$<br>$f = 1\text{ MHz}$  |     | 5800 |     | pF   |
| $C_{oss}$    | Output Capacitance           |  |     | 1200 |     |      |
| $C_{rss}$    | Reverse Transfer Capacitance |  |     | 90   |     |      |
| $Q_g$        | Total Gate Charge ③          | $V_{GS} = 10V$<br>$V_{DD} = 0.5 V_{DSS}$<br>$I_D = I_{D[Cont.]} @ 25^\circ C$                      |     | 145  |     | nC   |
| $Q_{gs}$     | Gate-Source Charge           |  |     | 38   |     |      |
| $Q_{gd}$     | Gate-Drain ("Miller") Charge |  |     | 66   |     |      |
| $t_{d(on)}$  | Turn-on Delay Time           | $V_{GS} = 15V$<br>$V_{DD} = 0.5 V_{DSS}$<br>$I_D = I_{D[Cont.]} @ 25^\circ C$<br>$R_G = 0.6\Omega$ |     | 17   |     | ns   |
| $t_r$        | Rise Time                    |  |     | 14   |     |      |
| $t_{d(off)}$ | Turn-off Delay Time          |  |     | 38   |     |      |
| $t_f$        | Fall Time                    |  |     | 5    |     |      |

SOURCE-DRAIN DIODE RATINGS AND CHARACTERISTICS

| Symbol   | Characteristic / Test Conditions  | MIN | TYP  | MAX | UNIT    |
|----------|---|-----|------|-----|---------|
| $I_S$    | Continuous Source Current (Body Diode)                                  |     |      | 51  | Amps    |
| $I_{SM}$ | Pulsed Source Current ① (Body Diode)                                    |     |      | 204 |         |
| $V_{SD}$ | Diode Forward Voltage ② ( $V_{GS} = 0V, I_S = -I_{D[Cont.]}$ )          |     |      | 1.3 | Volts   |
| $t_{rr}$ | Reverse Recovery Time ( $I_S = -I_{D[Cont.]}, di_S/dt = 100A/\mu s$ )   |     | 620  |     | ns      |
| $Q_{rr}$ | Reverse Recovery Charge ( $I_S = -I_{D[Cont.]}, di_S/dt = 100A/\mu s$ ) |     | 14.7 |     | $\mu C$ |
| $dv/dt$  | Peak Diode Recovery $dv/dt$ ⑤   |     |      | 8   | V/ns    |

THERMAL CHARACTERISTICS

| Symbol          | Characteristic      | MIN | TYP | MAX  | UNIT         |
|-----------------|---------------------|-----|-----|------|--------------|
| $R_{\theta JC}$ | Junction to Case    |     |     | 0.27 | $^\circ C/W$ |
| $R_{\theta JA}$ | Junction to Ambient |     |     | 40   |              |

① Repetitive Rating: Pulse width limited by maximum junction temperature.

② Pulse Test: Pulse width < 380  $\mu s$ , Duty Cycle < 2%

③ See MIL-STD-750 Method 3471

④ Starting  $T_j = +25^\circ C$ ,  $L = 1.92mH$ ,  $R_G = 25\Omega$ , Peak  $I_L = 51A$

⑤  $dv/dt$  numbers reflect the limitations of the test circuit rather than the device itself.  $I_S \leq -I_{D[Cont.]}$   $di/dt \leq 700A/\mu s$   $V_R \leq V_{DSS}$   $T_j \leq 150^\circ C$

APT Reserves the right to change, without notice, the specifications and information contained herein.

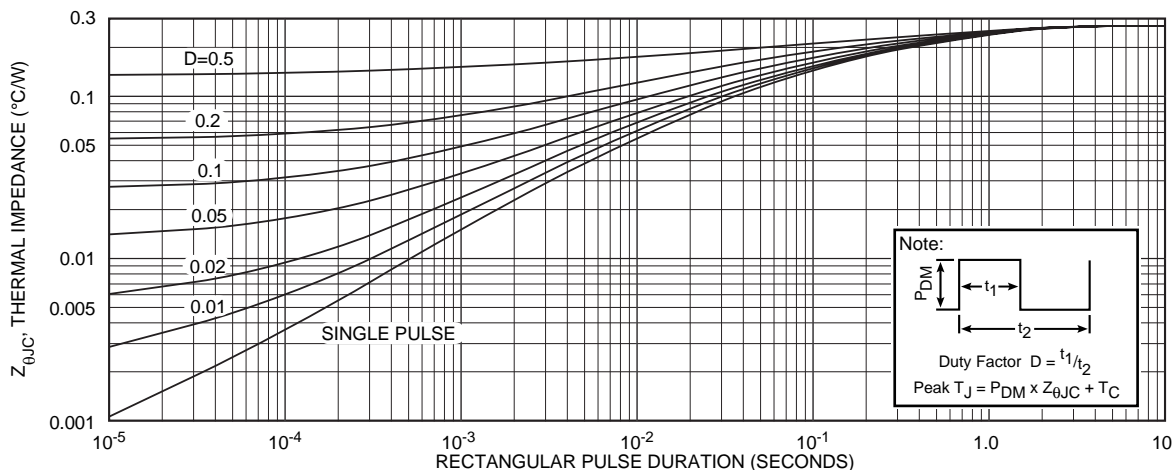

FIGURE 1, MAXIMUM EFFECTIVE TRANSIENT THERMAL IMPEDANCE, JUNCTION-TO-CASE vs PULSE DURATION

**MAXIMUM RATINGS (UltraFast Recovery Diode)**All Ratings:  $T_C = 25^\circ\text{C}$  unless otherwise specified.

| Symbol         | Characteristic / Test Conditions   | APT50M75JLLU2 | UNIT             |
|----------------|--|---------------|------------------|
| $V_R$          | Maximum D.C. Reverse Voltage   | 600           | Volts            |
| $V_{RRM}$      | Maximum Peak Repetitive Reverse Voltage  |               |                  |
| $V_{RWM}$      | Maximum Working Peak Reverse Voltage   |               |                  |
| $I_F(AV)$      | Maximum Average Forward Current ( $T_C = 80^\circ\text{C}$ , Duty Cycle = 0.5) | 30            | Amps             |
| $I_F(RMS)$     | RMS Forward Current  | 60            |                  |
| $I_{FSM}$      | Non-Repetitive Forward Surge Current ( $T_J = 45^\circ\text{C}$ , 8.3mS)       | 320           |                  |
| $T_J, T_{STG}$ | Operating and Storage Temperature Range  | -55 to 150    | $^\circ\text{C}$ |
| $T_L$          | Lead Temperature: 0.063" from Case for 10 Sec.                                 | 300           |                  |

**STATIC ELECTRICAL CHARACTERISTICS**

| Symbol   | Characteristic / Test Conditions          | MIN  | TYP | MAX | UNIT          |
|----------|---|--|-----|-----|---------------|
| $V_F$    | Maximum Forward Voltage                   | $I_F = 30\text{A}$                           |     | 1.8 | Volts         |
|          |   | $I_F = 60\text{A}$                           |     | 1.5 |               |
|          |   | $I_F = 30\text{A}, T_J = 150^\circ\text{C}$  |     | 1.6 |               |
| $I_{RM}$ | Maximum Reverse Leakage Current           | $V_R = V_R$ Rated                            |     | 250 | $\mu\text{A}$ |
|          |   | $V_R = V_R$ Rated, $T_J = 125^\circ\text{C}$ |     | 500 |               |
| $C_T$    | Junction Capacitance, $V_R = 200\text{V}$ |  | 40  |     | pF            |

**DYNAMIC CHARACTERISTICS**

| Symbol     | Characteristic  | MIN | TYP                        | MAX | UNIT       |
|------------|---|-----|----------------------------|-----|------------|
| $t_{rr1}$  | Reverse Recovery Time, $I_F = 1.0A$ , $di_F/dt = -15A/\mu S$ , $V_R = 30V$ , $T_J = 25^\circ C$ |     | 50                         | 65  | nS         |
| $t_{rr2}$  | Reverse Recovery Time   |     | $T_J = 25^\circ C$<br>50   |     |            |
| $t_{rr3}$  | $I_F = 30A$ , $di_F/dt = -240A/\mu S$ , $V_R = 350V$  |     | $T_J = 100^\circ C$<br>80  |     |            |
| $t_{fr1}$  | Forward Recovery Time   |     | $T_J = 25^\circ C$<br>155  |     |            |
| $t_{fr2}$  | $I_F = 30A$ , $di_F/dt = 240A/\mu S$ , $V_R = 350V$   |     | $T_J = 100^\circ C$<br>155 |     |            |
| $I_{RRM1}$ | Reverse Recovery Current  |     | $T_J = 25^\circ C$<br>4    | 10  | Amps       |
| $I_{RRM2}$ | $I_F = 30A$ , $di_F/dt = -240A/\mu S$ , $V_R = 350V$  |     | $T_J = 100^\circ C$<br>7.5 | 15  |            |
| $Q_{rr1}$  | Recovery Charge   |     | $T_J = 25^\circ C$<br>100  |     | nC         |
| $Q_{rr2}$  | $I_F = 30A$ , $di_F/dt = -240A/\mu S$ , $V_R = 350V$  |     | $T_J = 100^\circ C$<br>300 |     |            |
| $V_{fr1}$  | Forward Recovery Voltage  |     | $T_J = 25^\circ C$<br>5    |     | Volts      |
| $V_{fr2}$  | $I_F = 30A$ , $di_F/dt = 240A/\mu S$ , $V_R = 350V$   |     | $T_J = 100^\circ C$<br>5   |     |            |
| diM/dt     | Rate of Fall of Recovery Current  |     | $T_J = 25^\circ C$<br>400  |     | A/ $\mu S$ |
|            | $I_F = 30A$ , $di_F/dt = -240A/\mu S$ , $V_R = 350V$ (See Figure 10)                            |     | $T_J = 100^\circ C$<br>200 |     |            |

**THERMAL AND MECHANICAL CHARACTERISTICS**

| Symbol          | Characteristic / Test Conditions       | MIN | TYP  | MAX  | UNIT         |
|-----------------|--|-----|------|------|--------------|
| $R_{\theta JC}$ | Junction-to-Case Thermal Resistance    |     |      | 0.90 | $^\circ C/W$ |
| $R_{\theta JA}$ | Junction-to-Ambient Thermal Resistance |     |      | 20   |              |
| $W_T$           | Package Weight                         |     | 1.06 |      | oz.          |
|                 |  |     | 30   |      | gm.          |

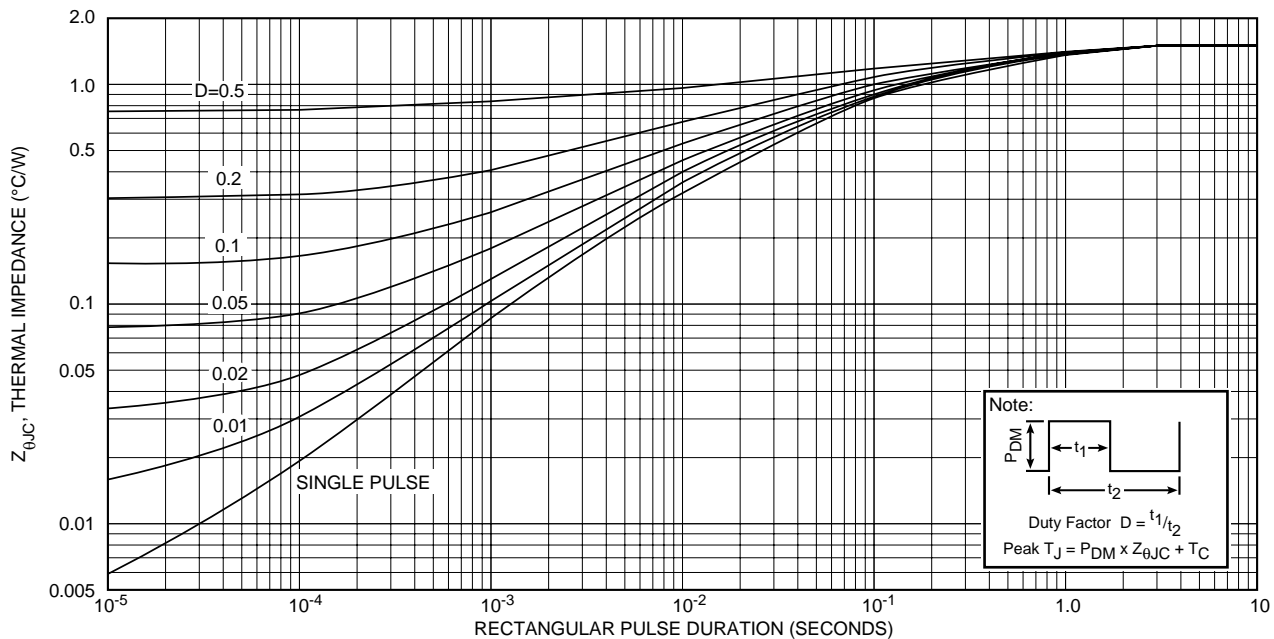

FIGURE 14, MAXIMUM EFFECTIVE TRANSIENT THERMAL IMPEDANCE, JUNCTION-TO-CASE vs PULSE DURATION

APT50M75JLLU2

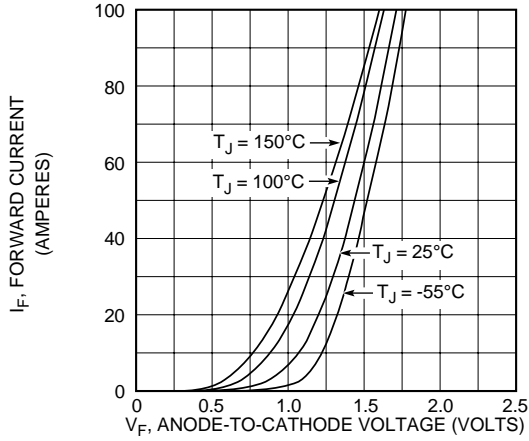

Figure 15, Forward Voltage Drop vs Forward Current

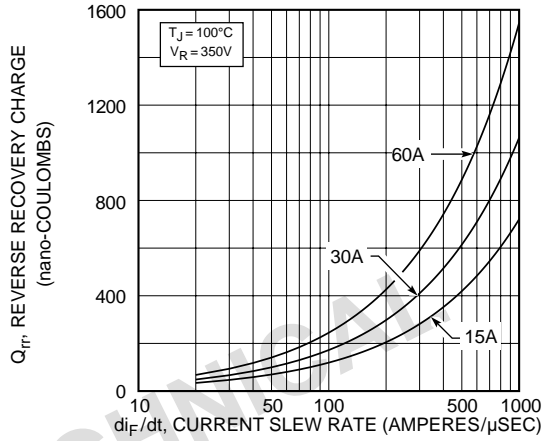

Figure 16, Reverse Recovery Charge vs Current Slew Rate

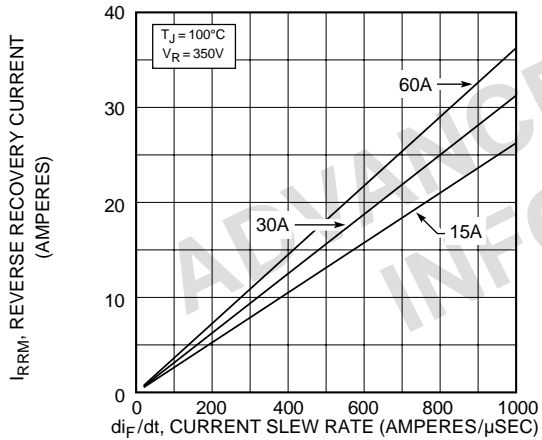

Figure 17, Reverse Recovery Current vs Current Slew Rate

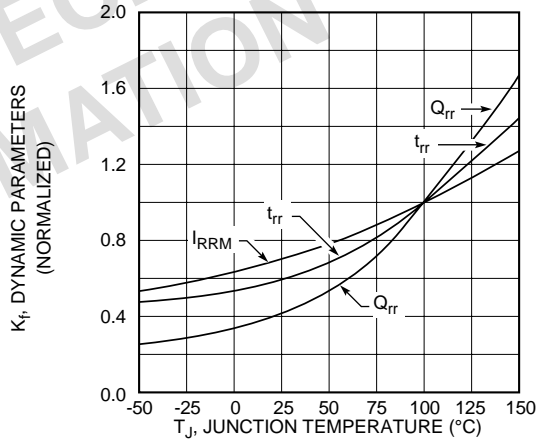

Figure 18, Dynamic Parameters vs Junction Temperature

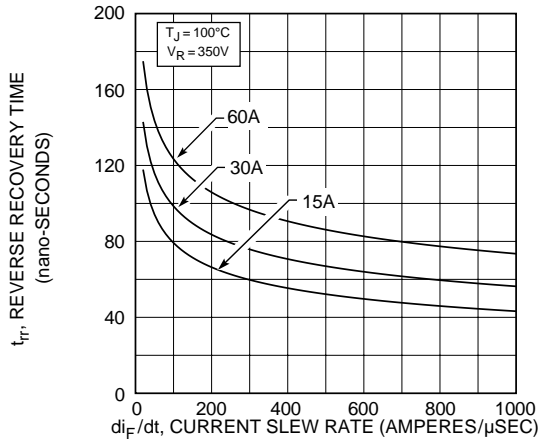

Figure 19, Reverse Recovery Time vs Current Slew Rate

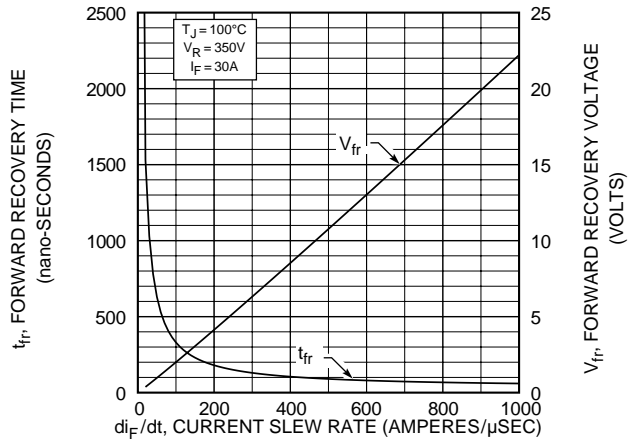

Figure 20, Forward Recovery Voltage/Time vs Current Slew Rate

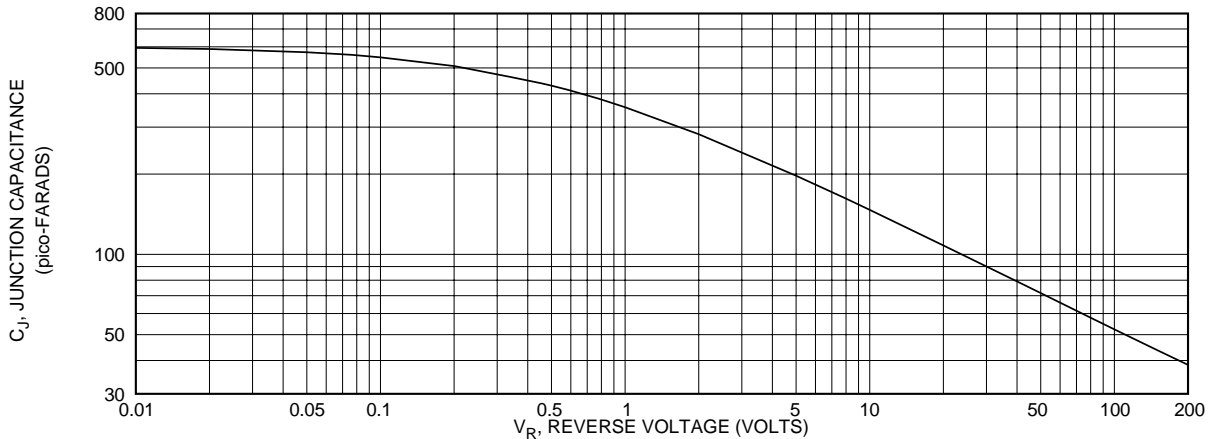

Figure 21, Junction Capacitance vs Reverse Voltage

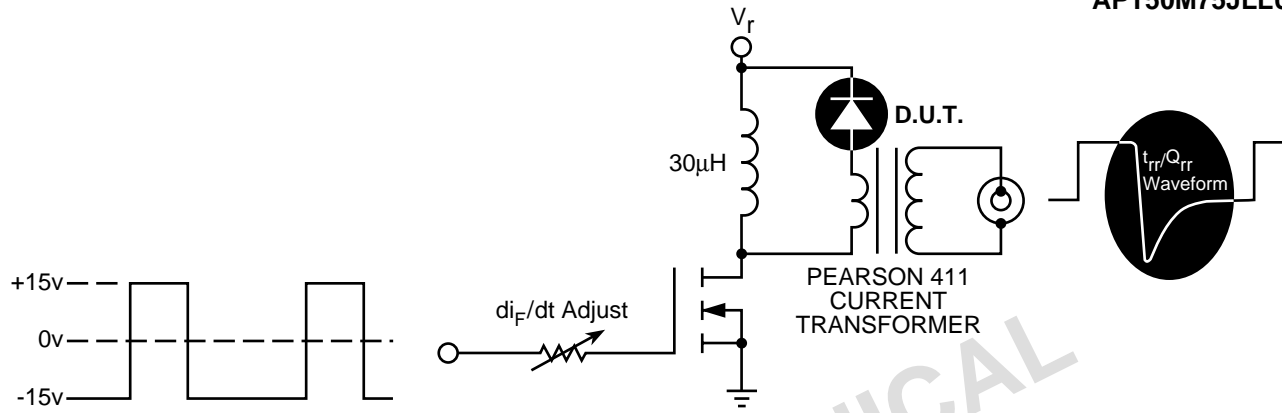

Figure 22, Diode Reverse Recovery Test Circuit and Waveforms

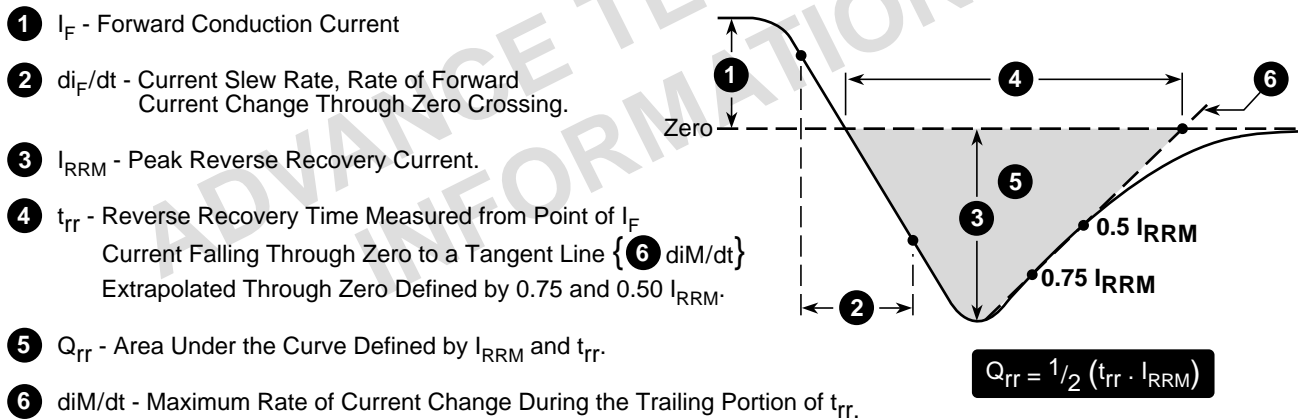
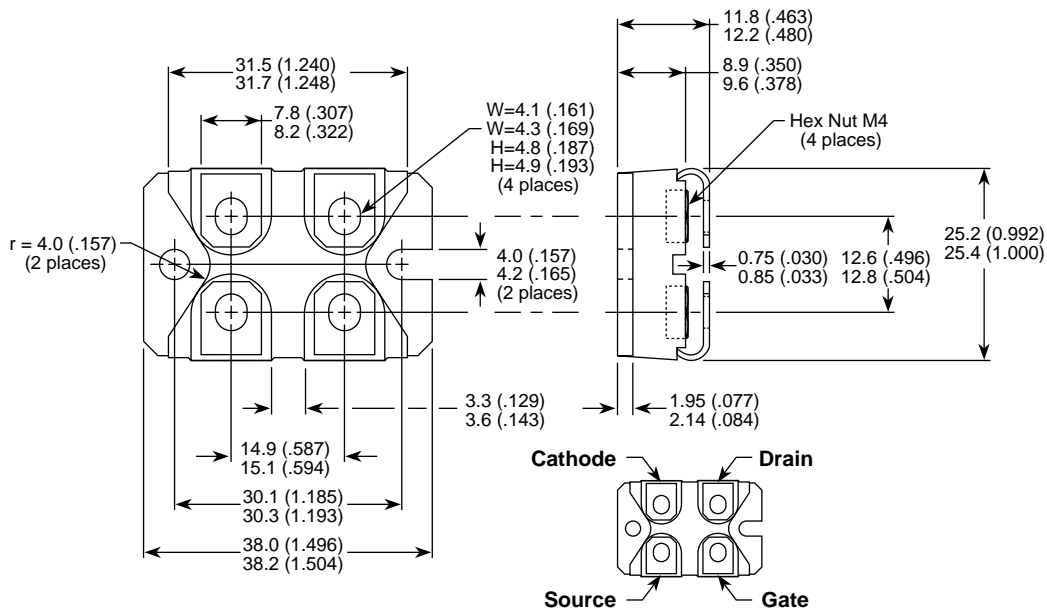

Figure 23, Diode Reverse Recovery Waveform and Definitions

SOT-227 (ISOTOP®) Package Outline



Dimensions in Millimeters and (Inches)