

2-Way Power Divider

P/N: JXWBGF-T-2-5800-7100

Frequency Range(MHz)	5800~7100
Insertion Loss(dB)	0.6 max
Isolation(dB)	10 min
VSWR	1.30:1 max
Amplitude Balance(dB)	0.5 max
Phase Balance(°)	5 max
Impedance(Ohms)	50
Power Handling(W)	20 CW (output VSWR<1.5)
Connectors	N-Female
Operating Temperature(°C)	-30~+55
Net Weight(Kg)	0.10 Around

Outline Drawing (Size: mm)

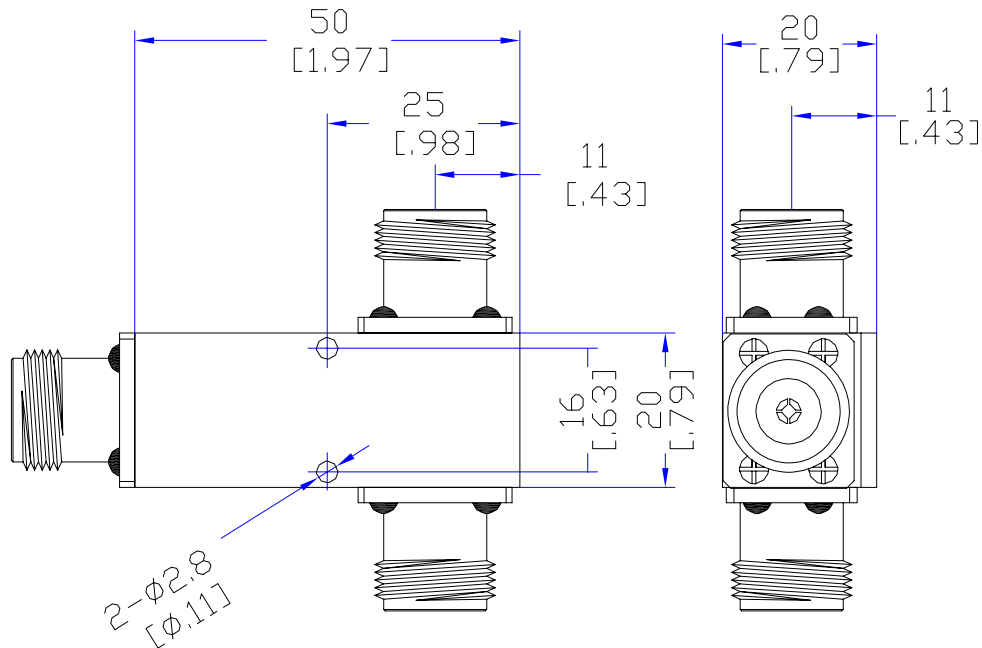

For current data sheets, please contact: sales@aacix.com