

11.0-20.0 GHz GaAs MMIC Packaged Driver Amplifier



March 2006 - Rev 08-Mar-06

CMM1118-QT
RoHS

Features

- ✕ 20 dB Gain
- ✕ 14 dBm P1dB
- ✕ 3x3 QFN Package
- ✕ Single Power Supply
- ✕ 5-7 V, 90 mA Self Bias
- ✕ On-Chip ESD Protection

Circuit Description

Mimix Broadband's 3 stage 11.0 to 20.0 GHz driver amplifier is packaged in surface mount 3x3 QFN package. The device is a self-biased, single supply design with 20 dB gain and 14 dBm P1dB. This MMIC uses Mimix Broadband's 0.25um optical pHEMT process.

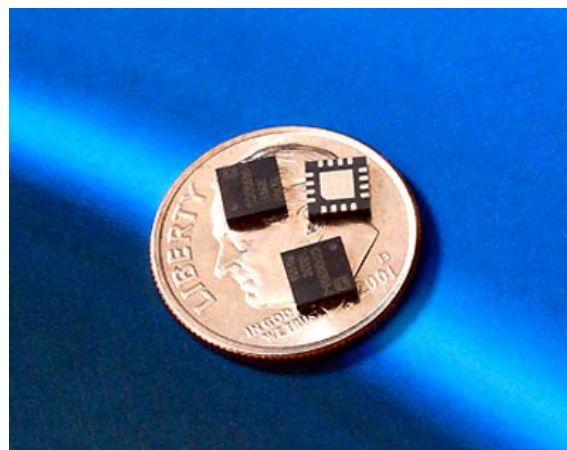

Absolute Maximum Ratings

Supply Voltage	+8 V
RF Input Power	+10 dBm
Storage Temperature (Tstg)	-55 °C to +125 °C
Junction Temperature	175 °C
Operating Temperature	-40 °C to +85°C

Electrical Characteristics (T=25°C)

Parameter	Units	Min.	Typ.	Max.
Frequency Range	GHz	11	-	20
Gain	dB	-	20	-
Input Return Loss		-	-10.5	-
Output P1dB	dBm	-	14	-
Output IP3	dBm	-	22	-
Supply Voltage	V	-	5	-

Typical Parameters

Parameter	Typical				
	12	14	16	18	20
Frequency					
Gain	21.5	20.4	19.6	19.2	20
IP Return Loss	-10.3	-11.2	-10.6	-17	-5.5
Op Return Loss	-8	-18.8	-11	-7.5	-8
P1dB	12.3	12.3	15.5	14.7	16
OIP3	23.3	22.2	23	23	22.2

11.0-20.0 GHz GaAs MMIC Packaged Driver Amplifier



March 2006 - Rev 08-Mar-06

CMM1118-QT
RoHS

Driver Amplifier Measurements

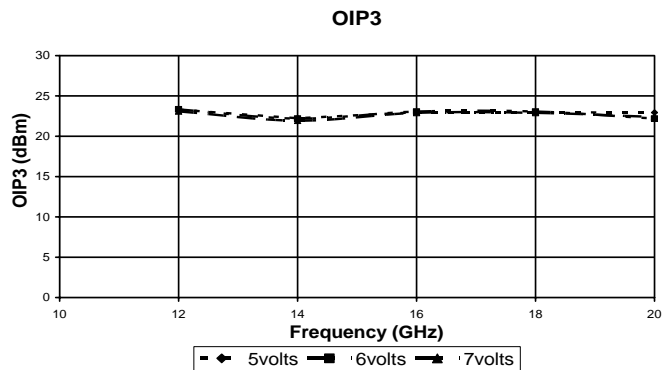
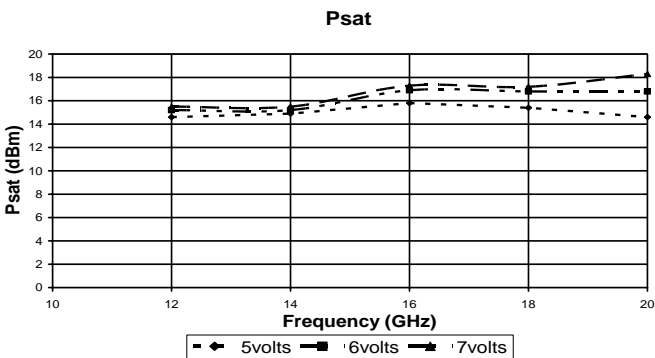
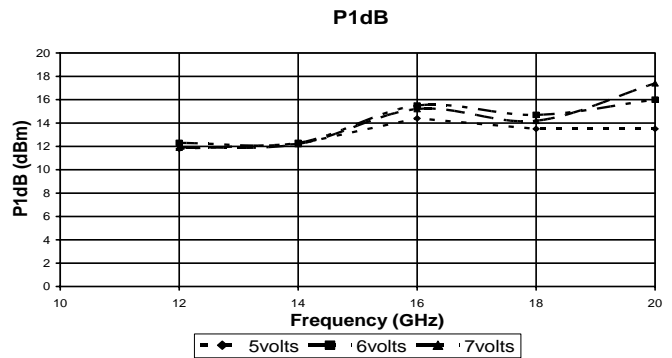
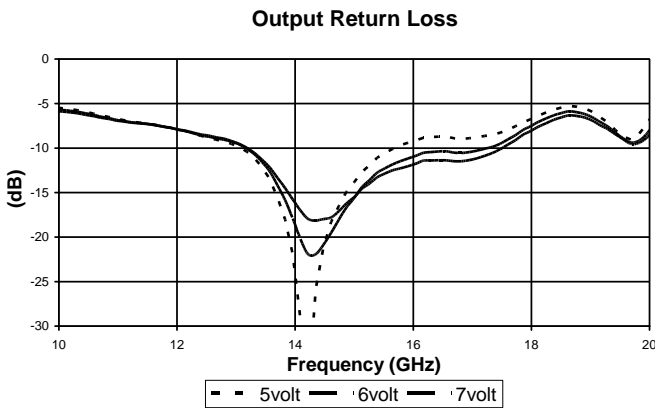
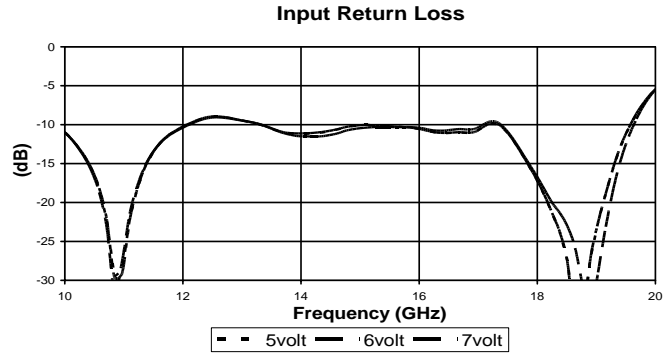
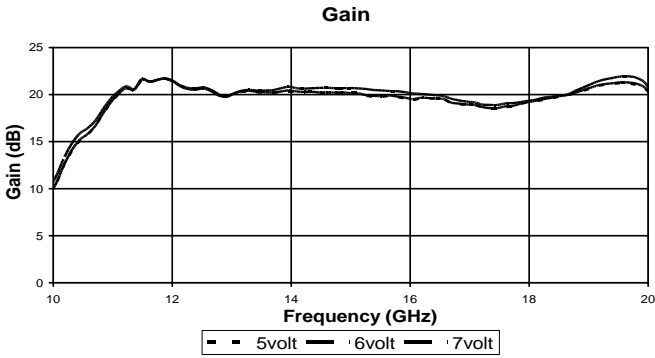

11.0-20.0 GHz GaAs MMIC Packaged Driver Amplifier



March 2006 - Rev 08-Mar-06

CMM1118-QT
RoHS

Driver Amplifier Measurements (cont.)

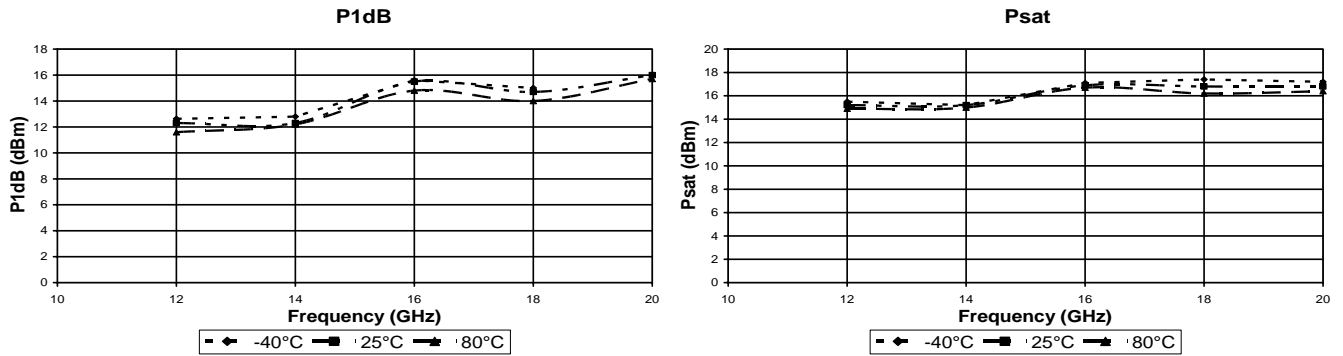

11.0-20.0 GHz GaAs MMIC Packaged Driver Amplifier



March 2006 - Rev 08-Mar-06

CMM1118-QT
RoHS

Evaluation Board Layout

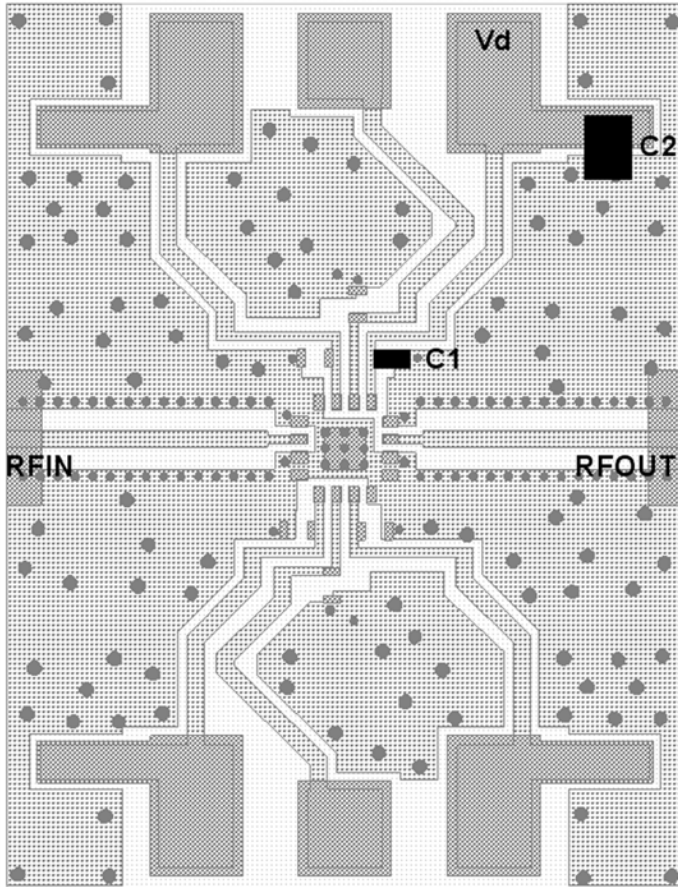

Package Pin-out Table

Pin1	GND or NC
Pin2	RF Input
Pin3	GND or NC
Pin4	GND or NC
Pin5	GND or NC
Pin6	GND or NC
Pin7	GND or NC
Pin8	GND or NC
Pin9	GND or NC
Pin10	GND or NC
Pin11	RF Output
Pin12	GND or NC
Pin13	Vdd
Pin14	GND or NC
Pin15	GND or NC
Pin16	GND

C1 = 1000pF
C2 = 1 F

11.0-20.0 GHz GaAs MMIC Packaged Driver Amplifier



March 2006 - Rev 08-Mar-06

CMM1118-QT
RoHS

Package Outline and Assembly

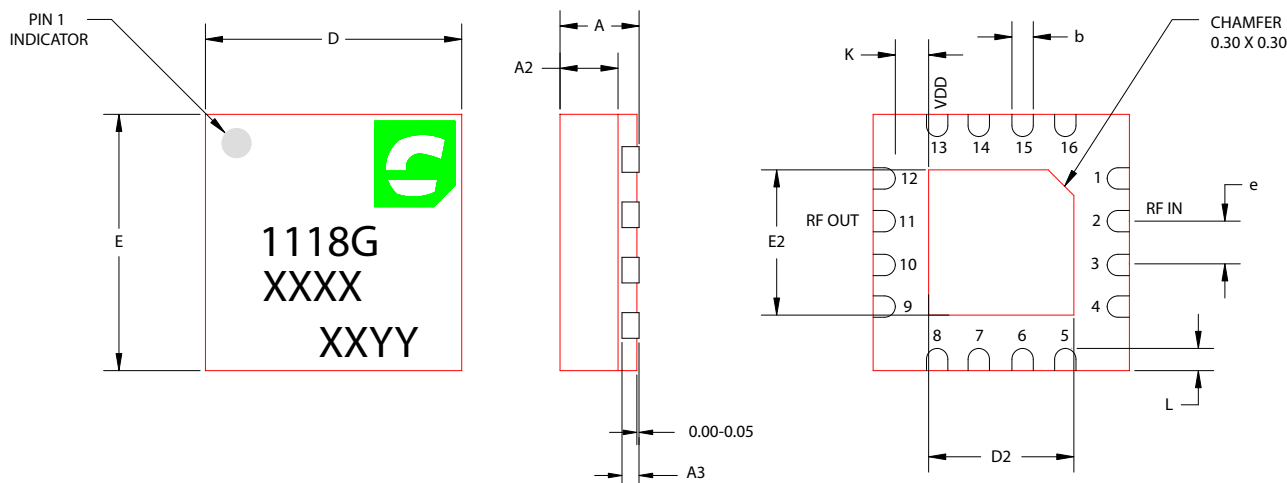

RECOMMENDED SOLDER PAD PITCH AND DIMENSIONS

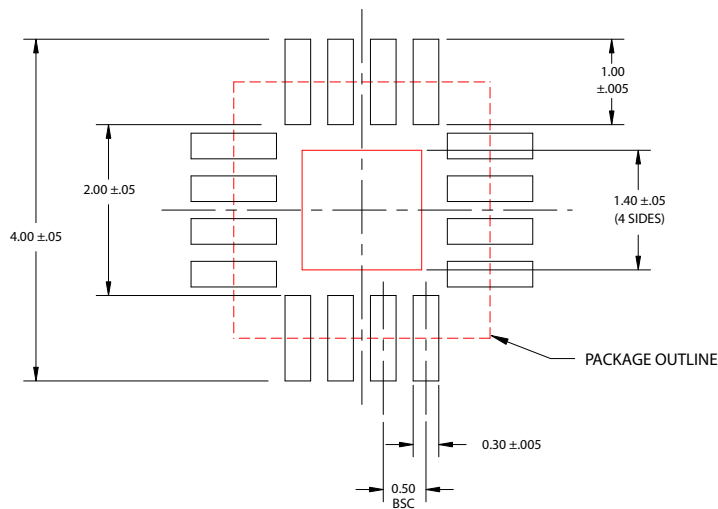

NOTE:

1. ALL DIMENSIONS ARE IN mm

	MIN	NOM	MAX
A	0.80	0.90	1.00
A3	0.20 REF		
A2	0	0.65	1.00
b	0.20	0.25	0.30
K	0.20	-	-
D	3.00 BSC		
E	3.00 BSC		
e	0.50		
D2	1.50	1.65	1.80
E2	1.50	1.65	1.80
L	0.16	0.26	0.36

Ordering Information

Part Number for Ordering

CMM1118-QT-0G00
CMM1118-QT-0G0T
PB-CMM1118-0000

Description

Matte Tin finished RoHS compliant 3x3 QFN in bulk quantity
Matte Tin finished RoHS compliant 3x3 QFN in tape and reel
Evaluation Board

11.0-20.0 GHz GaAs MMIC Packaged Driver Amplifier



March 2006 - Rev 08-Mar-06

CMM1118-QT
XRoHS

Handling and Assembly Information

CAUTION! - Mimix Broadband MMIC Products contain gallium arsenide (GaAs) which can be hazardous to the human body and the environment. For safety, observe the following procedures:

- Do not ingest.
- Do not alter the form of this product into a gas, powder, or liquid through burning, crushing, or chemical processing as these by-products are dangerous to the human body if inhaled, ingested, or swallowed.
- Observe government laws and company regulations when discarding this product. This product must be discarded in accordance with methods specified by applicable hazardous waste procedures.

Life Support Policy - Mimix Broadband's products are not authorized for use as critical components in life support devices or systems without the express written approval of the President and General Counsel of Mimix Broadband. As used herein: (1) Life support devices or systems are devices or systems which, (a) are intended for surgical implant into the body, or (b) support or sustain life, and whose failure to perform when properly used in accordance with instructions for use provided in the labeling, can be reasonably expected to result in a significant injury to the user. (2) A critical component is any component of a life support device or system whose failure to perform can be reasonably expected to cause the failure of the life support device or system, or to affect its safety or effectiveness.

Package Attachment - This packaged product from Mimix Broadband is provided as a rugged surface mount package compatible with high volume solder installation. Care should be taken not to apply heavy pressure to the top or base material to avoid package damage. Vacuum tools or other suitable pick and place equipment may be used to pick and place this part. Care should be taken to ensure that there are no voids or gaps in the solder connection so that good RF, DC and ground connections are maintained. Voids or gaps can eventually lead not only to RF performance degradation, but reduced reliability and life of the product due to thermal stress.

Mimix Lead-Free RoHS Compliant Program - Mimix has an active program in place to meet customer and governmental requirements for eliminating lead (Pb) and other environmentally hazardous materials from our products. All Mimix RoHS compliant components are form, fit and functional replacements for their non-RoHS equivalents. Lead plating of our RoHS compliant parts is 100% matt tin (Sn) over copper alloy and is backwards compatible with current standard SnPb low-temperature reflow processes as well as higher temperature (260°C reflow) "Pb Free" processes.

Part Numbering Designator - For Mimix/Celeritek lead-free products, the letter "G" will be used in the part number for Matte Tin finished RoHS Compliant components and "L" will be used in the part number of NiPdAu finished RoHS Compliant components in the second position of the part number suffix, as shown below:

Example A: CXX1234-XX-0G00 = component bulk quantity Matte Tin finished RoHS compliant parts

Example B: CXX1234-XX-0L0T = component in tape and reel NiPdAu finished RoHS parts

For those customers not making the change at this time, Mimix/Celeritek will maintain production of current configurations. For questions and comments e-mail: ouearth@mimixbroadband.com.