

PLEASE CHECK WWW.MOLEX.COM FOR LATEST PART INFORMATION

Part Number: [0358021229](#)
Status: **Active**
Overview:
Description: 1.00mm (.039") Pitch FFC/FPC Connector, Vertical, Non-ZIF, Yes, 12 Circuits

Agency Certification

CSA LR19980
 UL E29179

General

Product Family FFC/FPC Connectors
 Series 35802
 Comments Use Pre-Notched
 Overview ffc_fpc_throughhole
 Product Name N/A

Physical

Circuits (Loaded) 12
 Circuits (maximum) 12
 Color - Resin Natural
 Contact Position Top
 Durability (mating cycles max) 10
 Entry Angle Vertical
 Flammability 94V-0
 Mated Height (in) 0.205 In
 Mated Height (mm) 5.20 mm
 Material - Metal Phosphor Bronze
 Material - Plating Mating Tin
 Material - Plating Termination Tin
 Material - Resin Nylon
 Number of Rows 1
 Orientation Vertical
 PC Tail Length (in) 0.126 In
 PC Tail Length (mm) 3.20 mm
 PCB Locator No
 PCB Retention Yes
 PCB Thickness Recommended (in) 0.063 In
 PCB Thickness Recommended (mm) 1.60 mm
 Packaging Type Tube
 Pitch - Mating Interface (in) 0.039 In
 Pitch - Mating Interface (mm) 1.00 mm
 Pitch - Term. Interface (in) 0.039 In
 Pitch - Term. Interface (mm) 1.00 mm
 Plating min: Mating (µin) 32.00
 Plating min: Mating (µm) 0.800
 Plating min: Termination (µin) 32.00
 Plating min: Termination (µm) 0.80
 Polarized to PCB No
 Stackable No
 Surface Mount Compatible (SMC) No
 Temperature Range - Operating -20°C to +80°C
 Termination Interface: Style Through Hole - Kinked Pin
 Wire/Cable Type FFC/FPC

Electrical

Current - Maximum per Contact 0.5A
 Voltage - Maximum 50V AC (RMS)/DC

EU RoHS
ELV and RoHS
Compliant
REACH SVHC
 Not Reviewed
Halogen-Free
Status
Not Reviewed

China RoHS



Need more information on product environmental compliance?

Email productcompliance@molex.com
 For a multiple part number RoHS Certificate of Compliance, [click here](#)

Please visit the [Contact Us](#) section for any non-product compliance questions.

Search Parts in this Series
[35802Series](#)

Material Info

Reference - Drawing Numbers

Packaging Specification	PK-35802-001
Product Specification	PS-35802-001
Sales Drawing	SD-35802-**20, SD-35802-010

This document was generated on 06/04/2010

PLEASE CHECK WWW.MOLEX.COM FOR LATEST PART INFORMATION

DO NOT SCALE DRAWING DIMENSION IN METRIC

PROJECT NO. DWG. NO. SD-35802-**-20

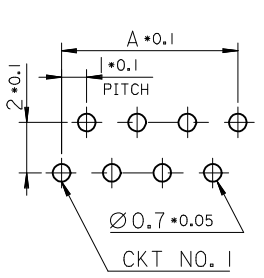
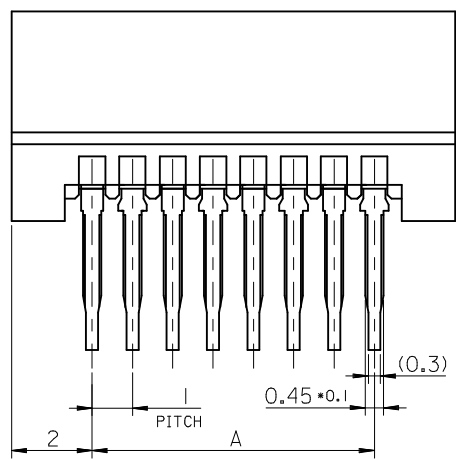
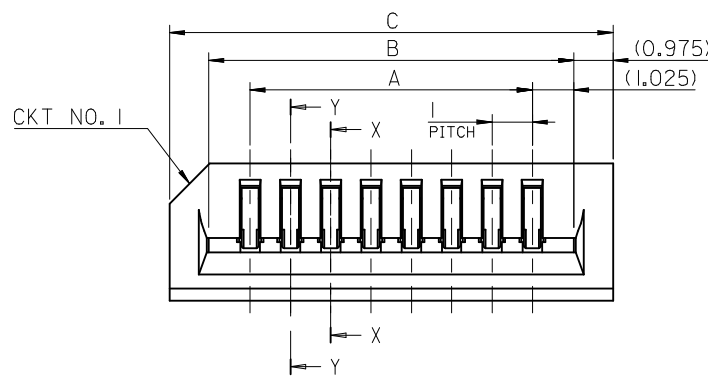

P.C. BOARD LAYOUT (MOUNTING SIDE) (THK.: 1.6±)

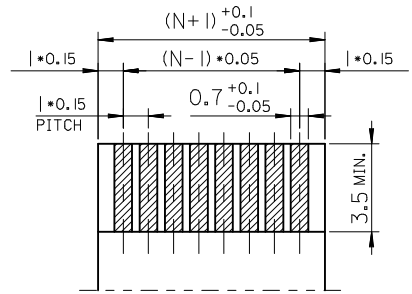

APPLICABLE FPC (THK.: 0.3 ± 0.03)

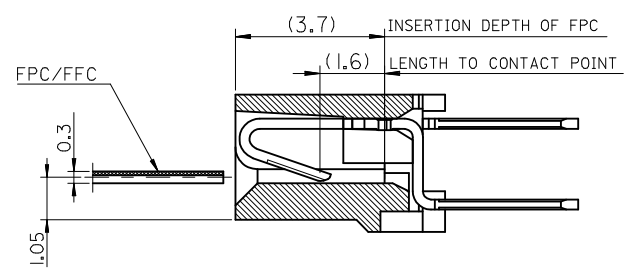

SECTION X-X (ODD CKT)

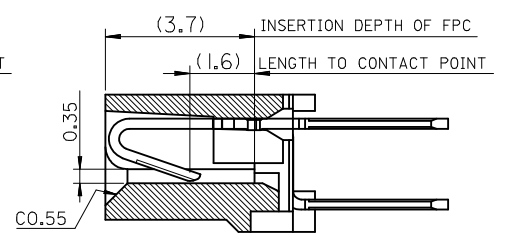

SECTION Y-Y (EVEN CKT)

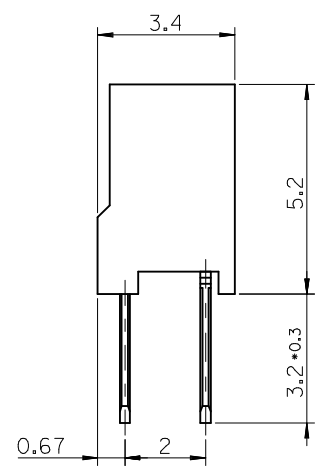

NOTES

- 1. MATERIAL
HOUSING : NYLON66 (UL 94V-0) (COLOR:NATURAL)
TERMINAL : PHOSPHOR BRONZE TIN-PLATED

33	31.05	29	35802-3020	30
32	30.05	28	-2920	29
31	29.05	27	-2820	28
30	28.05	26	-2720	27
29	27.05	25	-2620	26
28	26.05	24	-2520	25
27	25.05	23	-2420	24
26	24.05	22	-2320	23
25	23.05	21	-2220	22
24	22.05	20	-2120	21
23	21.05	19	-2020	20
22	20.05	18	-1920	19
21	19.05	17	-1820	18
20	18.05	16	-1720	17
19	17.05	15	-1620	16
18	16.05	14	-1520	15
17	15.05	13	-1420	14
16	14.05	12	-1320	13
15	13.05	11	-1220	12
14	12.05	10	-1120	11
13	11.05	9	-1020	10
12	10.05	8	-0920	9
11	9.05	7	-0820	8
10	8.05	6	-0720	7
9	7.05	5	-0620	6
8	6.05	4	-0520	5
7	5.05	3	-0420	4
6	4.05	2	35802-0320	3
C	B	A	ENG NO.	CKT NO.

REVISED EC NO. KOR2000-0038 DRWNG: H.S.SHIN 00.5.29 CHK: J.K.OH APPR: C.W.LEE	DESCRIPTION	QUALITY SYMBOLS	GENERAL TOLERANCES: (UNLESS SPECIFIED)		SCALE 8-1	DESIGN UNITS <input checked="" type="checkbox"/> mm <input type="checkbox"/> INCH	THIRD ANGLE PROJECTION	DIMENSIONS: <input type="checkbox"/> mm <input type="checkbox"/> INCH <input checked="" type="checkbox"/> mm ONLY		SHT	REV
		MAJOR =	mm	INCH	DRAWN BY & DATE H.S.SHIN 97.7.31	TITLE: I/O PITCH FFC/FPC CONN. NON-ZIF(DIP) HSG ASS'Y		MOLEX INCORPORATED KOREA	MATERIAL NO. 35-802-**-20	DRAWING NO. SD-35802-**-20	SHEET NO. I/1
CRITICAL =	4 PLACES ±	3 PLACES ±	2 PLACES ±	1 PLACE ±	CHECKED BY & DATE J.K.OH 97.7.31	APPROVED BY & DATE C.W.LEE 97.7.31					
C =	ANGULAR: ± 1°		DRAFT WHERE APPLICABLE MUST REMAIN WITHIN DIMENSIONS		THIS DRAWING CONTAINS INFORMATION THAT IS PROPRIETARY TO MOLEX INCORPORATED AND SHOULD NOT BE USED WITHOUT WRITTEN PERMISSION.		SIZE B				

PROJECT NO. SIMILAR ITEM DWG. NO. SD-35802-010

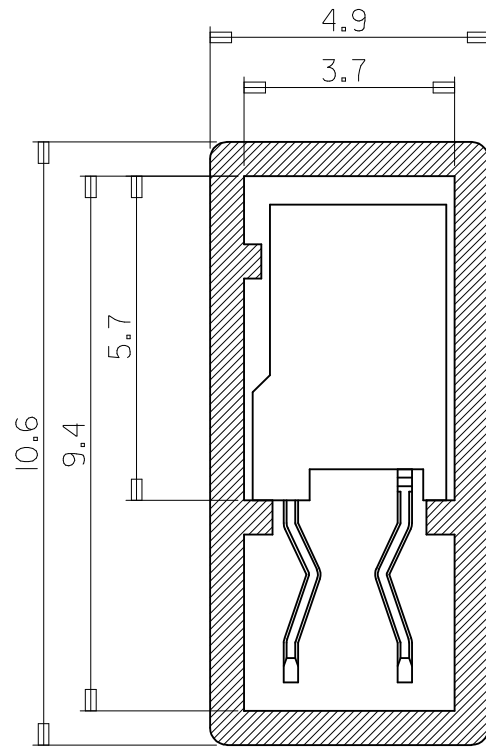

NOTE

1. ENG NO.

HSG ASS'Y	PACKING	SHAPE	
		TAIL	KINK
35802-***10	35802-***19	3.2	0
35802-***20	35802-***29	3.2	X
35802-***30	35802-***89	2.5	0
35802-***40	35802-***49	2.5	X

2. MATERIAL : PVC

3. TUBE LENGTH : 550mm

20	22
21	21
	20
22	19
24	18
25	17
27	16
28	15
30	14
32	13
34	12
37	11
15	30
16	29
	28
17	27
	26
18	25
19	24
	23
Q'TY	CKT
40	10
43	9
47	8
52	7
57	6
65	5
74	4
85	3
Q'TY	CKT

NEW RELEASED EC NO. KOR2002-0037 DRWN: H.S.SHIN 01.10.30 CHK: J.K.OH APPR: C.W.LEE	QUALITY SYMBOLS MAJOR = CRITICAL =	GENERAL TOLERANCES: (UNLESS SPECIFIED)		SCALE 8-1	DESIGN UNITS <input checked="" type="checkbox"/> mm <input type="checkbox"/> INCH	THIRD ANGLE PROJECTION	DIMENSIONS: <input type="checkbox"/> mm <input type="checkbox"/> INCH <input checked="" type="checkbox"/> mm ONLY		SHT	REV	
		4 PLACES	±0.	±.	DRAWN BY & DATE H.S.SHIN 97.7.31		TITLE: TUBE PACKING FOR 35802 SERIES MOLEX INCORPORATED KOREA				
		3 PLACES	±0.	±.	CHECKED BY & DATE J.K.OH 97.7.31						
		2 PLACES	±0.	±.	APPROVED BY & DATE C.W.LEE 97.7.31						
		1 PLACE	±0.3	±.	CAD FILENAME SPK35802.DGN		MATERIAL NO. 35802-***9	DRAWING NO. SD-35802-010	SHEET NO. 1/1		
A	REV	DRAFT WHERE APPLICABLE MUST REMAIN WITHIN DIMENSIONS				THIS DRAWING CONTAINS INFORMATION THAT IS PROPRIETARY TO MOLEX INCORPORATED AND SHOULD NOT BE USED WITHOUT WRITTEN PERMISSION.				SIZE A	