

Technical Data Sheet
OPTO INTERRUPTER ITR

ITR20005

■ **Features**

- Wide gap between lighter and detector (3.8mm)
- High sensing accuracy
- PWB mounting type package
- Pb free
- The product itself will remain within RoHS compliant version.



■ **Descriptions**

The ITR20005(Slot Optical switch) is a gallium arsenide infrared emitting diode which is coupled with a silicon photo transistor in a plastic housing. The package system is designed to optimize the mechanical resolution, coupling efficiency, and insulates ambient light. The ITR is useful in the application of interrupting the signal with printer, scanner, copier, or other opaque material, switching the output from an “ON” to “OFF” state.

■ **Applications**

- Mouse
- Opto-electronic switches
-

■ **Device Selection Guide**

Device No.	Chip Material	Len Color
IR	GaAs,GaAlAs	CLEAR
PT	Silicon	CLEAR

Technical Data Sheet
OPTO INTERRUPTER ITR

ITR20005

Package Dimensions

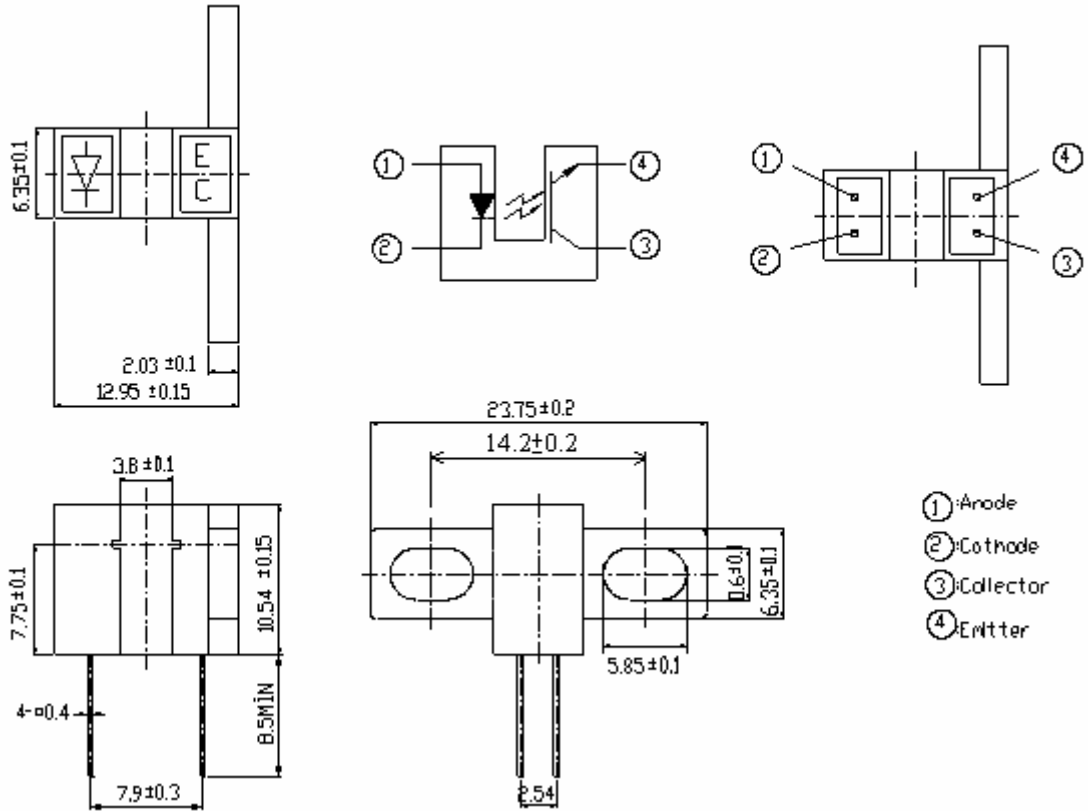

- Notes:**
1. All dimensions are in millimeters
 2. Tolerances unless dimensions ±0.15mm



Technical Data Sheet

OPTO INTERRUPTER ITR

ITR20005

Absolute Maximum Ratings (Ta=25°C)

Parameter		Symbol	Ratings	Unit
Input	Power Dissipation at(or below) 25°C Free Air Temperature	Pd	75	mW
	Reverse Voltage	V _R	5	V
	Forward Current	I _F	50	mA
	Peak Forward Current (*1) Pulse width ≤ 100 μs, Duty cycle=1%	I _{FP}	1	A
	Collector Power Dissipation	P _C	75	mW
Output	Collector Current	I _C	20	mA
	Collector-Emitter Voltage	B V _{CEO}	30	V
	Emitter-Collector Voltage	B V _{ECO}	5	V
	Operating Temperature	Topr	-25~+85	°C
Storage Temperature	Tstg	-40~+85	°C	
Lead Soldering Temperature (*2)	Tsol	260	°C	

(*1) tw=100 μsec., T=10 msec. (*2) t=5 Sec

Electro-Optical Characteristics (Ta=25°C)

Parameter		Symbol	Min.	Typ.	Max.	Unit	Condition
Input	Forward Voltage	V _F	-	1.2	1.6	V	I _F =20mA
	Reverse Current	I _R	-	-	10	μA	V _R =5V
	Peak Wavelength	λ _P	-	940	-	nm	I _F =20mA
	View Angle	2□1/2	-	60	-	Deg	I _F =20mA
Output	Collector Dark Current	I _{CEO}	-	-	100	nA	V _{CE} =10V Ee=0mW/cm ²
Transfer Characteristic	C-E Saturation Voltage	V _{CE(sat)}	-	-	0.4	V	I _C =2mA Ee=1mW/cm ²
	Collector Current	I _{C(ON)}	0.5	-	-	mA	V _{CE} =5V I _F =20mA
	Rise time	t _r	-	20	-	μsec	V _{CE} =5V
	Fall time	t _f	-	20	-	μsec	I _C =1mA R _L =1KΩ

Technical Data Sheet
OPTO INTERRUPTER ITR

ITR20005

Typical Electrical/Optical/Characteristics Curves for IR

Fig. 1 Forward Current vs. Ambient Temperature

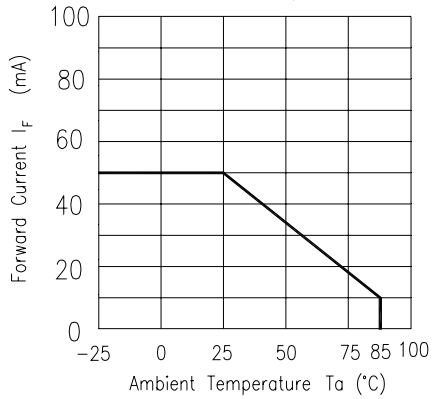

Fig. 2 Spectral Distribution

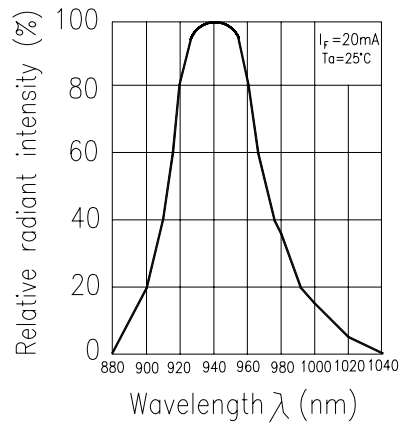

Fig. 3 Peak Emission Wavelength vs. Ambient Temperature

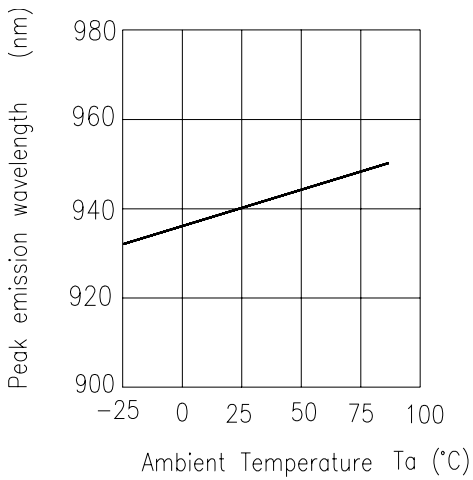

Fig. 4 Forward Current vs. Forward Voltage

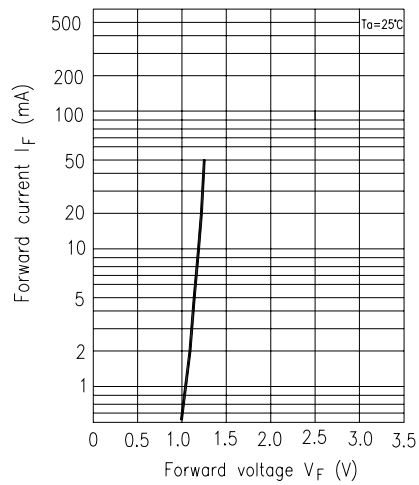

Fig. 5 Forward Voltage vs. Ambient Temperature

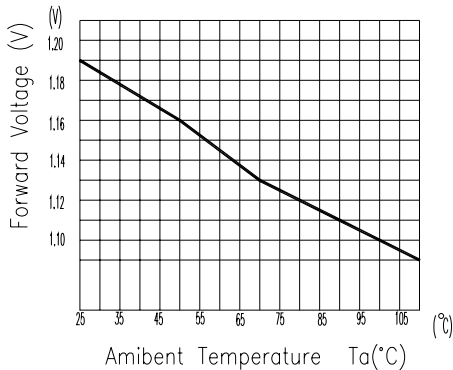
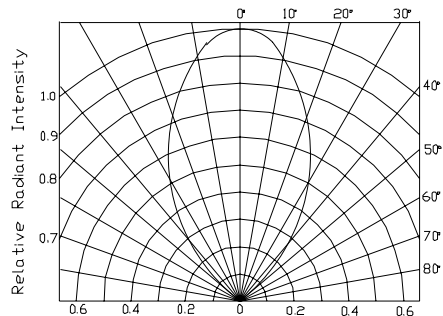

Fig. 6 Relative Radiant Intensity vs. Angular Displacement



Technical Data Sheet
OPTO INTERRUPTER ITR

ITR20005

Typical Electrical/Optical/Characteristics Curves for PT

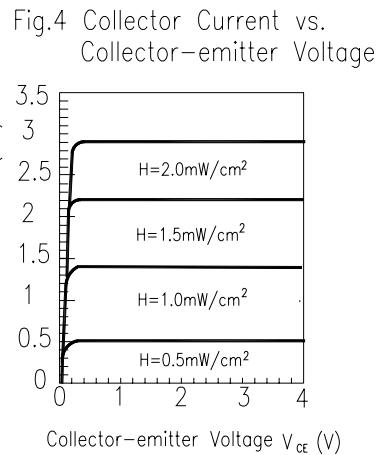
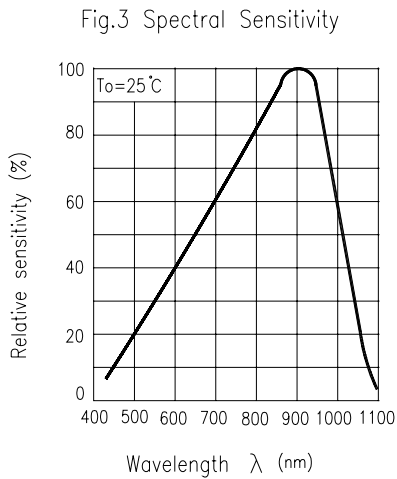
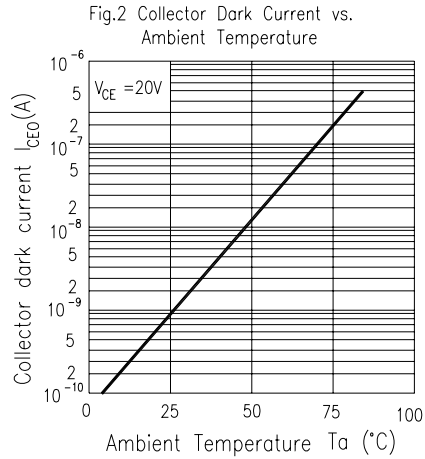
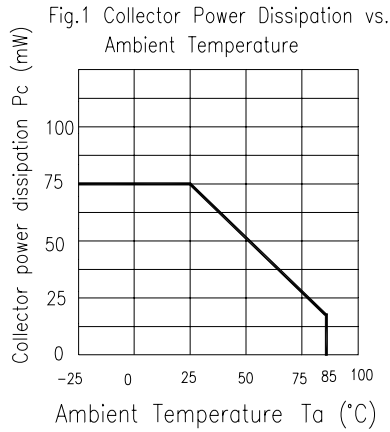

Typical Electrical/Optical/Characteristics Curves For ITR

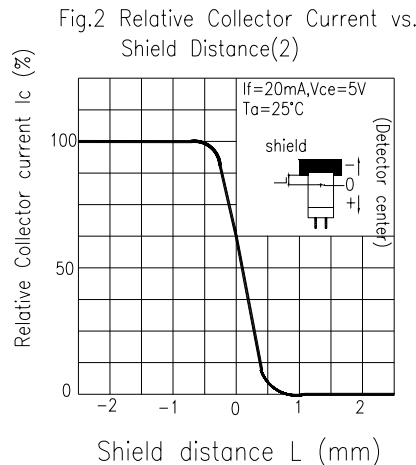
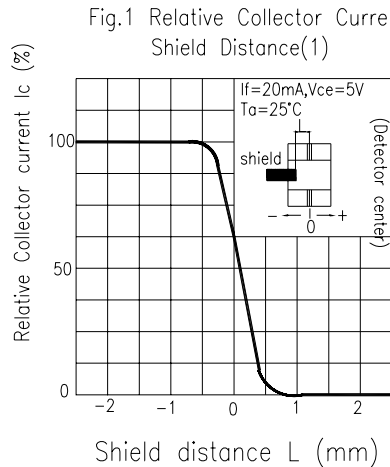



Technical Data Sheet

OPTO INTERRUPTER ITR

ITR20005**Reliability Test Item And Condition**

The reliability of products shall be satisfied with items listed below.

Confidence level : 90%

LTPD : 10%

NO.	Item	Test Conditions	Test Hours/ Cycles	Sample Sizes	Failure Judgement Criteria	Ac/Re
1	Solder Resistance	Ta = 260 ±3°C	10 ± 1 sec	22pcs		0/1
2	Temperature Cycle	H : +85°C 30 mins ↕ 5 mins L : -55°C 30mins	50Cycles	22pcs	I _R ≥ U×2 Ee ≤ L×0.8 V _F ≥ U×1.2	0/1
3	Thermal Shock	H : +100°C 5mins ↕ 10secs L : -10°C 5mins	50Cycles	22pcs	U : Upper Specification	0/1
4	High Temperature Storage	TEMP. : +100°C	1000hrs	22pcs	Limit L : Lower	0/1
5	Low Temperature Storage	TEMP. : -55°C	1000hrs	22pcs	Specification Limit	0/1
6	DC Operating Life	V _{CE} =5V	1000hrs	22pcs		0/1
7	High Temperature/ High Humidity	85°C / 85% R.H	1000hrs	22pcs		0/1

Technical Data Sheet
OPTO INTERRUPTER ITR

ITR20005

Label Form Specification



CPN: Customer's Production Number
P/N : Production Number
QTY: Packing Quantity
CAT: Ranks
HUE: Peak Wavelength
REF: Reference
LOT No: Lot Number
MADE IN TAIWAN: Production Place

Packing Quantity Specification

1. 150 Pcs /1Bag , 4 Bags /1Box
2. 10 Boxes /1Carton

Notes

1. Above specification may be changed without notice. EVERLIGHT will reserve authority on material change for above specification.
2. When using this product, please observe the absolute maximum ratings and the instructions for using outlined in these specification sheets. EVERLIGHT assumes no responsibility for any damage resulting from use of the product which does not comply with the absolute maximum ratings and the instructions included in these specification sheets.
3. These specification sheets include materials protected under copyright of EVERLIGHT corporation. Please don't reproduce or cause anyone to reproduce them without EVERLIGHT's consent.

EVERLIGHT ELECTRONICS CO., LTD. Office: No 25, Lane 76, Sec 3, Chung Yang Rd, Tucheng, Taipei 236, Taiwan, R.O.C	Tel: 886-2-2267-2000, 2267-9936 Fax: 886-2267-6244, 2267-6189, 2267-6306 http://www.everlight.com
---	--