

1. PART NO. EXPRESSION :

SPB1205100YZF-□□
 (a) (b) (c) (d)(e)(f) (g)

- (a) Series code
- (b) Dimension code
- (c) Inductance code : 100 = 10uH
- (d) Tolerance code : M = ±20%, Y = ±30%
- (e) Z : Standard part
- (f) F : RoHS Compliant
- (g) 11 ~ 99 : Internal controlled number

2. CONFIGURATION & DIMENSIONS :

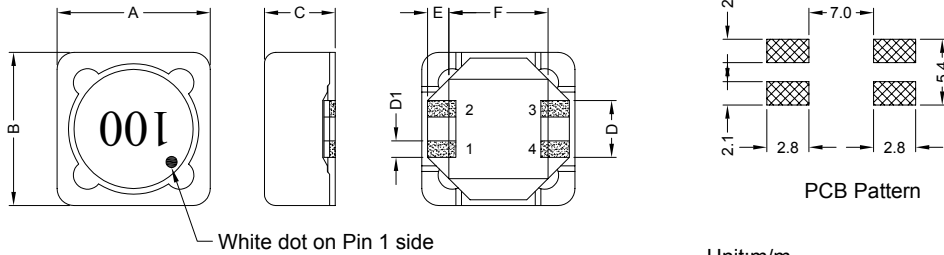

A	B	C	D	D1	E	F
12.5±0.3	12.5±0.3	6.00 Max.	5.00 Ref.	1.70 Ref.	2.20 Ref.	7.6 Ref.

3. SCHEMATIC :

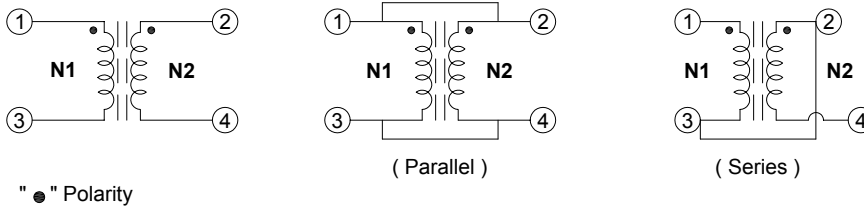

4. MATERIALS :

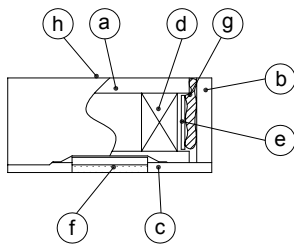

- (a) Core : DR Ferrite Core
- (b) Core : RI Ferrite Core
- (c) Base : LCP-E4008
- (d) Wire : Enamelled Copper Wire
- (e) Tape : #560S
- (f) Terminal : Tinned Copper Plate
- (g) Adhesive : Epoxy Resin
- (h) Ink : Bon Marque



RoHS Compliant

NOTE : Specifications subject to change without notice. Please check our website for latest information.



5. GENERAL SPECIFICATION :

- a) $\Delta L/L0A$: 30% Typ. at Isat
- b) Temp. Rise : 40°C Typ. at Irms
- c) Hi-Pot (N1-N2) : 200Vac / 3mA / 1sec
- d) Operating temp. : -40°C to +125°C
- e) Storage temp. : -40°C to +125°C
- f) Resistance to solder heat : 260°C.10secs

6. ELECTRICAL CHARACTERISTICS :

Part No.	Inductance (μ H) Ref.	Test Frequency (Hz)	Parallel				Series			
			Inductance (μ H) Ref.	RDC (Ω) Max.	Isat (A)	Irms (A)	Inductance (μ H) Ref.	RDC (Ω) Max.	Isat (A)	Irms (A)
SPB1205R56YZF-□□	0.560	0.25V/100K	0.540	0.0043	25.0	9.50	2.100	0.0160	12.50	5.00
SPB12051R0YZF-□□	1.000	0.25V/100K	0.984	0.0050	19.0	8.50	3.576	0.0200	9.20	4.60
SPB12051R5YZF-□□	1.500	0.25V/100K	1.478	0.0060	12.5	8.20	5.912	0.0245	7.00	4.00
SPB12052R2YZF-□□	2.200	0.25V/100K	2.208	0.0075	12.0	8.00	8.832	0.0290	6.00	3.80
SPB12053R3YZF-□□	3.300	0.25V/100K	3.084	0.0095	10.2	4.80	12.340	0.0380	5.00	3.20
SPB12054R5YZF-□□	4.500	0.25V/100K	4.250	0.0105	9.00	4.60	16.510	0.0410	4.50	2.80
SPB12056R8YZF-□□	6.800	0.25V/100K	6.588	0.0165	7.00	4.30	26.350	0.0640	3.50	2.30
SPB12058R2YZF-□□	8.200	0.25V/100K	8.048	0.0180	6.50	4.00	32.190	0.0700	3.10	2.00
SPB1205100YZF-□□	10.000	0.25V/100K	9.654	0.0224	5.70	3.70	38.620	0.0895	2.80	1.80
SPB1205150YZF-□□	15.000	0.25V/100K	15.350	0.0298	4.70	3.30	61.400	0.1190	2.30	1.65
SPB1205220YZF-□□	22.000	0.25V/100K	22.360	0.0420	3.65	3.00	89.440	0.1720	1.80	1.52
SPB1205330YZF-□□	33.000	0.25V/100K	33.740	0.0600	3.10	2.70	135.000	0.2460	1.55	1.30
SPB1205470YZF-□□	47.000	0.25V/100K	47.470	0.0810	2.60	2.20	189.900	0.3250	1.35	1.10
SPB1205680YZF-□□	68.000	0.25V/100K	67.910	0.1180	2.20	1.80	271.000	0.4600	1.10	0.80
SPB1205820YZF-□□	82.000	0.25V/100K	86.890	0.1400	2.00	1.60	347.600	0.5580	1.00	0.75
SPB1205101MZF-□□	100.000	0.25V/100K	102.700	0.1830	1.75	1.40	410.800	0.7280	0.90	0.50
SPB1205151MZF-□□	150.000	0.25V/100K	151.100	0.2640	1.50	1.10	604.400	1.0500	0.75	0.45
SPB1205221MZF-□□	220.000	0.25V/100K	216.800	0.3760	1.20	0.90	867.200	1.4900	0.60	0.38
SPB1205331MZF-□□	330.000	0.25V/100K	332.600	0.5600	1.00	0.70	1330.000	2.2400	0.48	0.35
SPB1205471MZF-□□	470.000	0.25V/100K	473.100	0.7740	0.82	0.55	1892.000	3.1000	0.38	0.30
SPB1205681MZF-□□	680.000	0.25V/100K	679.800	1.1450	0.71	0.45	2719.000	4.5800	0.33	0.27
SPB1205821MZF-□□	820.000	0.25V/100K	828.000	1.4590	0.63	0.38	3312.000	5.8400	0.31	0.20
SPB1205102MZF-□□	1000.00	0.25V/100K	975.200	1.6600	0.60	0.28	4032.000	6.6600	0.29	0.18

Tolerance code : M = $\pm 20\%$

Y = $\pm 30\%$



RoHS Compliant

NOTE : Specifications subject to change without notice. Please check our website for latest information.

17.12.2010



SUPERWORLD ELECTRONICS (S) PTE LTD

7. CHARACTERISTICS CURVES : (PARALLEL)

@ TEMP. RISE VS. DC SUPERPOSITION RESPONSE CURVE

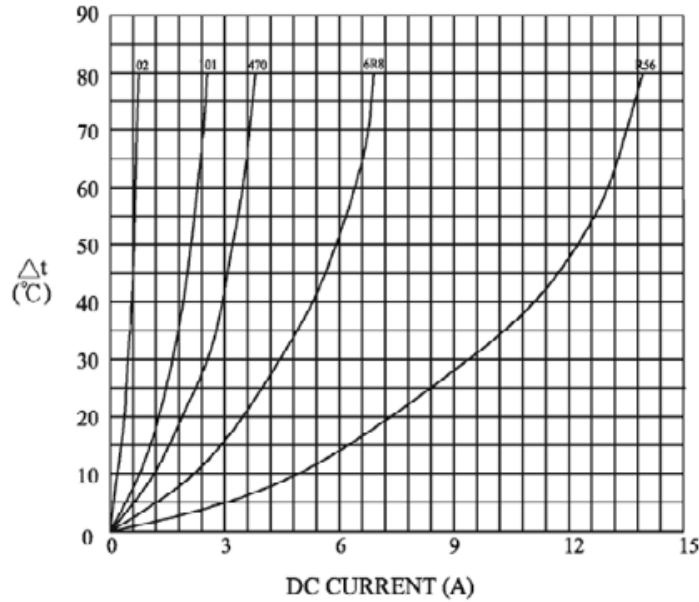

@ INDUCTANCE VS. FREQUENCY RESPONSE CURVE

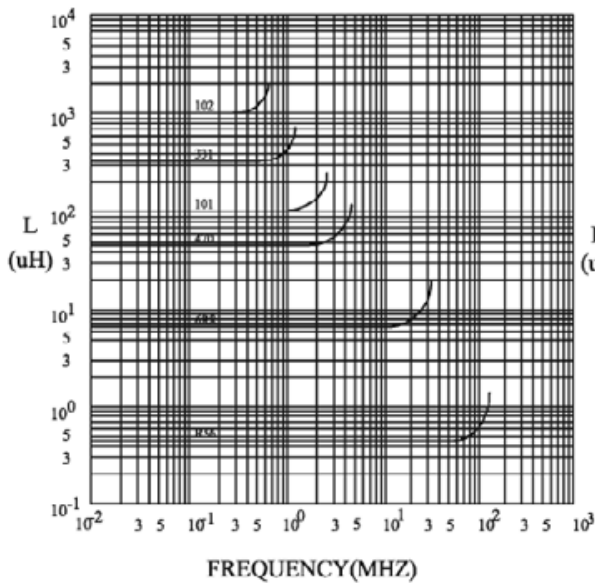

@ INDUCTANCE VS. DC SUPERPOSITION RESPONSE CURVE

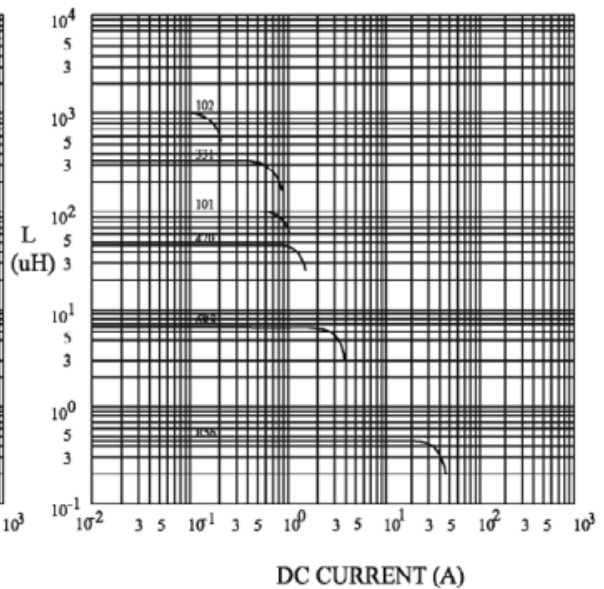

RoHS Compliant

NOTE : Specifications subject to change without notice. Please check our website for latest information.

17.12.2010



SUPERWORLD ELECTRONICS (S) PTE LTD

7. CHARACTERISTICS CURVES : (SERIES)

@ TEMP. RISE VS. DC SUPERPOSITION RESPONSE CURVE

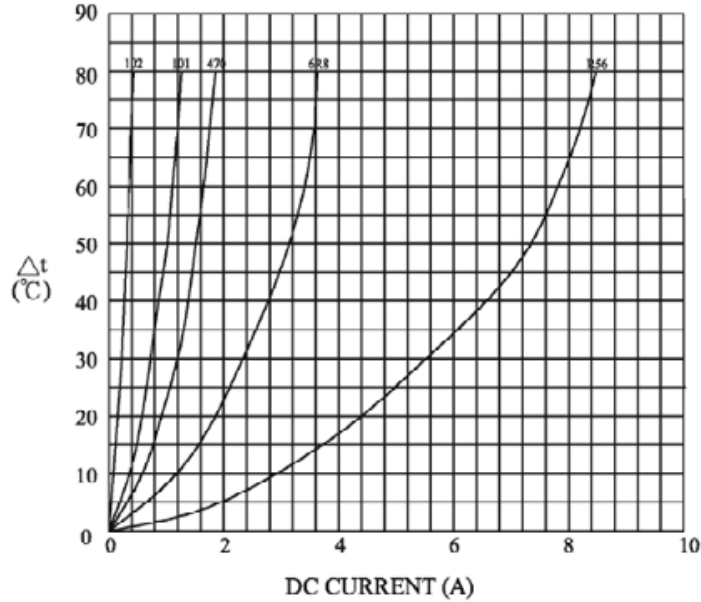

@ INDUCTANCE VS. FREQUENCY RESPONSE CURVE

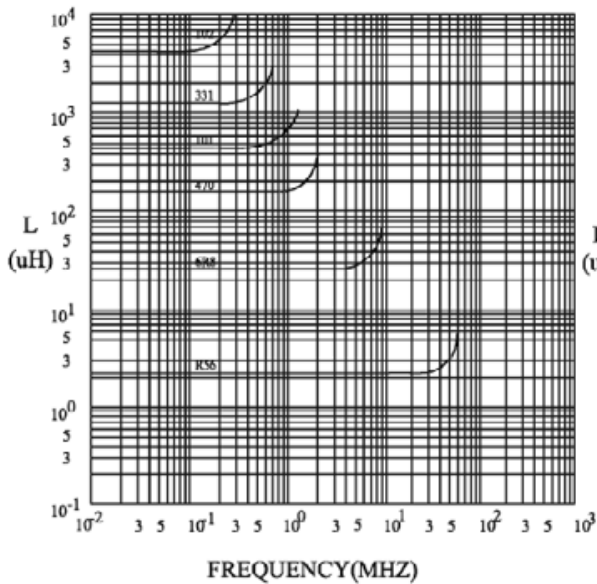

@ INDUCTANCE VS. DC SUPERPOSITION RESPONSE CURVE

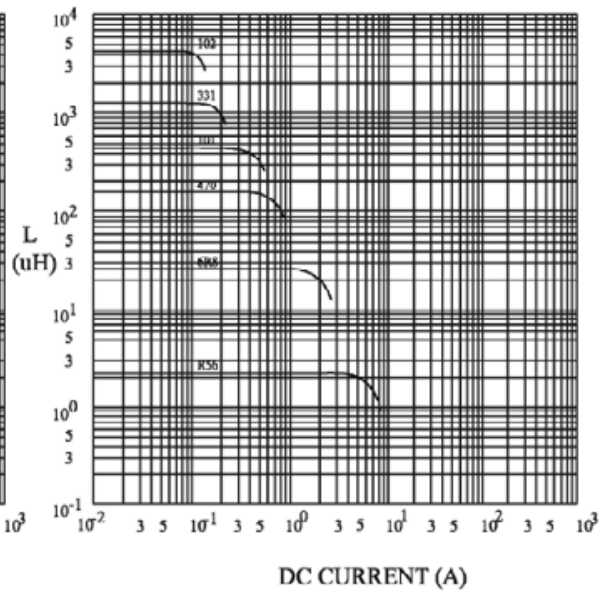

RoHS Compliant

NOTE : Specifications subject to change without notice. Please check our website for latest information.

17.12.2010



SUPERWORLD ELECTRONICS (S) PTE LTD

RECOMMENDED SOLDERING CONDITIONS REFLOW SOLDERINGS

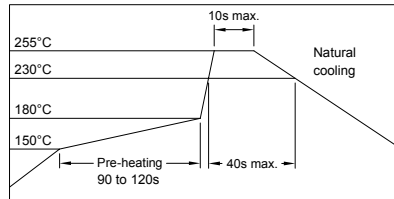

8. PACKAGING INFORMATION :

(1) CONFIGURATION

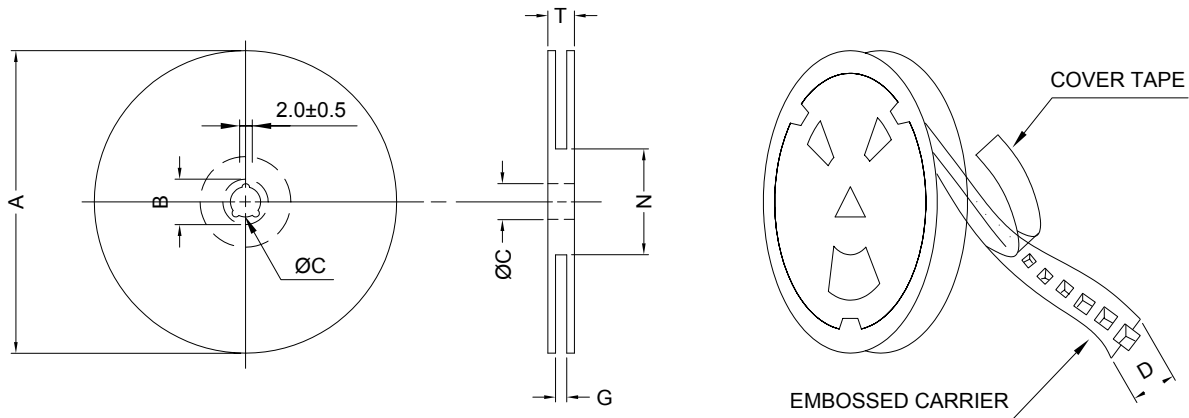

* CARRIER TAPE WIDTH : D

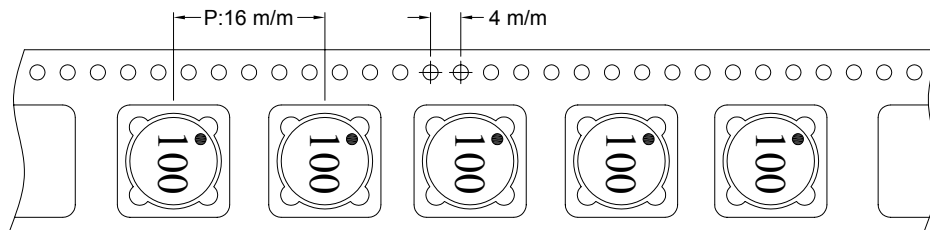

(2) DIMENSIONS

Unit:m/m

STYLE	A	B	C	D	G	N	T
13-24	330	21±0.8	13±0.5	24	26 ⁺⁰	50 ⁻⁰	30.4

(3) Q'TY & G.W. PER PACKAGE

SERIES	INNER : REEL			OUTER : CARTON		
	Q'TY (PCS)	G.W. (gw)	STYLE	Q'TY (PCS)	G.W. (Kg)	SIZE (cm)
SPB1205	600	1900	13-24	2400	11.1	38 x 36.5 x 21



RoHS Compliant

NOTE : Specifications subject to change without notice. Please check our website for latest information.

17.12.2010



SUPERWORLD ELECTRONICS (S) PTE LTD

9. RELIABILITY AND TEST CONDITION :

TEST ITEM	SPECIFICATION	TEST CONDITION
SOLDERABILITY	MORE THAN 90% OF THE TERMINAL ELECTRODE SHALL BE COVERED WITH FRESH SOLDER.	PREHEAT : 125±25°C FOR 60 SECONDS SOLDER : 99%Sn/0.3%Ag/0.7%Cu OR EQUIVALENT SOLDER TEMP. : 245±5°C FLUX : ROSIN DIP TIME : 4±1 SECONDS
THERMAL SHOCK TEST (TEMP. CYCLE)	INDUCTANCE SHALL NOT CHANGE MORE THAN ±20%	ROOM TEMP. → -25±2°C 15 MINUTES → 30 MINUTES ROOM TEMP. → 85±2°C 15 MINUTES → 30 MINUTES TOTAL : 50 CYCLES
HUMIDITY RESISTANCE TEST		TEMPERATURE : 40±2°C HUMIDITY : 90 ~ 95% APPLIED CURRENT : PER SPEC. TIME : 500 HOURS
HIGH TEMP. RESISTANCE TEST		TEMPERATURE : 85±2°C APPLIED CURRENT : PER SPEC. TIME : 500 HOURS

10. UL CARD :

OBMW2		November 30, 2000	
Magnet Wire - Component			
PACIFIC ELECTRIC WIRE & CABLE (SHENZHEN) CO LTD			E201757
607 BAOLONG INDUSTRIAL ESTATE LONGGANG, SHENZHEN GUANGDONG CHINA			
	Coating Type	ANSI Type	TI
Mtl Dsg	BC	TC	—
UEW/U	Polyurethane	—	130
PEW/U	Polyester	—	155°C
PEWH/U	Modified Polyester	—	MW5-C 180
PEW-NY/U	Polyester	Polyamide	MW30-C 155
HAI/U	Polyester(Amide)(Imide)	Polyamideimide	MW24-C 200
UEW-NY/U	Polyurethane	Polyamide	MW35,73 155
			MW80-C 130
			MW28-C 130
<p>Marking: Company name and material designation or marked designation on package or reel, and Recognized Component Mark.</p> <p>See General Information Preceding These Recognitions</p>			
1/3/2001	Underwriters Laboratories Inc.	Card 1 of 2	



RoHS Compliant

NOTE : Specifications subject to change without notice. Please check our website for latest information.



SUPERWORLD ELECTRONICS (S) PTE LTD

17.12.2010

10. UL CARD :

SUMITOMO CHEMICAL CO LTD										E54705 (M)			
5-33 KITAHAMA 4-CHOME CHUO-KO, OSAKA JAPAN													
Mtl Dsg	Col	Min Thk mm	UL94 Flame Class	Elec	RTI		H W I	H A I	H V T R	D 4 5	C 9 T I		
					with Imp	Mech w/o Imp							
Liquid crystal polyester (LCP), designated "EKONOL" or "SUMIKASUPER", furnished in the form of pellets, (Contd)													
E4008 , E400X	NC , BK	0.30	94V-0	130	130	130	—	—	—	—	—		
		0.75	94V-0	130	130	130	3	4	—	—	—		
		1.5	94V-0	130	130	130	2	4	—	—	—		
		3.0	94V-0	130	130	130	1	4	0	5	4		
E4008	NC , WT , BK	0.30	94V-0	130	130	130	—	—	—	—	—		
		0.75	94V-0	220	180	220	3	4	—	—	—		
		1.5	94V-0	220	200	240	2	4	—	—	—		
		3.0	94V-0	220	200	240	1	4	0	5	4		
E4010	NC , BK	0.30	94V-0	130	130	130	—	—	—	—	—		
		0.75	94V-0	220	180	220	3	4	—	—	—		
		1.5	94V-0	220	200	240	2	4	—	—	—		
		3.0	94V-0	220	200	240	1	4	0	5	4		
E400(Y)L , E4008L	NC , BK	0.30	94V-0	130	130	130	—	—	—	—	—		
		0.75	94V-0	130	130	130	3	4	—	—	—		
		1.5	94V-0	130	130	130	2	4	—	—	—		
		3.0	94V-0	130	130	130	1	4	0	5	4		
E4810	NC , BK	0.30	94V-0	130	130	130	—	—	—	—	—		
		0.75	94V-0	130	130	130	0	4	—	—	—		
		1.5	94V-0	130	130	130	0	4	—	—	—		
		3.0	94V-0	130	130	130	1	4	0	5	4		

(X) Denotes any number 1 thru 9.
(Y) Denotes any number 1 thru 7.

TERAOKA SEISAKUSHO CO LTD										E56086 (S)			
4-22 1-CHOME HIROMACHI SHINAGAWA-KU, TOKYO JAPAN													
Flame retardant aramid paper tape, Cat. Nos. 512F+, 560F+, 565S+, 681S+.													
Flame retardant aramid paper tape, Cat. Nos. 560S+, 561S+, 562S+, rated 200 C.													
Flame retardant acetate cloth tape, Cat. Nos. 570F+, 571F+, 573F+.													
Flame retardant polyester film tape, Cat. Nos. 680F+, 684F+.													
Flame retardant glass cloth tape, Cat. Nos. 510F+, 540S+, 541F+, 685S+.													
Flame retardant glass cloth tape, Cat. No. 54S, rated 200 C.													
Flame retardant cotton cloth tape, Cat. Nos. 590F+, 715F+.													
Flame retardant polyimide film tape, Cat. No. 650S+, rated 200 C.													
Flame retardant tellon tape, Cat. Nos. 841+, 846+.													
Flame retardant PVC tape, Cat. Nos. 305F+, 307F+, 380F+.													
Flame retardant polyester fiber tape, Cat. Nos. 511F+, 551F+.													
Flame retardant epoxy varnish impregnated polyester web tape, Cat. Nos. 530F+.													
Flame retardant epoxy varnish impregnated glass paper tape, Cat. No. 531F+.													
Flame retardant copper foil tape, Cat. No. 831S+.													
Flame retardant copper foil tape, Cat. No. 8321+.													
Flame retardant aluminum foil tape, Cat. Nos. 833+, 834+.													
Epoxy varnish impregnated polyester non-woven fabric tape, cat. no. 530F° rated 150 C.													
polyester film tape, Cat. Nos. 631S°, 632S, rated 130 C.													
Flame retardant polyester film tape, Cat. No. 630F°, rated 130 C.													
Flame retardant polyester film/epoxy varnish impregnated polyester fiber tape Cat. No. 673F°, rated 130 C.													
Flame retardant polyester film/epoxy varnish impregnated polyester fiber/polyester film tape, Cat. No. 850F°, rated 130 C.													
+ - Subjected to Flame Retardant tests only.													
° - Complies with Flame Retardent requirements when so marked.													
Mraking: Company name or "E56086" and catalog designation and "Flame Retardent" if applyce, bic. printed on the central paper or outer package.													



RoHS Compliant

NOTE : Specifications subject to change without notice. Please check our website for latest information.



SUPERWORLD ELECTRONICS (S) PTE LTD

17.12.2010

PG. 7