

RoHS **Sxx04xSx Series**

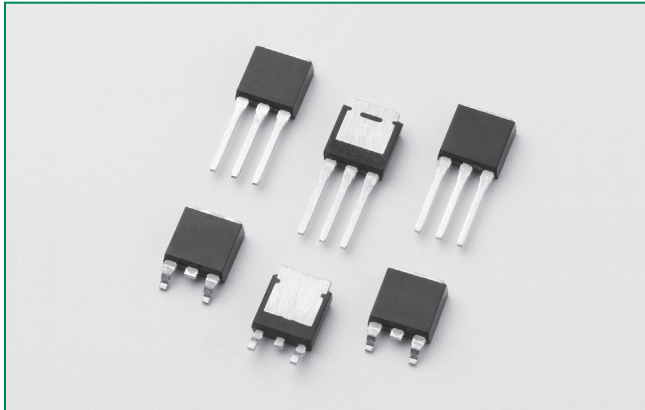

Description

Excellent unidirectional switches for phase control applications such as heating and motor speed controls. Sensitive gate SCRs are easily triggered with microAmps of current as furnished by sense coils, proximity switches, and microprocessors.

Features & Benefits

- RoHS compliant
- Glass – passivated junctions
- Voltage capability up to 600 V
- Surge capability up to 30 A

Main Features

Symbol	Value	Unit
$I_{T(RMS)}$	4	A
V_{DRM}/V_{RRM}	400 to 600	V
I_{GT}	50 to 500	μA

Applications

Typical applications are capacitive discharge systems for strobe lights, nailers, staplers and gas engine ignition. Also controls for power tools, home/brown goods and white goods appliances.

Schematic Symbol

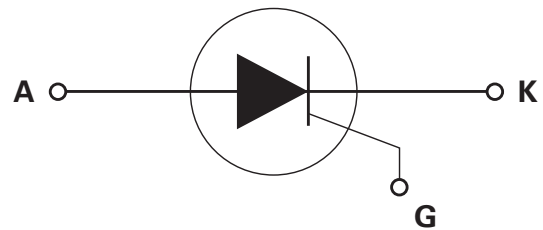

Absolute Maximum Ratings

Symbol	Parameter	Test Conditions	Value	Unit
$I_{T(RMS)}$	RMS on-state current	$T_c = 95^\circ C$	4	A
$I_{T(AV)}$	Average on-state current	$T_c = 75^\circ C$	2.5	A
I_{TSM}	Peak non-repetitive surge current	single half cycle; $f = 50Hz$; T_j (initial) = $25^\circ C$	25	A
		single half cycle; $f = 60Hz$; T_j (initial) = $25^\circ C$	30	
I^2t	I^2t Value for fusing	$t_p = 8.3$ ms	3.7	A^2s
di/dt	Critical rate of rise of on-state current	$f = 60Hz$; $T_j = 110^\circ C$	50	$A/\mu s$
I_{GM}	Peak gate current	$T_j = 110^\circ C$	1	A
$P_{G(AV)}$	Average gate power dissipation	$T_j = 110^\circ C$	0.1	W
T_{stg}	Storage temperature range		-40 to 150	$^\circ C$
T_j	Operating junction temperature range		-40 to 110	$^\circ C$

4.0A SCRs

Electrical Characteristics — ($T_J = 25^\circ\text{C}$, unless otherwise specified)

Symbol	Test Conditions		Value		Unit
			Sxx04xS1	Sxx04xS2	
I_{GT}	$V_D = 6\text{V}; R_L = 100\ \Omega$	MAX.	50	200	μA
V_{GT}		MAX.	0.8		V
dv/dt	$V_D = V_{DRM}; R_{GK} = 1\text{k}\Omega$	TYP.	8		V/ μs
V_{GD}	$V_D = V_{DRM}; R_L = 3.3\ \text{k}\Omega; T_J = 110^\circ\text{C}$	MIN.	0.2		V
V_{GRM}	$I_{GR} = 10\ \mu\text{A}$	MIN.	6		V
I_H	$I_T = 20\text{mA}$ (initial); $R_{GK} = 1\text{kohm}$	MAX.	4	6	mA
t_q	(1)	MAX.	50		μs
t_{gt}	$I_G = 2 \times I_{GT}; \text{PW} = 15\ \mu\text{s}; I_T = 8\text{A}$	TYP.	3	4	μs

Notes :
xx = voltage, x = package
(1) $I_T=2\text{A}; t_p=50\ \mu\text{s}; dv/dt=5\text{V}/\mu\text{s}; di/dt=10\text{A}/\mu\text{s}$

Static Characteristics

Symbol	Test Conditions		Value	Unit
V_{TM}	Sxx04xSy $I_T = 8\text{A}; t_p = 380\ \mu\text{s}$	MAX.	1.6	V
I_{DRM} / I_{RRM}	$V_{DRM} / V_{RRM} - R_{GK} = 1\text{kohm}$	$T_J = 25^\circ\text{C}$	2	μA
		$T_J = 110^\circ\text{C}$	100	

Note : xx or z = voltage, x = package, y = sensitivity

Thermal Resistances

Symbol	Parameter		Value	Unit
$R_{\theta(J-C)}$	Junction to case (AC)	Sxx04Vsy	3.8	$^\circ\text{C}/\text{W}$
		Sxx04DSy	3.0	
$R_{\theta(J-A)}$	Junction to ambient	Sxx04Vsy	85	$^\circ\text{C}/\text{W}$

Notes: xx = voltage, y = sensitivity

Figure 1: Normalized DC Gate Trigger Current vs. Junction Temperature

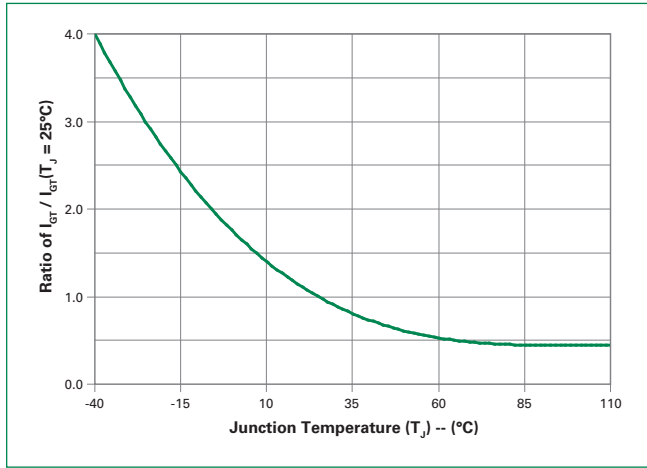

Figure 2: Normalized DC Gate Trigger Voltage vs. Junction Temperature

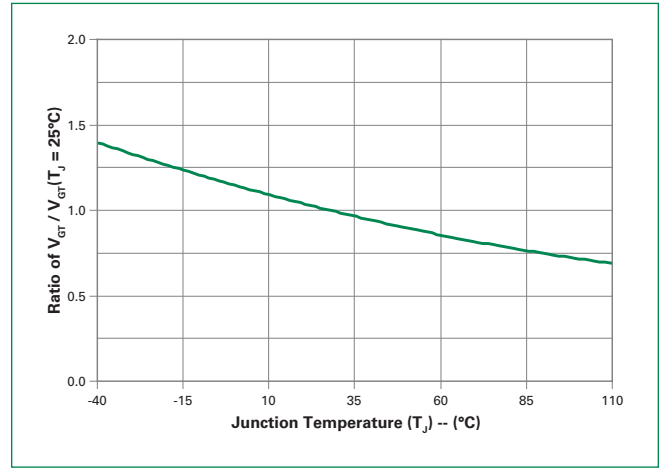

Figure 3: Normalized DC Holding Current vs. Junction Temperature

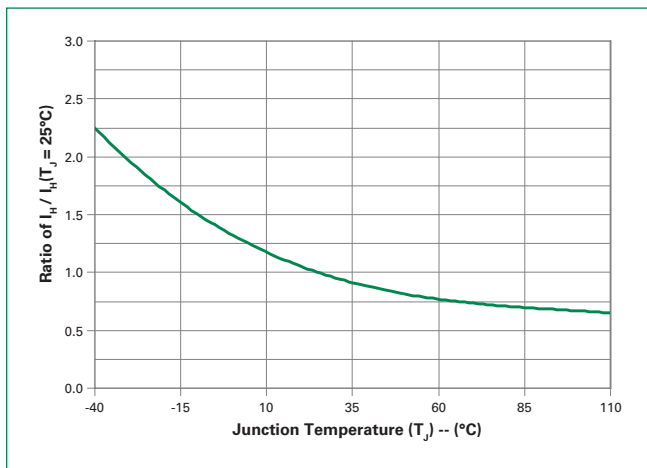

Figure 4: Normalized DC Latching Current vs. Junction Temperature

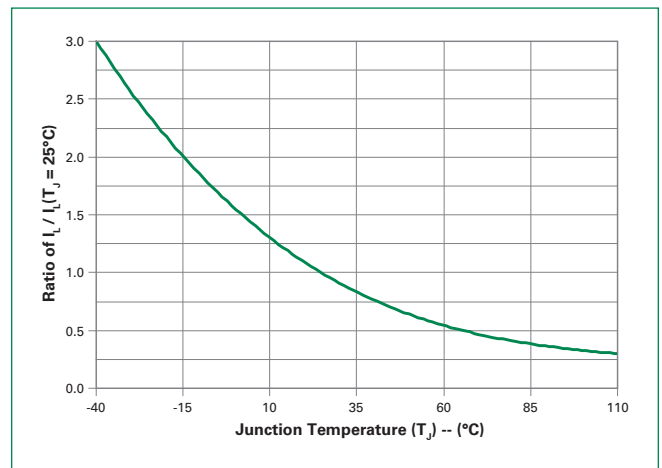

Figure 5: On-State Current vs. On-State Voltage (Typical)

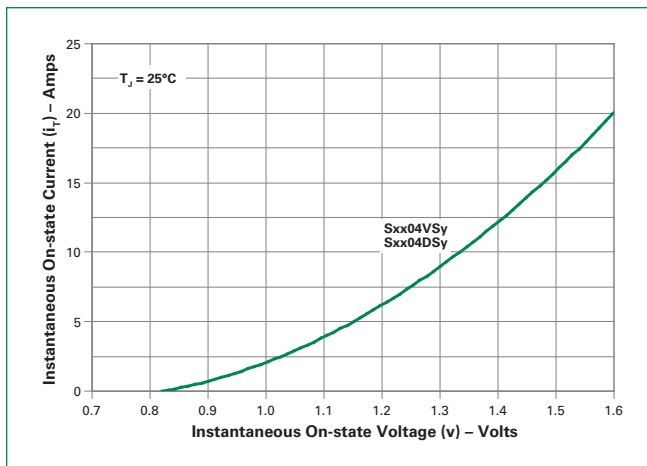
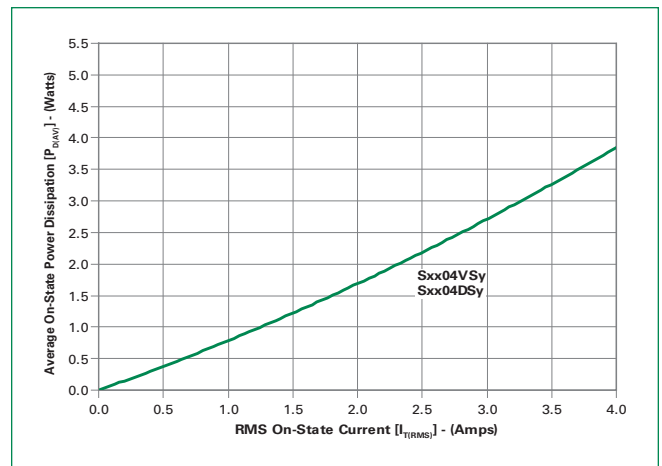

Figure 6: Power Dissipation (Typical) vs. RMS On-State Current



Note: xx or z = voltage, y = sensitivity

Figure 7: Maximum Allowable Case Temperature vs. RMS On-State Current

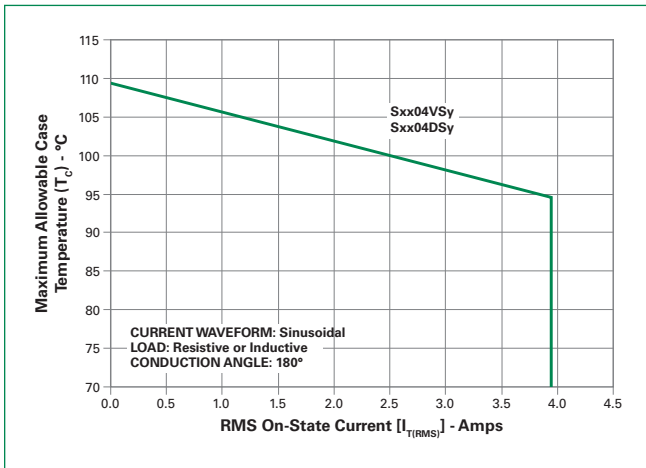

Figure 8: Maximum Allowable Case Temperature vs. Average On-State Current

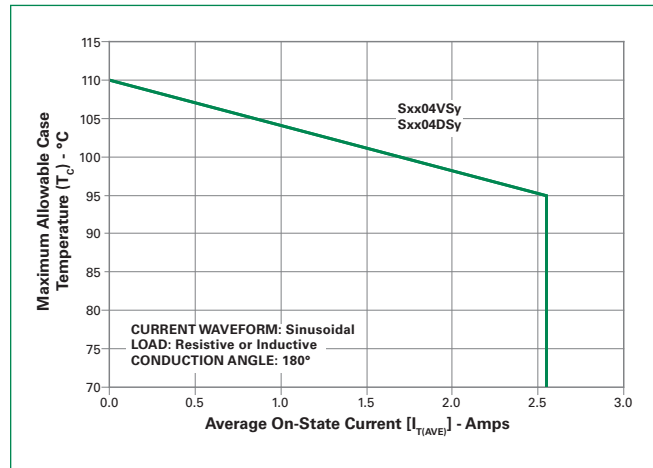

Figure 9: Maximum Allowable Ambient Temperature vs. RMS On-State Current

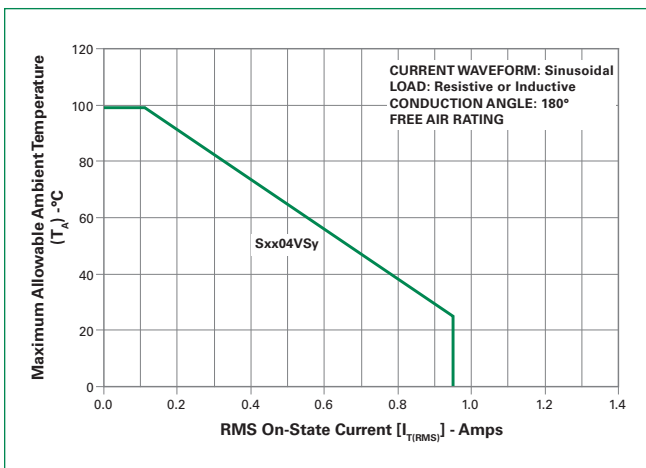

Figure 10: Maximum Allowable Ambient Temperature vs. Average On-State Current

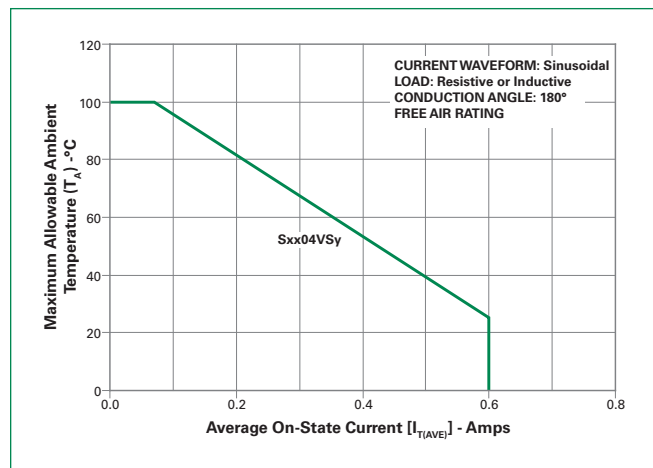

Figure 11: Peak Repetitive Capacitor Discharge Current

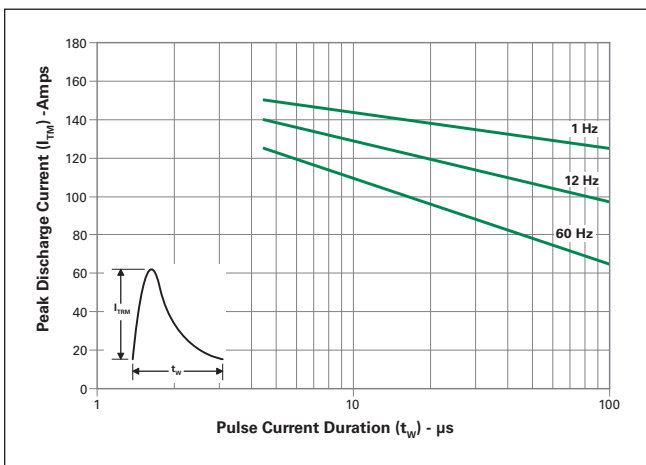
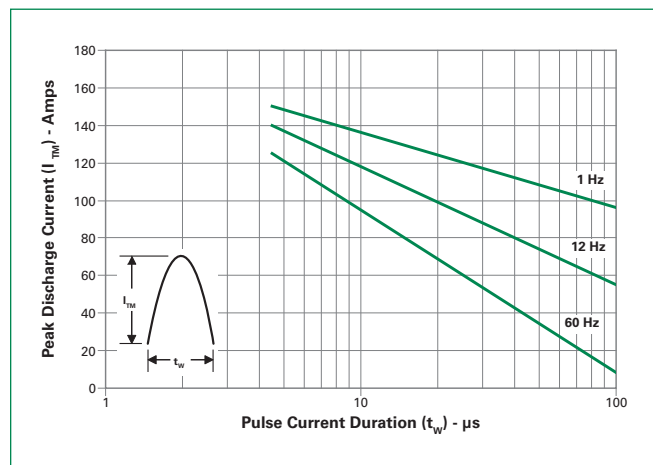
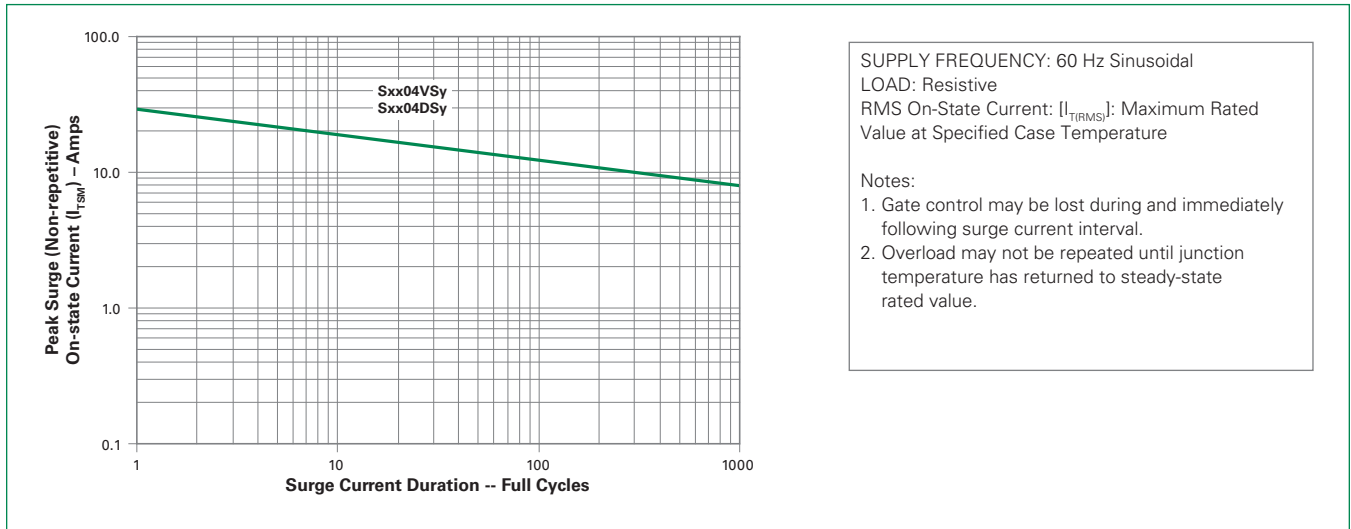

Figure 12: Peak Repetitive Sinusoidal Pulse Current



Note: xx = voltage, y = sensitivity

Figure 13: Surge Peak On-State Current vs. Number of Cycles



Note: xx or z - voltage, y = sensitivity

Figure 14: Simple Test Circuit for Gate Trigger Voltage and Current

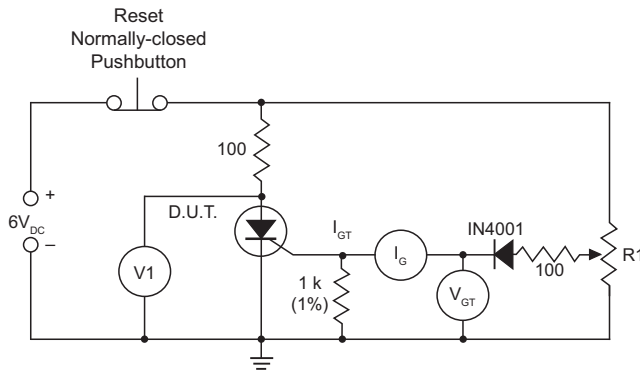

Note: V1 — 0 V to 10 V dc meter
 V_{GT} — 0 V to 1 V dc meter
 I_G — 0 mA to 1 mA dc milliammeter
 R1 — 1 k potentiometer

To measure gate trigger voltage and current, raise gate voltage (V_{GT}) until meter reading V1 drops from 6 V to 1 V. Gate trigger voltage is the reading on V_{GT} just prior to V1 dropping. Gate trigger current I_{GT} Can be computed from the relationship

$$I_{GT} = I_G \cdot \frac{V_{GT}}{1000} \text{ Amps}$$

where I_G is reading (in amperes) on meter just prior to V1 dropping

Note: I_{GT} may turn out to be a negative quantity (trigger current flows out from gate lead). If negative current occurs, I_{GT} value is not a valid reading. Remove 1 k resistor and use I_G as the more correct I_{GT} value. This will occur on 12 μ A gate products.

Soldering Parameters

Reflow Condition		Pb – Free assembly
Pre Heat	- Temperature Min ($T_{s(min)}$)	150°C
	- Temperature Max ($T_{s(max)}$)	200°C
	- Time (min to max) (t_s)	60 – 180 secs
Average ramp up rate (Liquidus Temp (T_L) to peak)		5°C/second max
$T_{s(max)}$ to T_L - Ramp-up Rate		5°C/second max
Reflow	- Temperature (T_L) (Liquidus)	217°C
	- Temperature (t_L)	60 – 150 seconds
Peak Temperature (T_p)		260 ^{+0/-5} °C
Time within 5°C of actual peak Temperature (t_p)		20 – 40 seconds
Ramp-down Rate		5°C/second max
Time 25°C to peak Temperature (T_p)		8 minutes Max.
Do not exceed		280°C

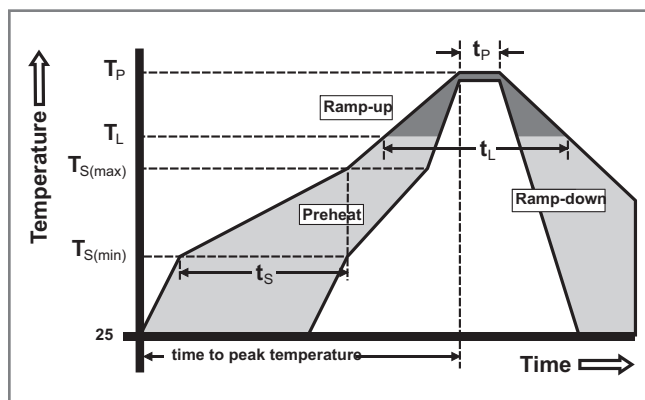

Physical Specifications

Terminal Finish	100% Matte Tin-plated
Body Material	UL recognized epoxy meeting flammability classification 94V-0
Lead Material	Copper Alloy

Design Considerations

Careful selection of the correct device for the application's operating parameters and environment will go a long way toward extending the operating life of the Thyristor. Good design practice should limit the maximum continuous current through the main terminals to 75% of the device rating. Other ways to ensure long life for a power discrete semiconductor are proper heat sinking and selection of voltage ratings for worst case conditions. Overheating, overvoltage (including dv/dt), and surge currents are the main killers of semiconductors. Correct mounting, soldering, and forming of the leads also help protect against component damage.

Environmental Specifications

Test	Specifications and Conditions
AC Blocking	MIL-STD-750, M-1040, Cond A Applied Peak AC voltage @ 125°C for 1008 hours , $R_{gk} = 1\text{kohms}$
Temperature Cycling	MIL-STD-750, M-1051, 100 cycles; -40°C to +150°C; 15-min dwell-time
Temperature/Humidity	EIA / JEDEC, JESD22-A101 1008 hours; 320V - DC: 85°C; 85% rel humidity
High Temp Storage	MIL-STD-750, M-1031, 1008 hours; 150°C
Low-Temp Storage	1008 hours; -40°C
Thermal Shock	MIL-STD-750, M-1056 10 cycles; 0°C to 100°C; 5-min dwelltime at each temperature; 10 sec (max) transfer time between temperature
Autoclave	EIA / JEDEC, JESD22-A102 168 hours (121°C at 2 ATMs) and 100% R/H
Resistance to Solder Heat	MIL-STD-750 Method 2031
Solderability	ANSI/J-STD-002, category 3, Test A
Lead Bend	MIL-STD-750, M-2036 Cond E

Dimensions — TO-251AA (V/I-Package) — V/I-PAK Through Hole

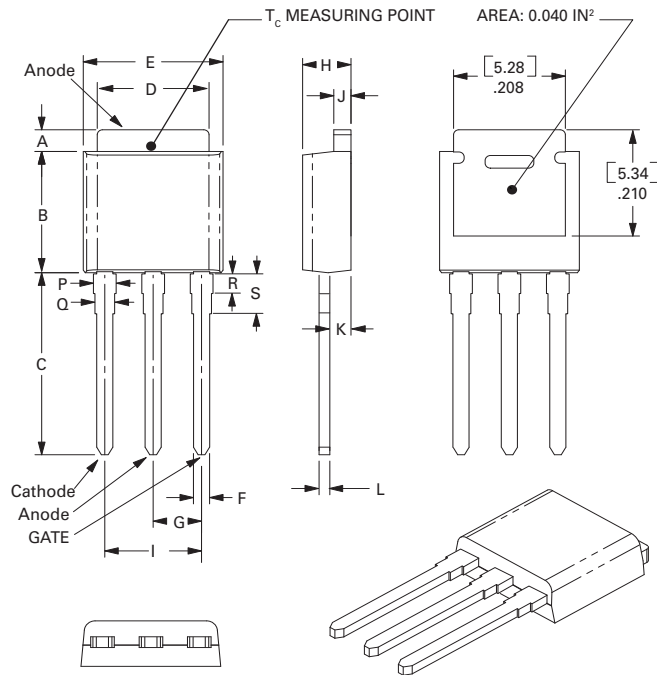

Dimension	Inches			Millimeters		
	Min	Typ	Max	Min	Typ	Max
A	0.040	0.044	0.050	1.02	1.11	1.27
B	0.235	0.242	0.245	5.97	6.15	6.22
C	0.350	0.361	0.375	8.89	9.18	9.53
D	0.205	0.208	0.213	5.21	5.29	5.41
E	0.255	0.262	0.265	6.48	6.66	6.73
F	0.027	0.031	0.033	0.69	0.80	0.84
G	0.087	0.090	0.093	2.21	2.28	2.36
H	0.085	0.092	0.095	2.16	2.34	2.41
I	0.176	0.180	0.184	4.47	4.57	4.67
J	0.018	0.020	0.023	0.46	0.51	0.58
K	0.038	0.040	0.044	0.97	1.01	1.12
L	0.018	0.020	0.023	0.46	0.52	0.58
P	0.042	0.047	0.052	1.06	1.20	1.32
Q	0.034	0.039	0.044	0.86	1.00	1.11
R	0.034	0.039	0.044	0.86	1.00	1.11
S	0.074	0.079	0.084	1.86	2.00	2.11

Dimensions — TO-252AA (D-Package) — D-PAK Surface Mount

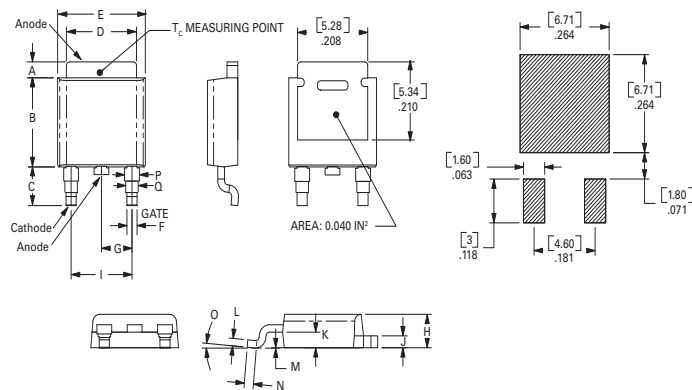

Dimension	Inches			Millimeters		
	Min	Typ	Max	Min	Typ	Max
A	0.040	0.043	0.050	1.02	1.09	1.27
B	0.235	0.243	0.245	5.97	6.16	6.22
C	0.106	0.108	0.113	2.69	2.74	2.87
D	0.205	0.208	0.213	5.21	5.29	5.41
E	0.255	0.262	0.265	6.48	6.65	6.73
F	0.027	0.031	0.033	0.69	0.80	0.84
G	0.087	0.090	0.093	2.21	2.28	2.36
H	0.085	0.092	0.095	2.16	2.33	2.41
I	0.176	0.179	0.184	4.47	4.55	4.67
J	0.018	0.020	0.023	0.46	0.51	0.58
K	0.038	0.040	0.044	0.97	1.02	1.12
L	0.018	0.020	0.023	0.46	0.51	0.58
M	0.000	0.000	0.004	0.00	0.00	0.10
N	0.021	0.026	0.027	0.53	0.67	0.69
O	0°	0°	5°	0°	0°	5°
P	0.042	0.047	0.052	1.06	1.20	1.32
Q	0.034	0.039	0.044	0.86	1.00	1.11

4.0A SCRs

Product Selector

Part Number	Voltage				Gate Sensitivity	Type	Package
	400V	600V	800V	1000V			
Sxx04DS1	X	X			50µA	Sensitive SCR	TO-252
Sxx04DS2	X	X			200µA	Sensitive SCR	TO-252
Sxx04VS1	X	X			50µA	Sensitive SCR	TO-251
Sxx04VS2	X	X			200µA	Sensitive SCR	TO-251

Note: xx = Voltage

Packing Options

Part Number	Marking	Weight	Packing Mode	Base Quantity
Sxx04DSyTP	Sxx04DSy	0.3g	Tube	750 (75 per tube)
Sxx04DSyRP	Sxx04DSy	0.3g	Embossed Carrier	2500
Sxx04VSyTP	Sxx04VSy	0.4g	Tube	750 (75 per tube)

Note: xx = voltage, y = sensitivity

TO-252 Embossed Carrier Reel Pack (RP) Specs

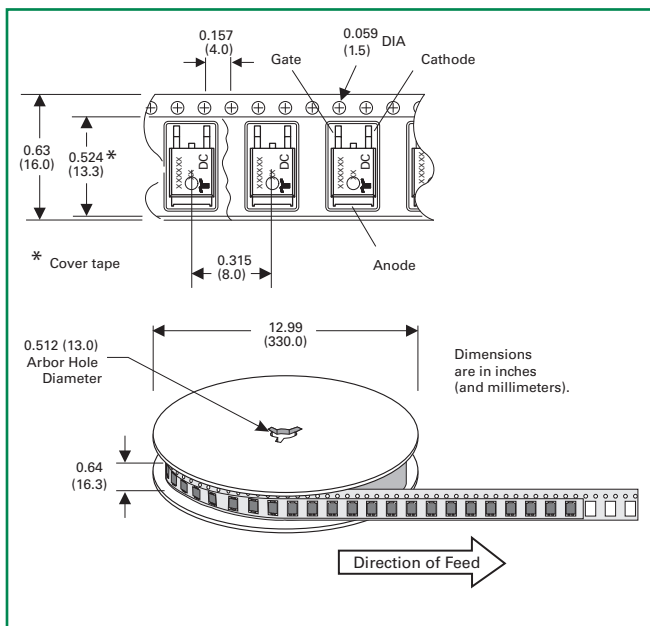

Part Marking System

TO-252AA – (D Package)
TO-251AA – (V Package)

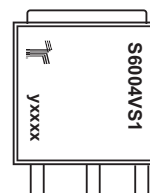

Part Numbering System

