

IEC Appliance Inlet C20 with Circuit Breaker TA35 1-pole



C20



70° C

**Description**

- Panel Mount:
  - Snap-in version from front side
- 2 Functions:
  - Appliance Inlet, Protection class I, Circuit breaker type TA35, 1-pole
- Quick connect terminals 6.3 x 0.8 mm
- Alternative: version for 10 A (15 A) [6135](#)
- Substitute for type [1624-K](#)

**Approvals**

- VDE License Number: 40025196
- UL License Number: E96454

**Characteristics**

- Unwired
- Switch non-illuminated or illuminated
- Thermal overload protection
- Qualified for use in equipment according IEC/EN 60950

**Other versions on request**

- Pre-wired version
- Quick-connect terminals 4.8 x 0.8 mm
- Protection class II, 70°C

**References**

[General Product Information](#)

**Weblinks**

[Approvals](#), [RoHS](#), [CHINA-RoHS](#), [e-Store](#), [SCHURTER-Stock-Check](#), [Distributor-Stock-Check](#)

**Technical Data**

Ratings IEC	16A / 250VAC; 50Hz
Ratings UL/CSA	20A / 250VAC; 60Hz
Dielectric Strength	> 2.5 kVAC between L-N > 3 kVAC between L/N-PE (1 min/50Hz)
Allowable Operation Temp.	-25 °C to 60 °C
Degree of Protection	from front side IP 40 acc. to IEC 60529
Protection Class	Suitable for appliances with protection class I acc. to IEC 61140
Terminal	Quick connect terminals 6.3 x 0.8 mm
Panel Thickness s	Snap-in: 1.5/ 2/ 2.5 mm
Material: Housing	Thermoplastic, black, UL 94V-0

Appliance-Inlet/-Outlet	C20 acc. to IEC/EN 60320-1, UL 498, CSA C22.2 no. 42 (for cold conditions) pin-temperature 70 °C, 16A, Protection class I
Circuit breaker	Acc. IEC/EN 60934, UL 1077, CSA 22.2 no. 235 1-pole rocker switch, illuminated or non-illuminated. Conditional short circuit Inc: 2000 A

## Dimensions

Length |-----| 53.6 mm

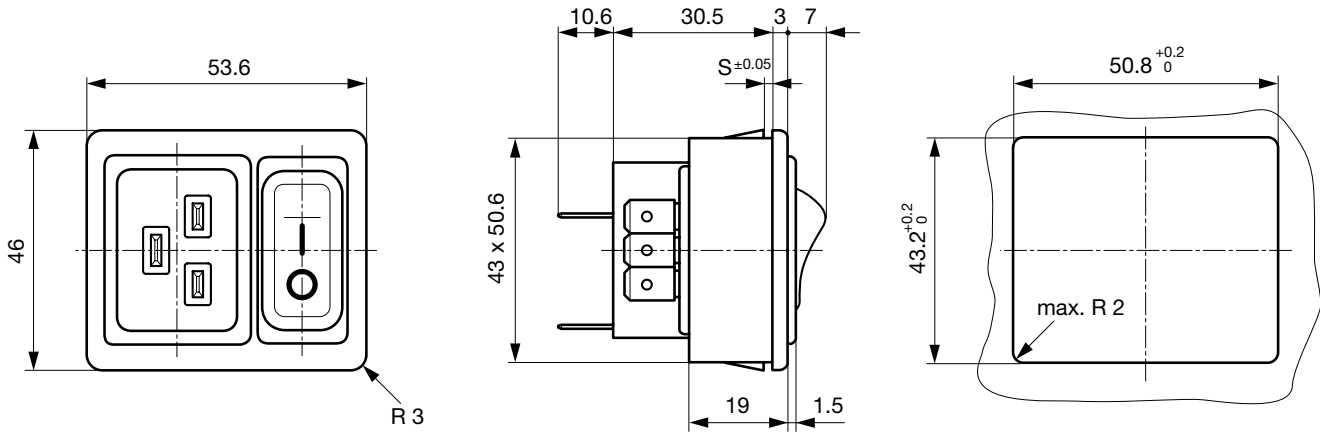

## Diagrams

non-illuminated

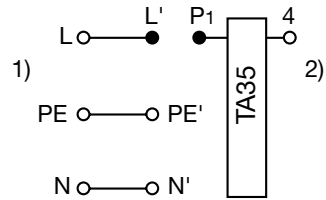

- 1) Line
- 2) Load

illuminated (connection N' to L)

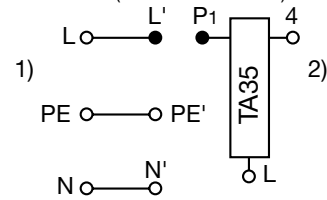

- 1) Line
- 2) Load

**ORDER CODE**

**Table 1 Selection for type TA35**

Order example

Number of switched poles	<b>1-pole</b>	
Number of protected poles	<b>1</b>	
Switch without illumination	<b>CFT</b>	
Switch illuminated 240 V 120 V	<b>C2F</b> <b>C4F</b>	
Other versions on request		

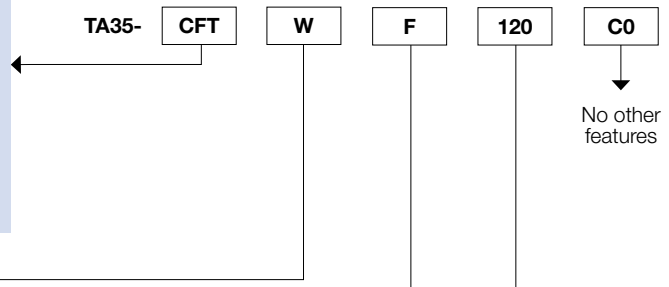

**Colours**

	Switch front	Rocker	
		non-illuminated	illuminated
<b>W</b>	black	white	–
<b>B</b>	black	black	–
<b>3</b>	black	–	red transparent
<b>4</b>	black	–	green transparent
<b>6</b>	black	–	orange transparent

Other colours on request

**Rocker legend**

	Surface	Illustration		Colour of print
<b>F</b>	embossed	–	o	
<b>H</b>	printed	ON	OFF	white
<b>K</b>	printed	ON	OFF	black
<b>L</b>	printed	–	o	white
<b>M</b>	printed	–	o	black

Other legends on request

Position of the rocker legend e.g. F

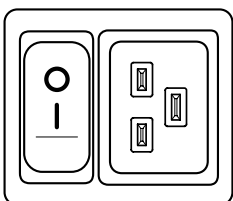

**Rated current I<sub>n</sub> (A)**

I <sub>n</sub>	Code	I <sub>n</sub>	Code
1,0	<b>J10</b>	8,0	<b>080</b>
2,0	<b>J20</b>	10,0	<b>100</b>
4,0	<b>040</b>	12,0	<b>120</b>
5,0	<b>050</b>	15,0	<b>150</b>
6,0	<b>060</b>	16,0	<b>160</b>
		20,0	<b>200*</b>

Other rated currents on request      \*) UL / CSA only

## Technical data (continued)

### Circuit breaker

Tripping characteristics

$I_n < 3 \text{ A}$

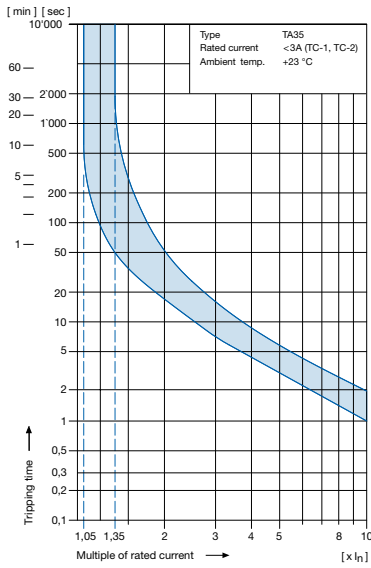

Tripping characteristics

$I_n \geq 3 \dots 20 \text{ A}$

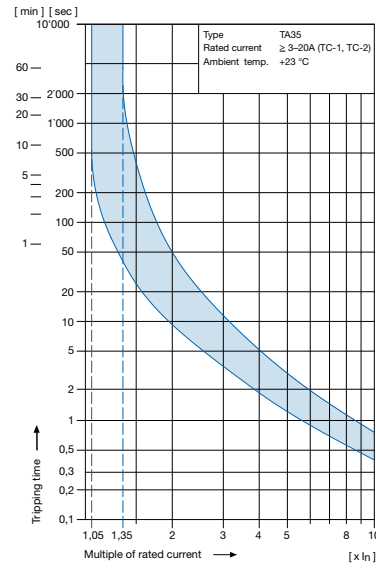

### Effect of ambient temperature

The unit is calibrated for an ambient temperature of +23 °C. To determine the rated current for lower or higher ambient temperature, use a correction factor from the table below.

* Ambient temperature [°C]	Correction factor
-25	0.79
-20	0.81
0	0.90
+23	1.00
+40	1.03
+50	1.04
+60	1.06

\* Temperature must be measured at the rear of the breaker next to the terminals after equipment operating temperature has been reached.

#### Example:

Rated current at +23 °C                    10 A  
 Ambient temperature                    +60 °C  
 Correction factor                            1.06  
 Chosen rated current at +60 °C  
 ambient temperature:                    **10 A x 1.06 = 10.6 A**

### Order code (Order example)

<b>Type</b>	<b>Order code TA35</b>	
<b>6136</b>	<b>C F T W F 1 2 0 C 0</b> see table 1	

**Wiring**  
 1 wired  
 0 unwired

**Terminals**  
 1 Quick connect 6.3 x 0.8 mm

**Mounting**  
 2 Snap-in s = 1.5 mm  
 3 Snap-in s = 2.0 mm  
 4 Snap-in s = 2.5 mm

0 Protection class 1

Please note that Schurter will establish an internal part number for logistics use in addition to the order code. The format of this internal part number is, for example: 6136.xxxx.xxxx

**Packaging unit** 15 Pcs

**Mating Outlets/Connectors**

Category / Description

Connector



IEC Connector C19, Rewireable, Straight	0104
IEC Connector C19, Rewireable, Angled	1651
IEC Connector C19, Rewireable, Straight	1652
IEC Connector C19, Rewireable, Angled	4790
IEC Connector C19, Rewireable, Straight	4795



Power Cord

Power Cord with IEC Connector C19, Straight	1654
---	------



Power Supply or Interconnection Cord

Diverse Netzanschluss- oder Netzweiterverbidungsleitung 16 A	6009.5195
--	-----------