

BSS 119

SIPMOS® Small-Signal Transistor

- N channel
- Enhancement mode
- $V_{GS(th)} = 1.6 \dots 2.6 \text{ V}$

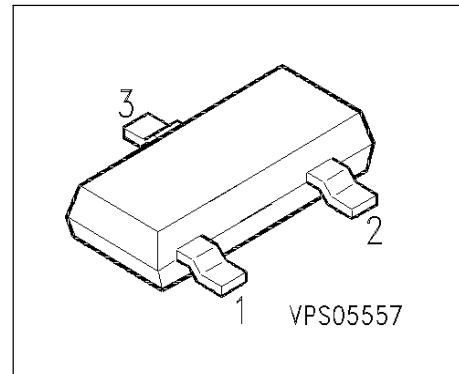

Pin 1	Pin 2	Pin 3
G	S	D

Type	V_{DS}	I_D	$R_{DS(on)}$	Package	Marking
BSS 119	100 V	0.17 A	6 Ω	SOT-23	sSH

Type	Ordering Code	Tape and Reel Information
BSS 119	Q67000-S007	E6327

Maximum Ratings

Parameter	Symbol	Values	Unit
Drain source voltage	V_{DS}	100	V
Drain-gate voltage $R_{GS} = 20 \text{ k}\Omega$	V_{DGR}	100	
Gate source voltage	V_{GS}	± 20	
ESD Sensitivity (HBM) as per MIL-STD 883		Class 1	
Continuous drain current $T_A = 28 \text{ }^\circ\text{C}$	I_D	0.17	A
DC drain current, pulsed $T_A = 25 \text{ }^\circ\text{C}$	I_{Dpuls}	0.68	
Power dissipation $T_A = 25 \text{ }^\circ\text{C}$	P_{tot}	0.36	W

Maximum Ratings

Parameter	Symbol	Values	Unit
Chip or operating temperature	T_j	-55 ... + 150	°C
Storage temperature	T_{stg}	-55 ... + 150	
Thermal resistance, chip to ambient air ¹⁾	R_{thJA}	≤ 350	K/W
Thermal resistance, chip-substrate- reverse side ¹⁾	R_{thJSR}	≤ 285	
DIN humidity category, DIN 40 040		E	
IEC climatic category, DIN IEC 68-1		55 / 150 / 56	

1) For package mounted on aluminium 15 mm x 16.7 mm x 0.7 mm

Electrical Characteristics, at $T_j = 25^\circ\text{C}$, unless otherwise specified

Parameter	Symbol	Values			Unit
		min.	typ.	max.	

Static Characteristics

Drain- source breakdown voltage $V_{GS} = 0\text{ V}, I_D = 0.25\text{ mA}, T_j = 25^\circ\text{C}$	$V_{(BR)DSS}$	100	-	-	V
Gate threshold voltage $V_{GS}=V_{DS}, I_D = 1\text{ mA}$	$V_{GS(th)}$	1.6	2	2.6	
Zero gate voltage drain current $V_{DS} = 100\text{ V}, V_{GS} = 0\text{ V}, T_j = 25^\circ\text{C}$ $V_{DS} = 100\text{ V}, V_{GS} = 0\text{ V}, T_j = 125^\circ\text{C}$ $V_{DS} = 60\text{ V}, V_{GS} = 0\text{ V}, T_j = 25^\circ\text{C}$	I_{DSS}	-	0.05 0.5 -	0.5 5 100	μA nA
Gate-source leakage current $V_{GS} = 20\text{ V}, V_{DS} = 0\text{ V}$	I_{GSS}	-	10	100	nA
Drain-Source on-state resistance $V_{GS} = 10\text{ V}, I_D = 0.17\text{ A}$ $V_{GS} = 4.5\text{ V}, I_D = 0.17\text{ A}$	$R_{DS(on)}$	-	4 6	6 10	Ω

Electrical Characteristics, at $T_j = 25^\circ\text{C}$, unless otherwise specified

Parameter	Symbol	Values			Unit
		min.	typ.	max.	

Dynamic Characteristics

Transconductance $V_{DS} \geq 2 * I_D * R_{DS(on)max}$, $I_D = 0.17\text{ A}$	g_{fs}	0.1	0.2	-	S
Input capacitance $V_{GS} = 0\text{ V}$, $V_{DS} = 25\text{ V}$, $f = 1\text{ MHz}$	C_{iss}	-	70	95	pF
Output capacitance $V_{GS} = 0\text{ V}$, $V_{DS} = 25\text{ V}$, $f = 1\text{ MHz}$	C_{oss}	-	10	15	
Reverse transfer capacitance $V_{GS} = 0\text{ V}$, $V_{DS} = 25\text{ V}$, $f = 1\text{ MHz}$	C_{rss}	-	4	6	
Turn-on delay time $V_{DD} = 30\text{ V}$, $V_{GS} = 10\text{ V}$, $I_D = 0.28\text{ A}$ $R_{GS} = 50\ \Omega$	$t_{d(on)}$	-	4	6	ns
Rise time $V_{DD} = 30\text{ V}$, $V_{GS} = 10\text{ V}$, $I_D = 0.28\text{ A}$ $R_{GS} = 50\ \Omega$	t_r	-	5	8	
Turn-off delay time $V_{DD} = 30\text{ V}$, $V_{GS} = 10\text{ V}$, $I_D = 0.28\text{ A}$ $R_{GS} = 50\ \Omega$	$t_{d(off)}$	-	12	16	
Fall time $V_{DD} = 30\text{ V}$, $V_{GS} = 10\text{ V}$, $I_D = 0.28\text{ A}$ $R_{GS} = 50\ \Omega$	t_f	-	12	16	

Electrical Characteristics, at $T_j = 25^\circ\text{C}$, unless otherwise specified

Parameter	Symbol	Values			Unit
		min.	typ.	max.	
Reverse Diode					
Inverse diode continuous forward current $T_A = 25^\circ\text{C}$	I_S	-	-	0.17	A
Inverse diode direct current, pulsed $T_A = 25^\circ\text{C}$	I_{SM}	-	-	0.68	
Inverse diode forward voltage $V_{GS} = 0\text{ V}, I_F = 0.34\text{ A}, T_j = 25^\circ\text{C}$	V_{SD}	-	0.85	1.3	V

Power dissipation

$P_{tot} = f(T_A)$

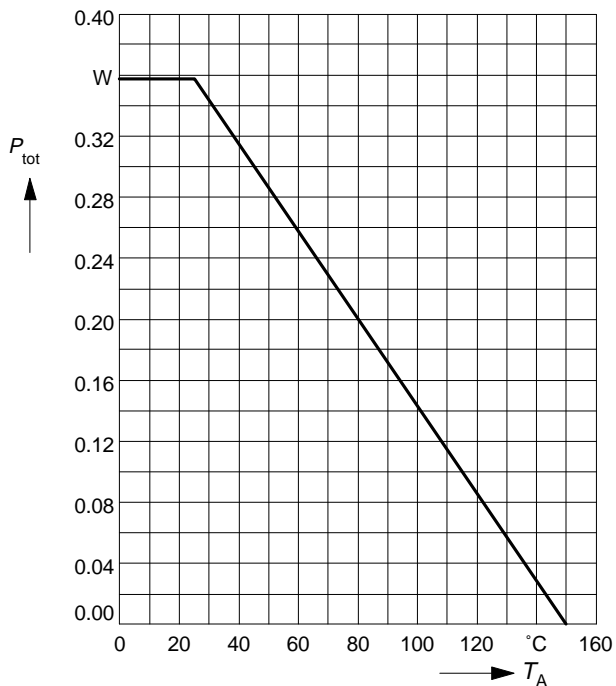

Drain current

$I_D = f(T_A)$

parameter: $V_{GS} \geq 10$ V

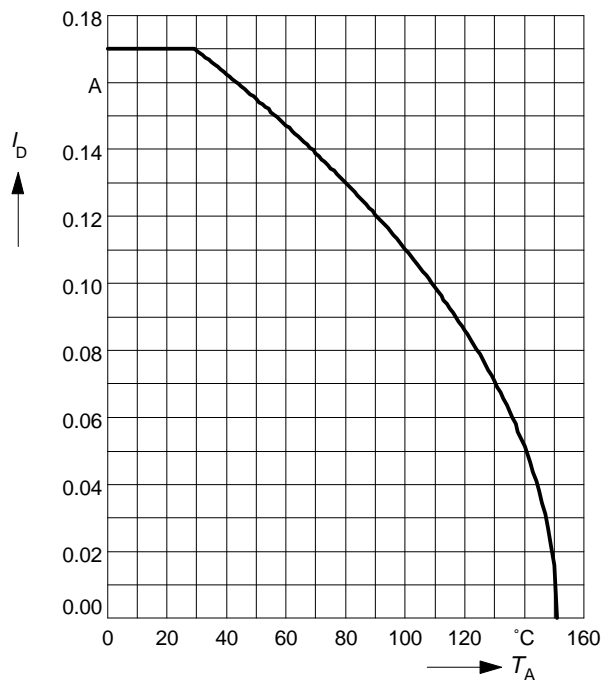

Safe operating area $I_D=f(V_{DS})$

parameter : $D = 0.01$, $T_C=25^\circ\text{C}$

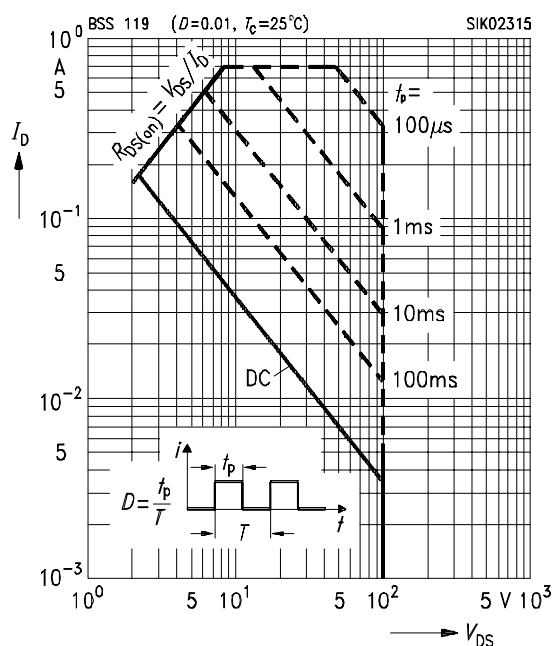

Drain-source breakdown voltage

$V_{(BR)DSS} = f(T_j)$

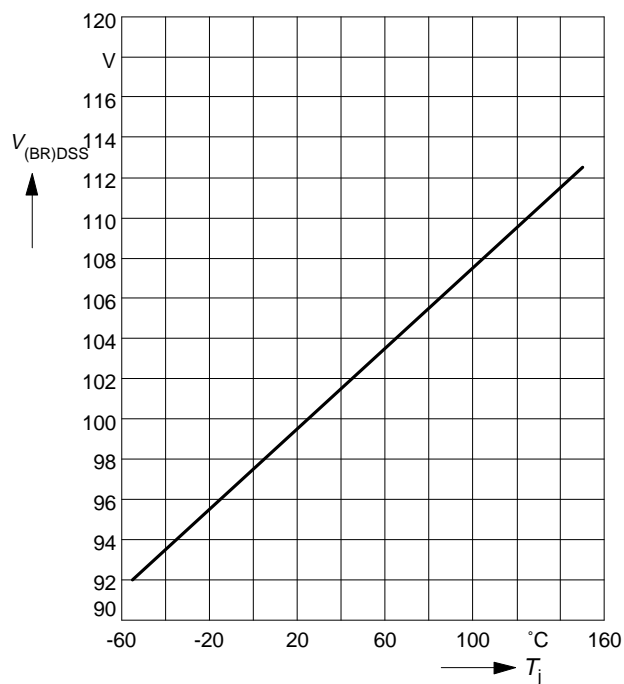

Typ. output characteristics

$I_D = f(V_{DS})$

parameter: $t_p = 80 \mu s$

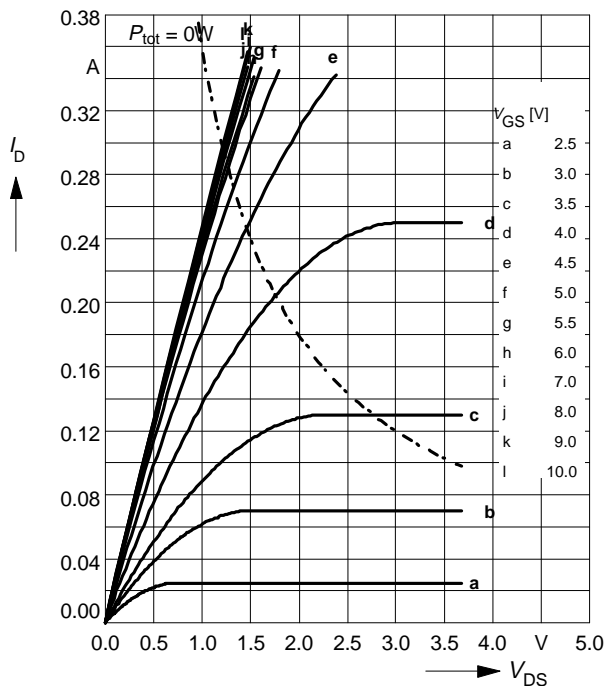

Typ. drain-source on-resistance

$R_{DS(on)} = f(I_D)$

parameter: $t_p = 80 \mu s, T_j = 25^\circ C$

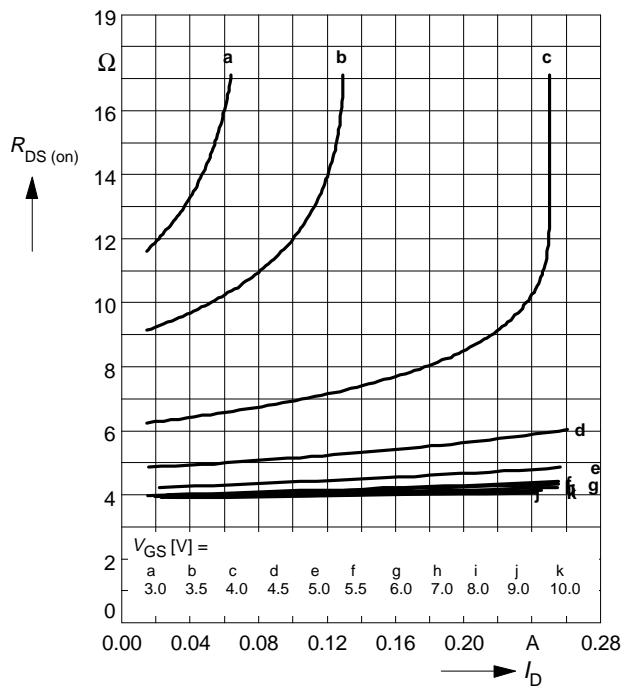

Typ. transfer characteristics $I_D = f(V_{GS})$

parameter: $t_p = 80 \mu s$

$V_{DS} \geq 2 \times I_D \times R_{DS(on)max}$

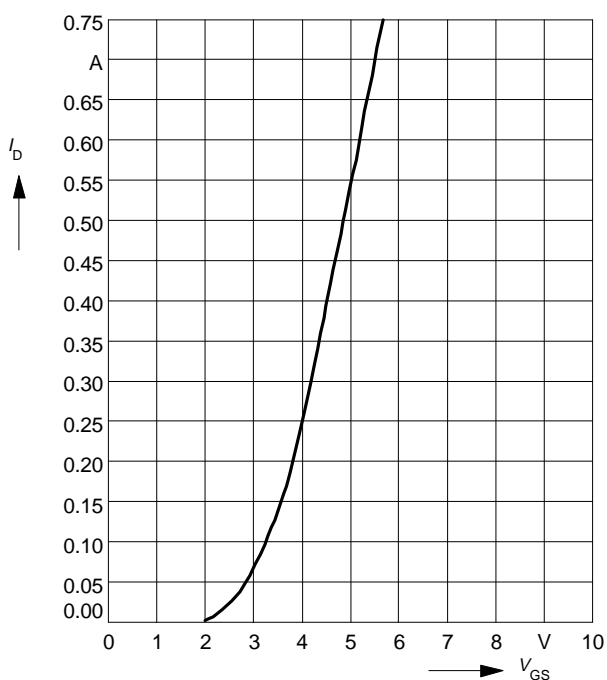

Typ. forward transconductance $g_{fs} = f(I_D)$

parameter: $t_p = 80 \mu s,$

$V_{DS} \geq 2 \times I_D \times R_{DS(on)max}$

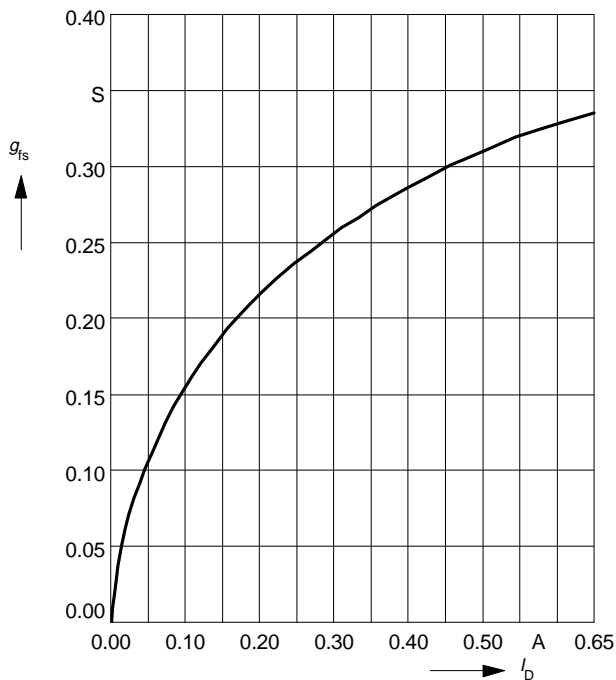

Drain-source on-resistance

$$R_{DS(on)} = f(T_j)$$

parameter: $I_D = 0.17\text{ A}$, $V_{GS} = 10\text{ V}$

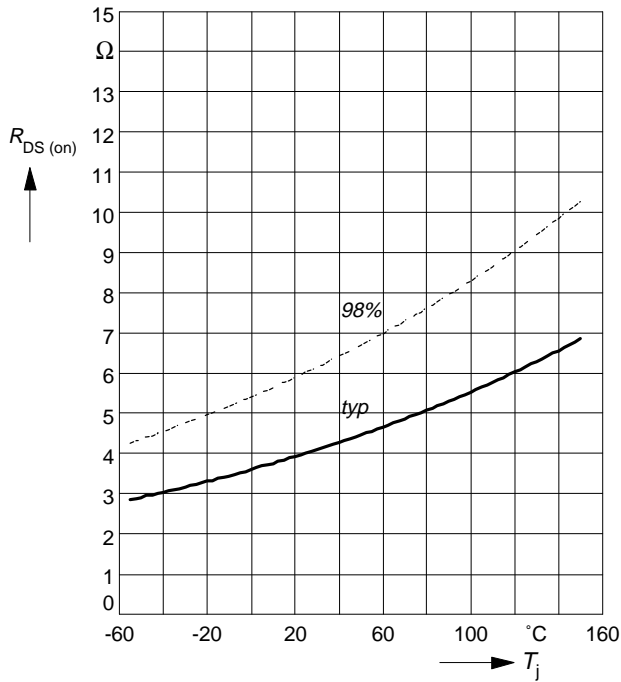

Gate threshold voltage

$$V_{GS(th)} = f(T_j)$$

parameter: $V_{GS} = V_{DS}$, $I_D = 1\text{ mA}$

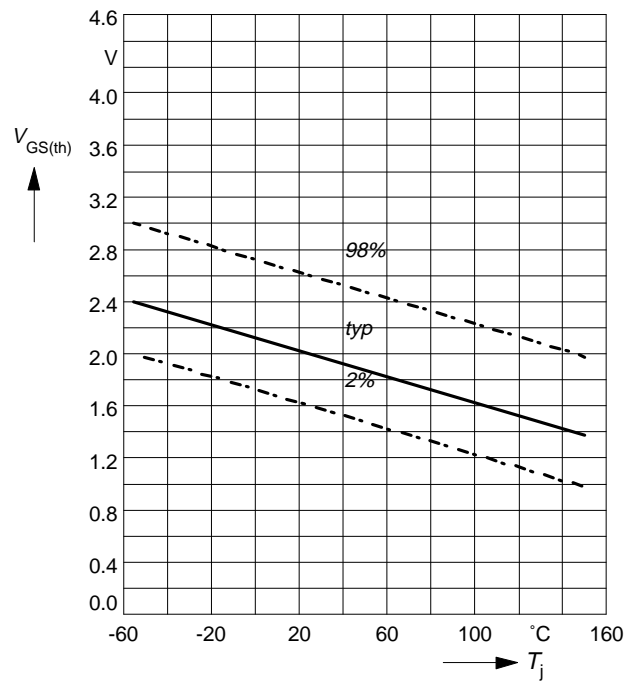

Typ. capacitances

$$C = f(V_{DS})$$

parameter: $V_{GS} = 0\text{ V}$, $f = 1\text{ MHz}$

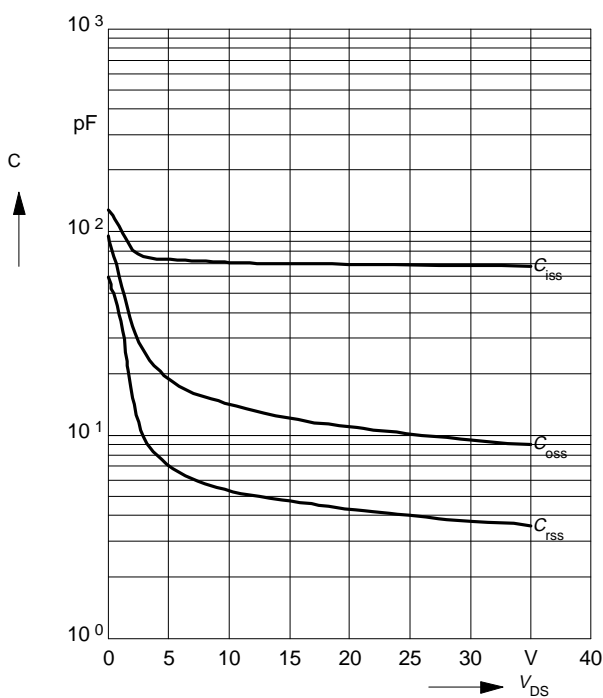

Forward characteristics of reverse diode

$$I_F = f(V_{SD})$$

parameter: $T_j, t_p = 80\text{ }\mu\text{s}$

