

### FEATURES

- Input Frequency (~22 MHz)
- Low Voltage Operation (2.3 to 5.5 V)
- Battery Save Function
- Wide Band Demodulator (~1 MHz)
- Very Small Package (SSOP-12)

### APPLICATIONS

- Communications Equipment
- Wireless LAN
- Keyless Entry Systems

### DESCRIPTION

The TK14584M is a standard function general purpose IF IC capable of operating up to 22 MHz. The TK14584M has a unique function that allows establishing the demodulation characteristics by changing the external RC time constant, and not changing the phase shifter constant. The RSSI output is individually trimmed, resulting in excellent accuracy, good linearity, and stable temperature characteristics. The TK14584M was developed for high-speed data communication, DECT, wireless LAN, keyless entry systems, etc.

The TK14584M is available in the very small SSOP-12 surface mount package.

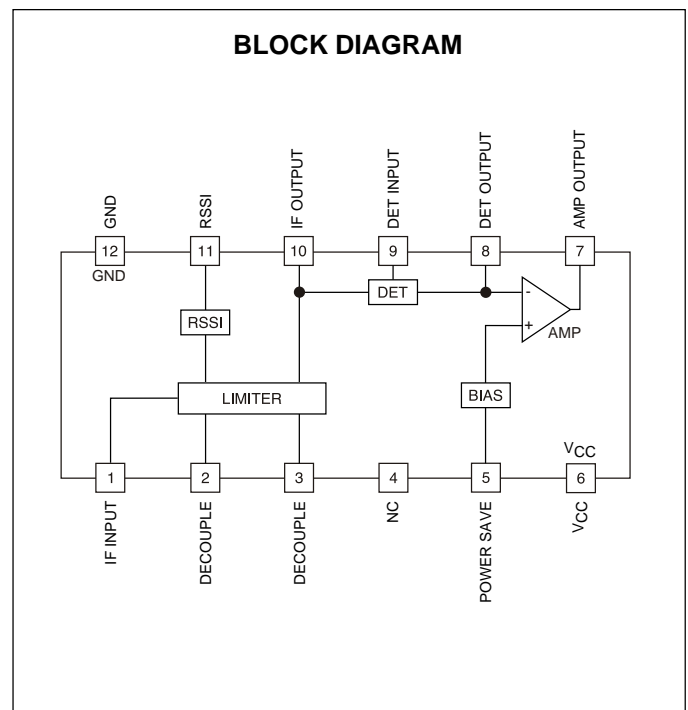
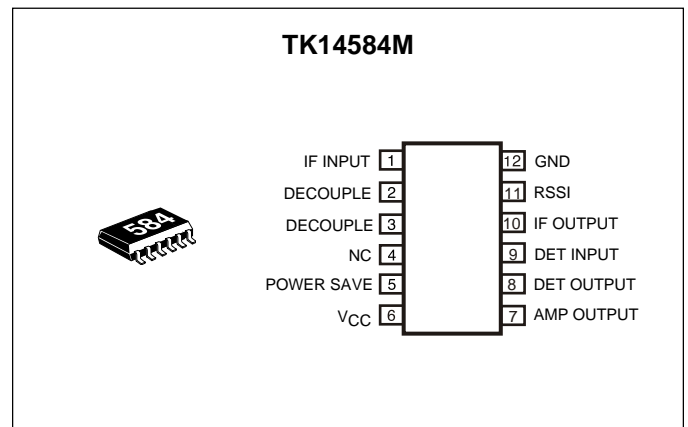

**ORDERING INFORMATION**

TK14584M □□

└─ Tape/Reel Code

TAPE/REEL CODE  
TL: Tape Left

# TK14584

## ABSOLUTE MAXIMUM RATINGS

Supply Voltage .....	6 V	Storage Temperature Range .....	-55 to +150 °C
Operating Voltage Range .....	2.3 to 5.5 V	Operating Temperature Range .....	-30 to +85 °C
Power Dissipation (Note 1) .....	250 mW	Operating Frequency Range (IF) .....	6 to 22 MHz
		Operating Frequency Range (Demodulation) .....	to 1 MHz

## TK14584M ELECTRICAL CHARACTERISTICS

Test conditions:  $V_{CC} = 3\text{ V}$ ,  $f_{IN} = 10.7\text{ MHz}$ ,  $f_m = 1\text{ kHz}$ , Modulation =  $\pm 50\text{ kHz}$ ,  $T_A = 25\text{ °C}$ , unless otherwise specified.

SYMBOL	PARAMETER	TEST CONDITIONS	MIN	TYP	MAX	UNITS
$I_{CC}$	Supply Current	No input		3.5	5.0	mA
		Power Save = ON, No input		0.2	5.0	$\mu\text{A}$
<b>IF</b>						
$V_{OUT}$	Output Voltage	-30 dBm input	120	200	360	mVrms
THD	Total Harmonic Distortion	-30 dBm input		0.5	2.0	%
S/N	Signal to Noise Ratio	-30 dBm input	60	70		dB
SINAD	12 dB SINAD			-89	-83	dBm
$R_{IF(IN)}$	Limiter Input Resistance		1.4	1.8	2.2	$\text{k}\Omega$
G	Gain		69	75		dB
<b>RSSI</b>						
$V_{RSSI}$	RSSI Output Voltage	No input	0.00	0.20	0.30	V
		-60 dBm non-modulated input	0.40	0.55	0.70	V
		-30 dBm non-modulated input	1.05	1.20	1.40	V
		0 dBm non-modulated input	1.50	1.70	1.95	V

Note 1: Power dissipation is 250 mW when mounted as recommended. Derate at 2.0 mW/°C for operation above 25°C.

## TEST CIRCUIT

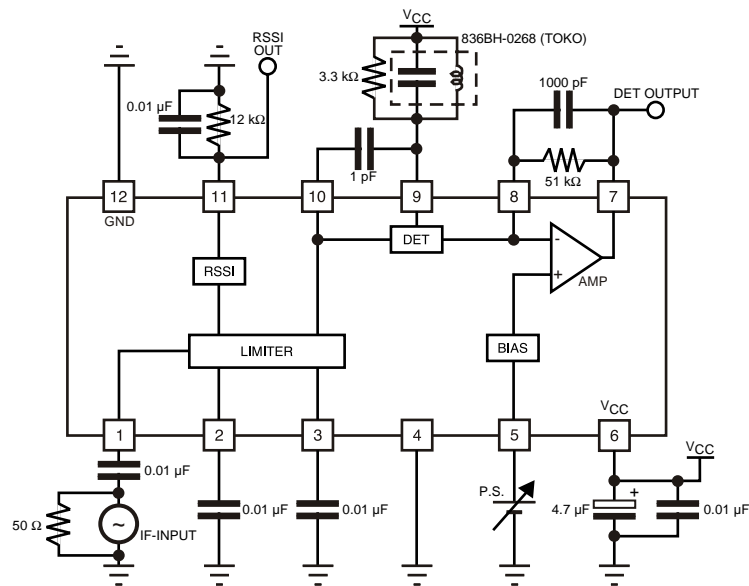

**TYPICAL PERFORMANCE CHARACTERISTICS**

$T_A = 25\text{ }^\circ\text{C}$ , unless otherwise specified.

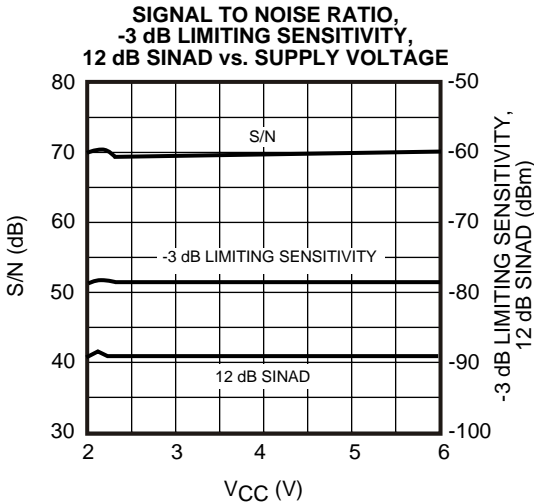
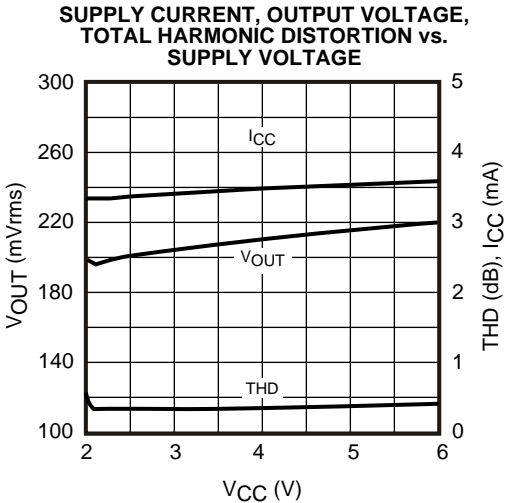
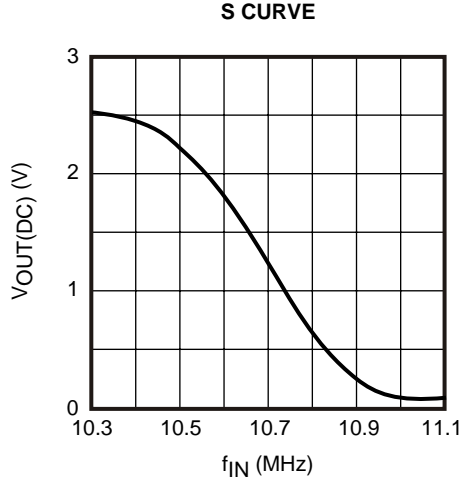
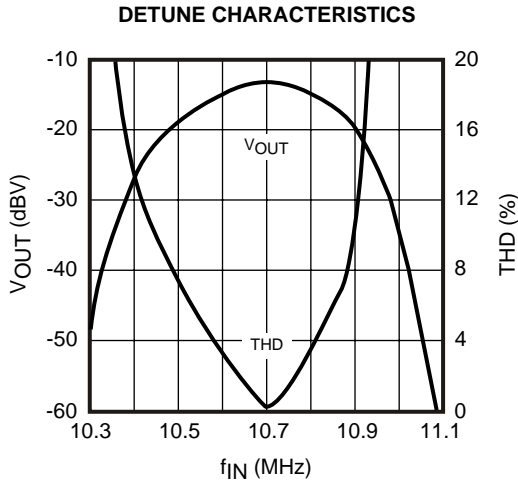
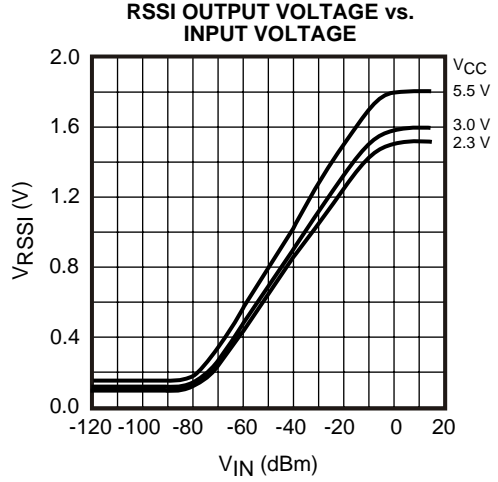
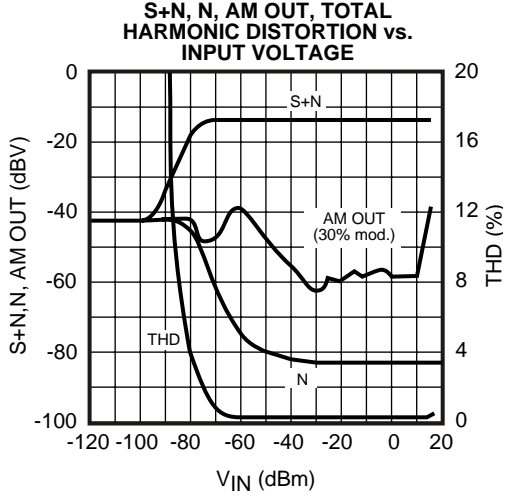

**TYPICAL PERFORMANCE CHARACTERISTICS (CONT.)**

$T_A = 25\text{ }^\circ\text{C}$ , unless otherwise specified.

**SUPPLY CURRENT, OUTPUT VOLTAGE, TOTAL HARMONIC DISTORTION vs. TEMPERATURE**

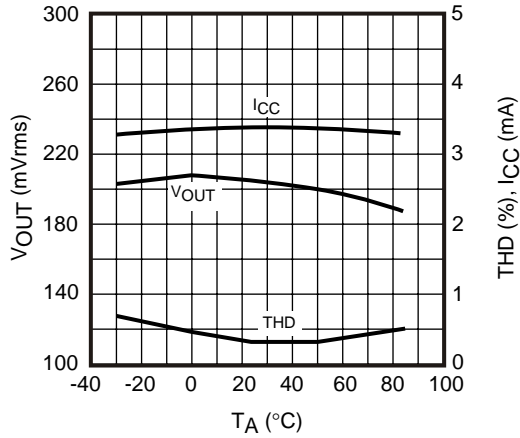

**SIGNAL TO NOISE RATIO, -3 dB LIMITING SENSITIVITY, 12 dB SINAD vs. TEMPERATURE**

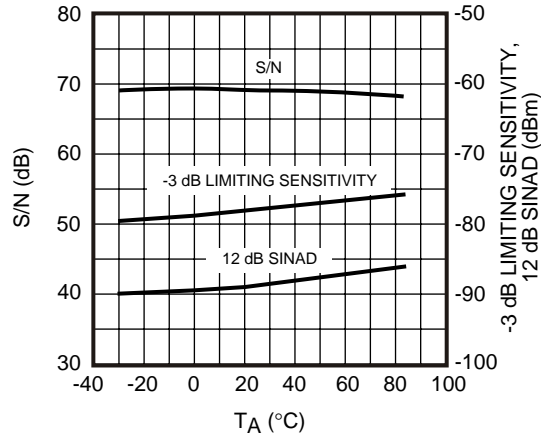

**LIMITER GAIN vs. INPUT FREQUENCY**

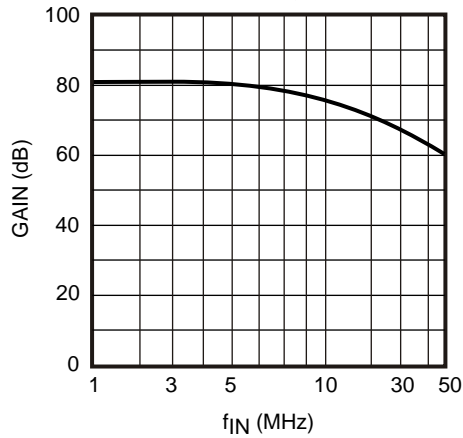

**RSSI OUTPUT VOLTAGE vs. TEMPERATURE**

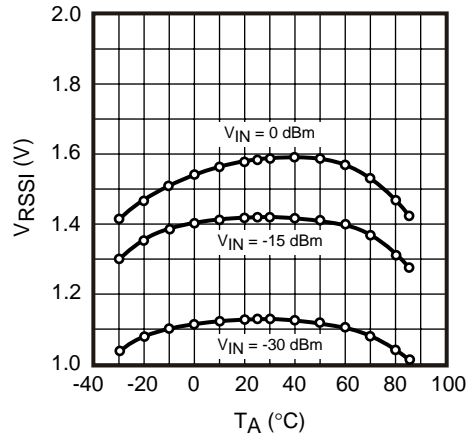

**RSSI OUTPUT VOLTAGE vs. TEMPERATURE**

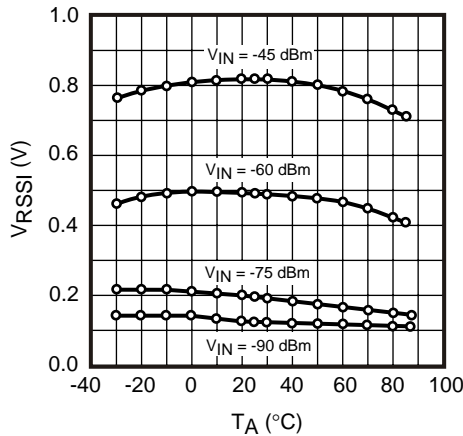

**RSSI OUTPUT VOLTAGE vs. INPUT VOLTAGE**

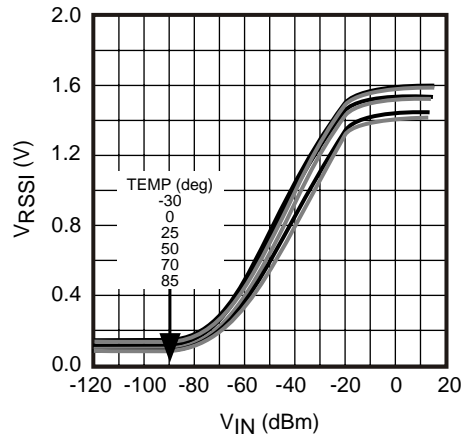

**TYPICAL PERFORMANCE CHARACTERISTICS (CONT.)**

$T_A = 25\text{ }^\circ\text{C}$ , unless otherwise specified.

**S CURVE**

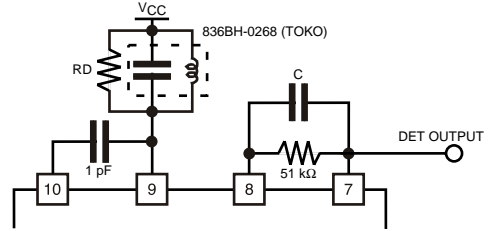
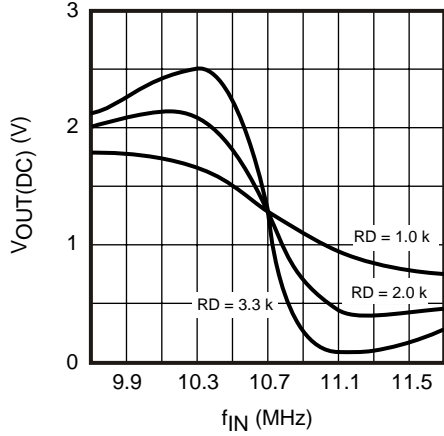

**OUTPUT VOLTAGE vs. MODULATING FREQUENCY**

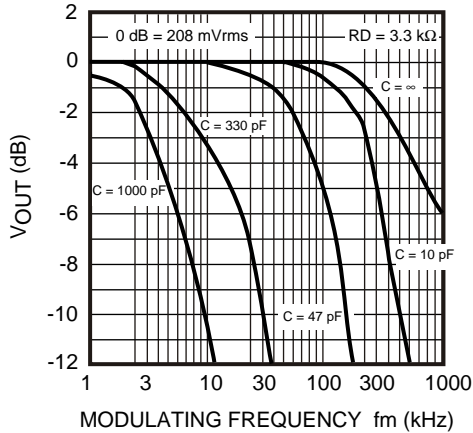

**OUTPUT VOLTAGE vs. MODULATING FREQUENCY**

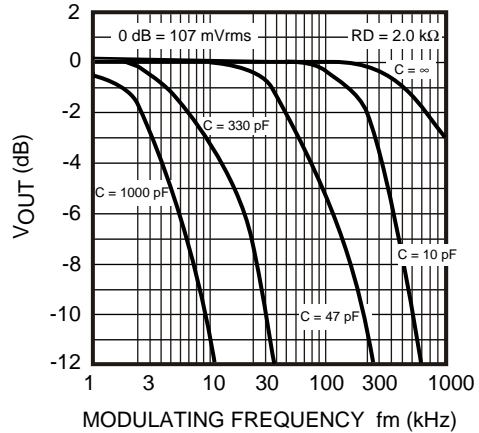

**OUTPUT VOLTAGE vs. MODULATING FREQUENCY**

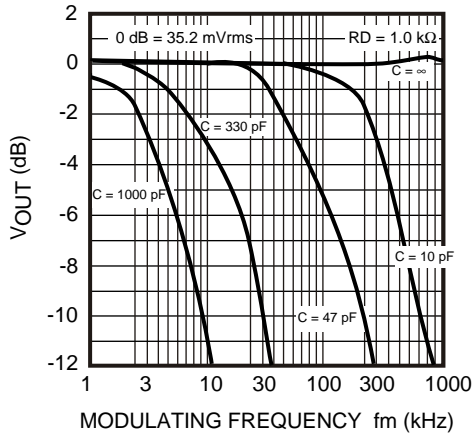

**TYPICAL PERFORMANCE CHARACTERISTICS (CONT.)**

$T_A = 25\text{ }^\circ\text{C}$ , unless otherwise specified.

**RSSI Output Voltage Transient Response (IF Input ON/OFF)**

IF INPUT VOLTAGE  
= -10, -40, -70 dBm

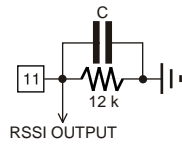

C = 0.01  $\mu\text{F}$

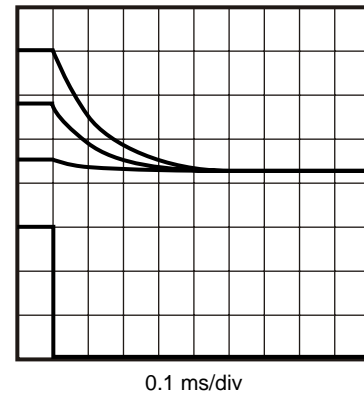
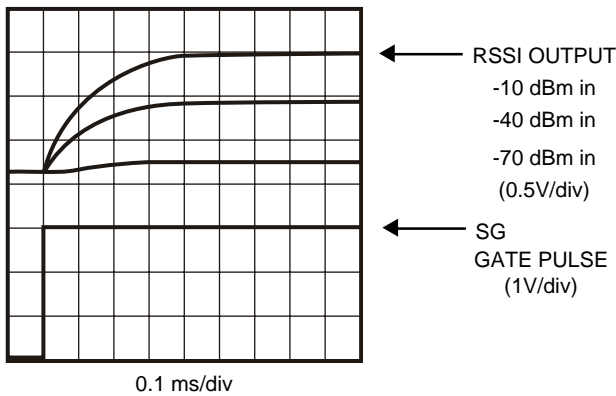

C = 0.001  $\mu\text{F}$

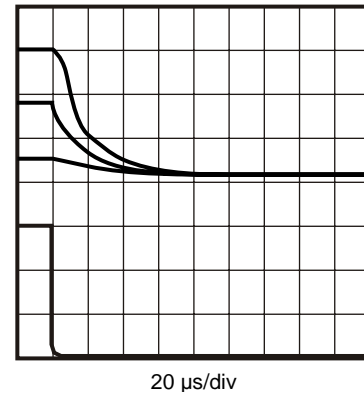
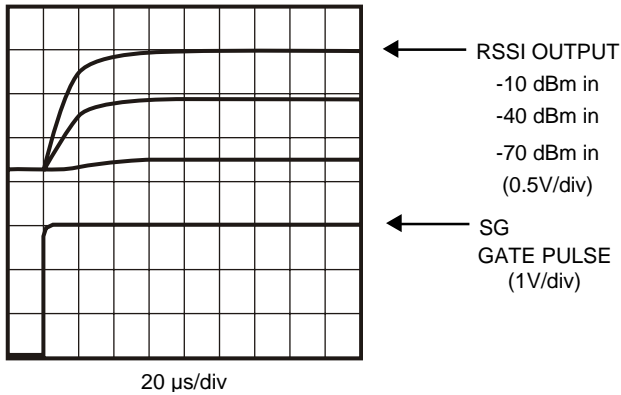

C = 0.0001  $\mu\text{F}$

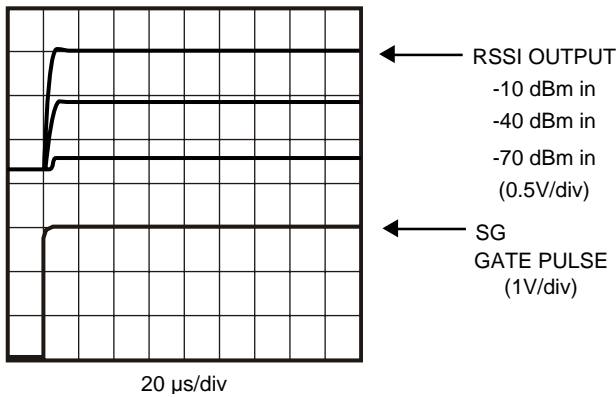

**TYPICAL PERFORMANCE CHARACTERISTICS (CONT.)**

$T_A = 25\text{ }^\circ\text{C}$ , unless otherwise specified.

**RSSI Output Voltage Transient Response (Power Save ON/OFF)**

IF INPUT VOLTAGE  
= -10, -40, -70 dBm

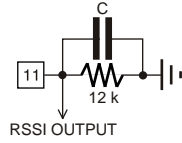

C = 0.01  $\mu\text{F}$

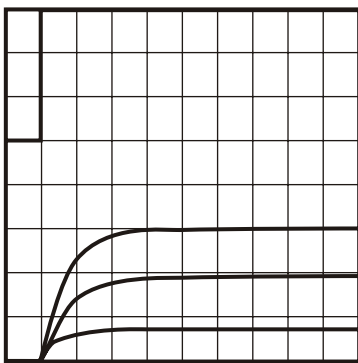

POWER SAVE  
(1V/div)

RSSI OUTPUT  
-10 dBm in  
-40 dBm in  
-70 dBm in  
(0.5V/div)

0.2 ms/div

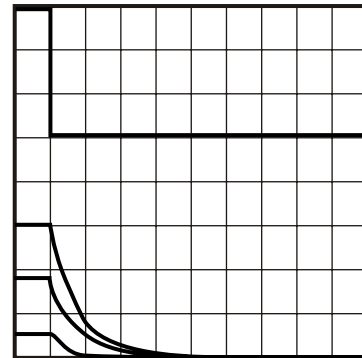

0.2 ms/div

C = 0.001  $\mu\text{F}$

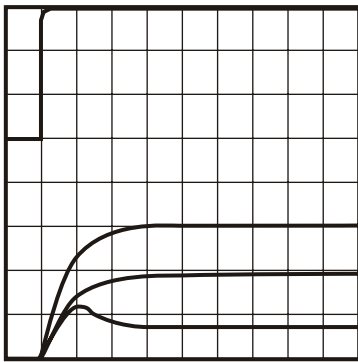

POWER SAVE  
(1V/div)

RSSI OUTPUT  
-10 dBm in  
-40 dBm in  
-70 dBm in  
(0.5V/div)

20  $\mu\text{s}$ /div

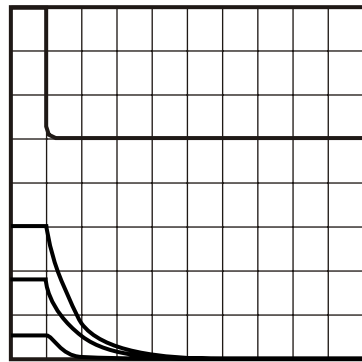

20  $\mu\text{s}$ /div

C = 0.0001  $\mu\text{F}$

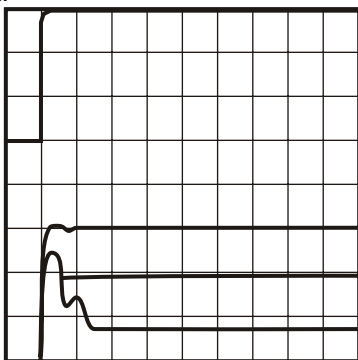

POWER SAVE  
(1V/div)

RSSI OUTPUT  
-10 dBm in  
-40 dBm in  
-70 dBm in  
(0.5V/div)

20  $\mu\text{s}$ /div

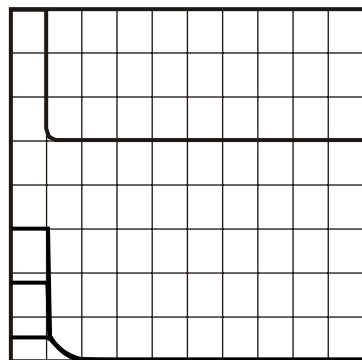

20  $\mu\text{s}$ /div



## TYPICAL PERFORMANCE CHARACTERISTICS (CONT.)

$T_A = 25\text{ }^\circ\text{C}$ , unless otherwise specified.

### RSSI Output Voltage Transient Response (Supply Voltage ON)

IF INPUT VOLTAGE  
= -10, -40, -70 dBm

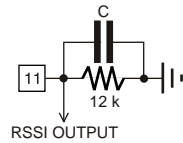

$C = 0.01\text{ }\mu\text{F}$

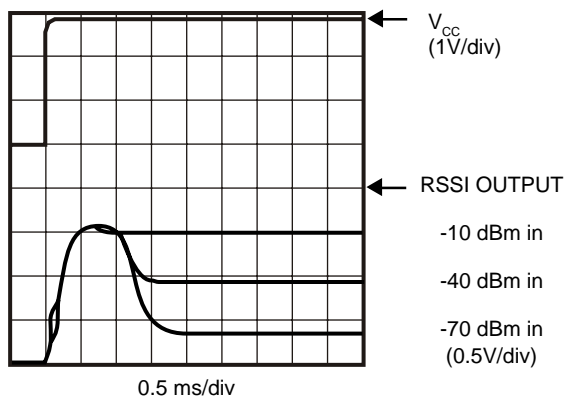

$C = 0.001\text{ }\mu\text{F}$

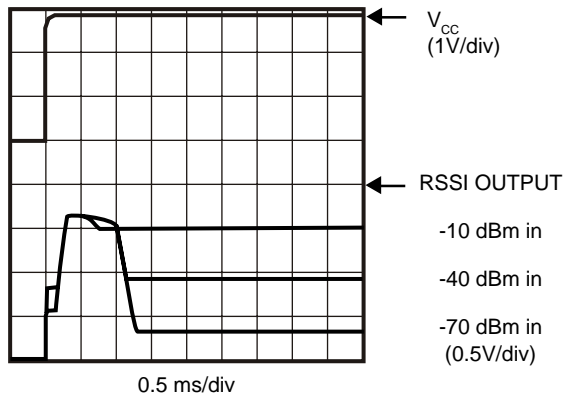

$C = 0.0001\text{ }\mu\text{F}$

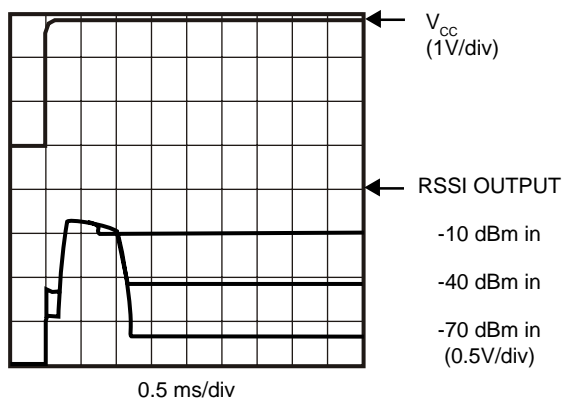

**TYPICAL PERFORMANCE CHARACTERISTICS (CONT.)**

$T_A = 25\text{ }^\circ\text{C}$ , unless otherwise specified.

**Detector Output Voltage Transient Response (Power Save ON/OFF, Supply Voltage ON)**

IF INPUT VOLTAGE  
= -40 dBm, No input

**POWER SAVE ON/OFF**

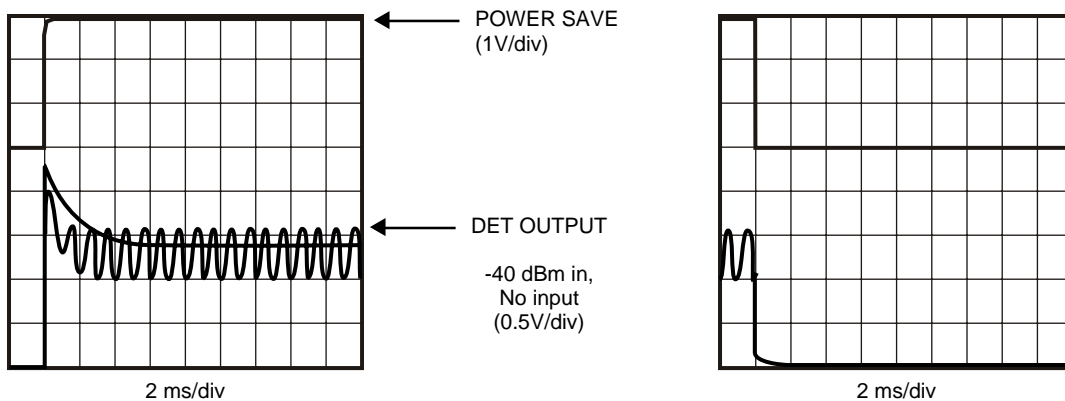

**SUPPLY VOLTAGE ON**

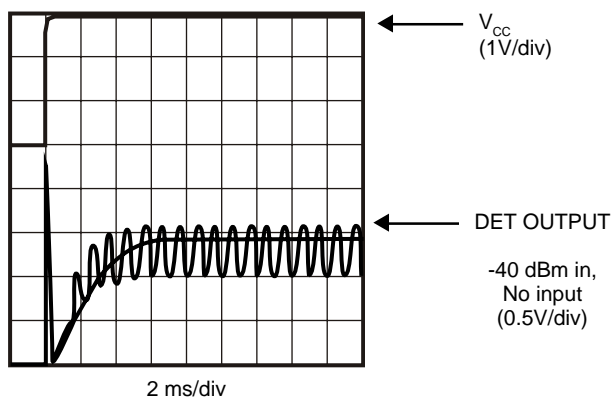

## PIN FUNCTION DESCRIPTION

TERMINAL			INTERNAL EQUIVALENT CIRCUIT	DESCRIPTION
PIN NO.	SYMBOL	VOLTAGE		
1 2 3	IF INPUT DECOUPLE DECOUPLE	1.9 V 1.9 V 1.9 V		1: Limiting Amp INPUT 2,3: Limiting Amp Decoupling
4	NC			No internal connection. However, this pin must be connected to GND for noise reduction.
5	POWER SAVE	$V_s$		Power Save On: $V_s < 0.3 V$  Power Save Off: $V_s = 1.5 V$ to $V_{CC}$
6	$V_{CC}$	3.0 V		
7 8	AMP OUTPUT DET OUTPUT	1.2 V 1.2 V		7: Amplifier Output 8: Detector Output
9	DET INPUT	3.0 V		Detector Input

**PIN FUNCTION DESCRIPTION**

TERMINAL			INTERNAL EQUIVALENT CIRCUIT	DESCRIPTION
PIN NO.	SYMBOL	VOLTAGE		
10	IF OUTPUT	1.9 V		IF Limiter Output
11	RSSI			RSSI Output
12	GND	0 V		

## CIRCUIT DESCRIPTION

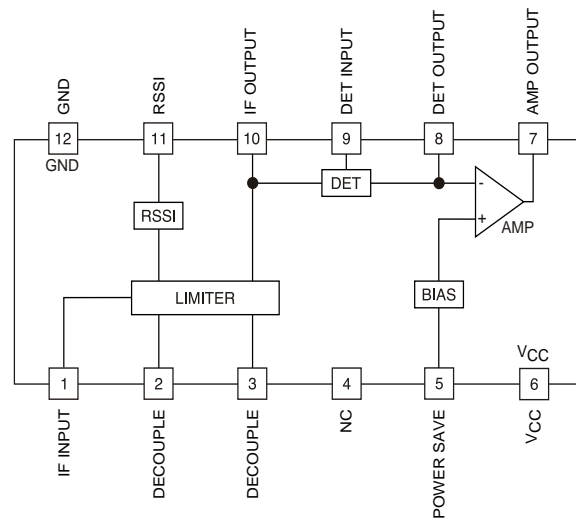

### IF Limiter Amplifier, RSSI:

The IF limiter amplifier is composed of five differential gain stages. The total gain of the IF limiter amplifier is 80 dB. The output signal of the IF limiter amplifier is provided at Pin 10 through the emitter-follower output stage. The IF limiter amplifier output level is  $0.5 V_{P-P}$ .

The input resistance of the IF limiter amplifier is 1.8 k $\Omega$  (see Figure 1A). If the impedance of the filter is lower than 1.8 k $\Omega$ , connect an external resistor between Pin 1 and Pin 2 in parallel to provide the equivalent load impedance of the filter. Figure 1A shows the case that the impedance of the filter is 330  $\Omega$ .

The operating current of the emitter-follower of the IF limiter amplifier output is 200  $\mu$ A. If the capacitive load is large, the negative half cycle of the output waveform may be distorted. This distortion can be reduced by connecting an external resistor between Pin 10 to GND to increase the operating current. The increased operating current from an external resistor is calculated as follows (see Figure 1B):

The increased operating current  $I_e$  (mA) =  $(V_{CC} - 1.0) / R_e$  (k $\Omega$ )

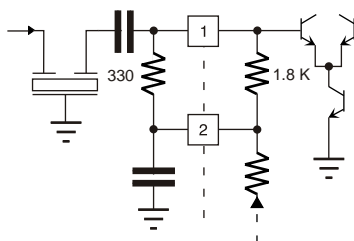

FIGURE 1A

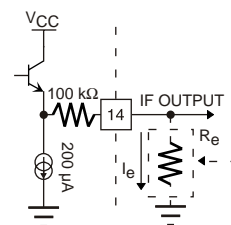

FIGURE 1B

## CIRCUIT DESCRIPTION (CONT.)

The RSSI output is a current output. It converts to a voltage by an external resistor between Pin 11 and GND. The time constant of the RSSI output is determined by the product of the external converting resistance and parallel capacitance. When the time constant is longer, the RSSI output is less likely to be influenced by a disturbance or component of amplitude modulation, but the RSSI output response is slower. The external resistance and capacitance are determined by the application.

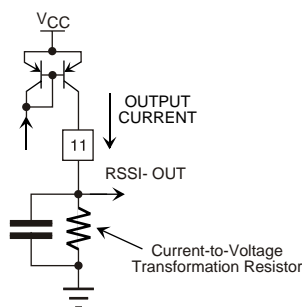

FIGURE 2 - RSSI OUTPUT STAGE

The slope of the RSSI curve characteristic can be modified by changing the external resistance. In this case, the maximum range of converted RSSI output voltage is GND level to about  $V_{CC} - 0.2\text{ V}$  (the supply voltage minus the collector saturation voltage of the output transistor).

In addition, the temperature characteristic of the RSSI output voltage can be modified by changing the temperature characteristic of the external resistor. Normally, the temperature characteristic of the RSSI output voltage is very stable when using a carbon resistor or metal film resistor with a temperature characteristic of 0 to 200 ppm/°C.

The RSSI output is trimmed individually for enhanced accuracy.

### AM Demodulation by Using the RSSI Output:

Although the distortion of the RSSI output is high because it is a logarithmic detection of the IF input envelope, AM can be demodulated simply by using the RSSI output. In this case, the input dynamic range that can demodulate AM is the inside of the linear portion of the RSSI curve characteristic (see Figure 3B).

This method does not have a feedback loop to control the gain because an AGC amplifier is not necessary (unlike the popularly used AM demodulation method). Therefore, it is a very useful for some applications because it does not have the response time problem.

Figure 3A shows the AM demodulated waveform.

## CIRCUIT DESCRIPTION (CONT.)

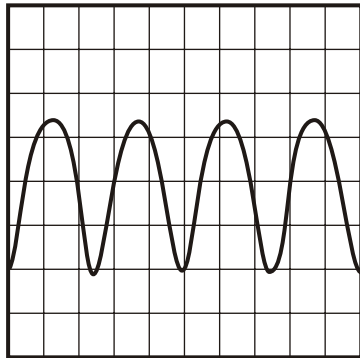

Operating Condition  
 $V_{CC} = 3\text{ V}$ ,  $f_{IN} = 10.7\text{ MHz}$ ,  
 $f_m = 40\text{ kHz}$ , Mod = 80%,  
 $V_{IN} = -40\text{ dBm}$

100mV/div  
 10 $\mu$ s/div

FIGURE 3A - AM DEMODULATED WAVEFORM

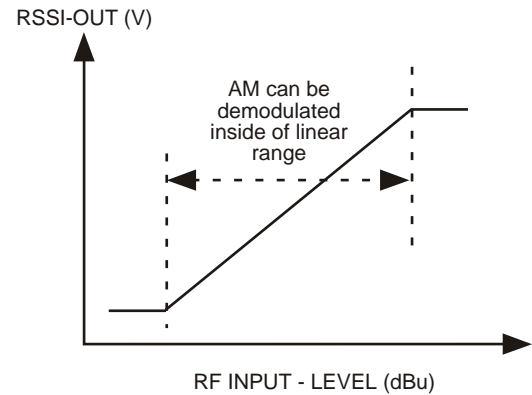

FIGURE 3B

### FM Detector:

The FM detector is included in the quadrature FM detector using a Gilbert multiplier.

It is suitable for high speed data communication because the demodulation bandwidth is over 1 MHz.

The phase shifter is connected between Pin 10 (IF limiter output) and Pin 9 (input detector). Any available phase shifter can be used: a LC resonance circuit, a ceramic discriminator, a delay line, etc.

Figure 4 shows the internal equivalent circuit of the detector.

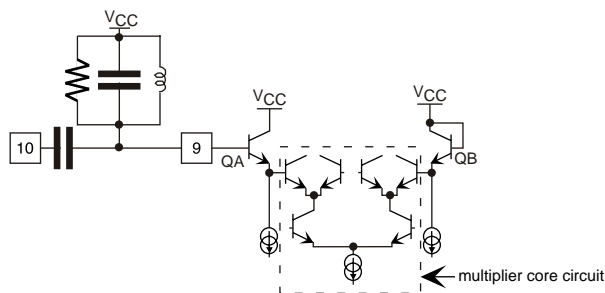

FIGURE 4

## CIRCUIT DESCRIPTION (CONT.)

The signal from the phase shifter is applied to the multiplier (in the dotted line) through emitter-follower stage QA. When the phase shifter is connected between Pin 10 and Pin 9, note that the bias voltage to Pin 9 should be provided from an external source because Pin 9 is only connected to the base of QA.

Because the base of QB (at the opposite side) is connected with the supply voltage, Pin 9 has to be biased with the equivalent voltage.

Using an LC resonance circuit is not a problem (see Figure 5). However, when using a ceramic discriminator, it is necessary to pay attention to bias. If there is a difference of the base voltages, the DC voltages of the multiplier do not balance. It alters the DC zero point or worsens the distortion of demodulation output.

The Pin 9 input level should be saturated at the multiplier; if this level is lower, it is easy to disperse the modulation output. Therefore, to have stable operation, Pin 9 should be higher than  $100\text{ mV}_{\text{P-P}}$ .

The following figures show examples of the phase shifter.

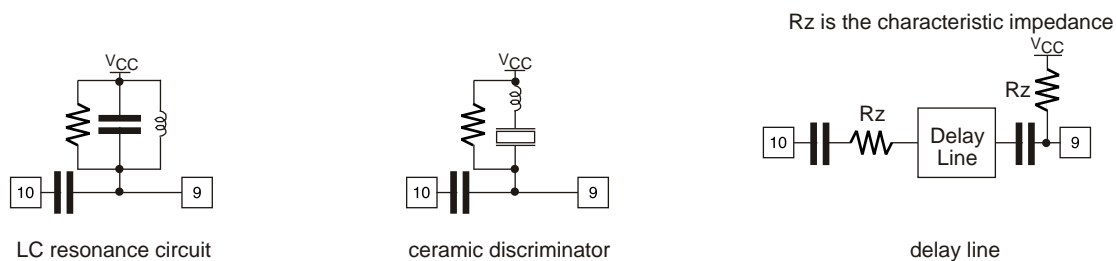

**FIGURE 5 - EXAMPLES OF PHASE SHIFTERS**

### Establishing Demodulation Characteristics:

Generally, demodulation characteristics of FM detectors are determined by the external phase shifter. However, this product has a unique function which can optionally establish the demodulation characteristics by the time constant of the circuit parts after demodulation. The following explains this concept.

Figure 6 shows the internal equivalent circuit of the detector output stage.

The multiplier output current of the detector is converted to a voltage by the internal OP AMP. The characteristic of this stage is determined by converting the current to voltage with resistor  $R_o$  and the capacitor  $C_o$  connected between Pin 7 and Pin 8 (see Figure 6).

In other words, the slope of the S-curve characteristic can be established optionally with resistor  $R_o$  without changing the constant of the phase shifter. The demodulated bandwidth can be established optionally by the time constant of this external resistor  $R_o$  and capacitor  $C_o$  inside of a bandwidth of the IF-filter and phase shifter. Figure 7 shows an example of this characteristic.



## CIRCUIT DESCRIPTION (CONT.)

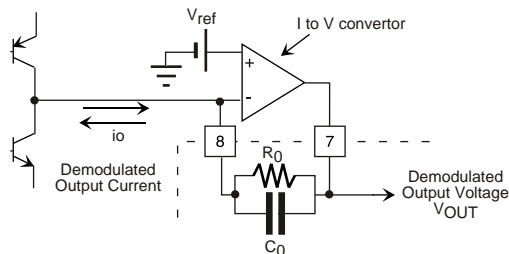

The -3 dB frequency  $F_c$  is calculated by the following:

$$F_c = \frac{1}{2 \pi C_0 R_0}$$

The S-curve output voltage is calculated by the following as centering around the internal reference voltage  $V_{ref}$ :

$$V_{OUT} = V_{ref} \pm i_o \times R_0$$

Where  $V_{ref} = 1.4$  V, maximum of current  $i_o = \pm 100$   $\mu$ A

**FIGURE 6 - INTERNAL EQUIVALENT CIRCUIT OF DETECTOR OUTPUT STAGE**

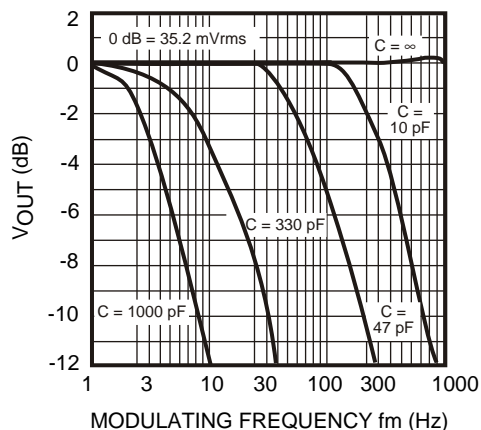

Operating Condition:

Measured by the standard test circuit.  
 Parallel resistor to phase shift coil = 1 k $\Omega$ .  
 $f_{IN} = 10.7$  MHz, modulation =  $\pm 100$  kHz.  
 External capacitance  $C_0 = 0 \sim 1000$  pF.

**FIGURE 7 - EXAMPLE: BANDWIDTH OF DEMODULATION VS. TIME CONSTANT CHARACTERISTIC**

### Center Voltage of Detector DC Output:

The center voltage of the detector DC output is determined by the internal reference voltage source. It is impossible to change this internal reference voltage source, but it is possible to change the center voltage by the following method.

As illustrated in Figure 8, the demodulated output current at Pin 8 is converted to the voltage by an external resistor R1 without using the internal OP AMP.

Figure 9 shows an example of a simple circuit that divides the supply voltage into halves using resistors. Since both circuits have a high output impedance, an external buffer amplifier should be connected.

**CIRCUIT DESCRIPTION (CONT.)**

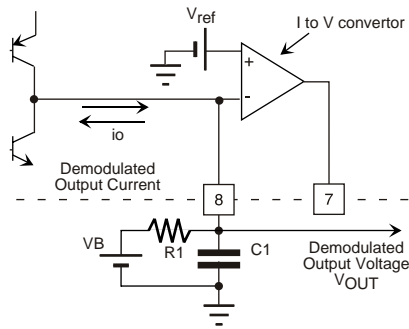

Demodulated Output Voltage  $V_{OUT} = V_B \pm R1 \times i_o$

Demodulated Bandwidth

$$F_c = \frac{1}{2 \pi C1(1/gm)}$$

1/gm is approximately 50 kΩ which is the output resistance of the multiplier.

Pin 7 is disconnected.

**FIGURE 8 - EXAMPLE OF USING EXTERNAL REFERENCE SOURCE**

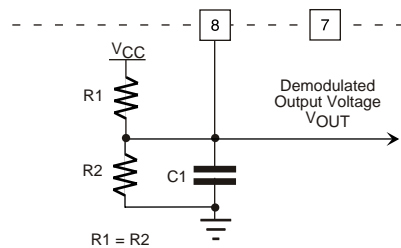

Demodulated Output Voltage  $V_{OUT} = V_{CC}/2 \pm R1 \times i_o$

Demodulated Bandwidth

$$F_c = \frac{1}{2 \pi C1(1/gm)}$$

1/gm is approximately 50 kΩ which is the output resistance of the multiplier.

Pin 7 is disconnected.

**FIGURE 9 - EXAMPLE OF DIVIDING SUPPLY VOLTAGE INTO HALVES BY THE RESISTORS**

**Power Save Function:**

Pin 5 is the control terminal for the battery save function. The ON/OFF operation of the whole IC can be switched by controlling the DC voltage at this terminal. Figure 10 shows the internal equivalent circuit of Pin 5.

Because it switches the bias circuit of the entire IC by using the transistor in standby mode, it reduces the supply current to near zero. As the input terminal is connected with an electrostatic discharge protection diode at GND side only, it is possible to control the voltage above the supply voltage. It is possible to go into standby mode by disconnecting Pin 5, but it is not recommended because Pin 5 is a high impedance and may malfunction by an external disturbance.

When Pin 5 is disconnected, a suitable capacitor should be connected between Pin 5 and GND.

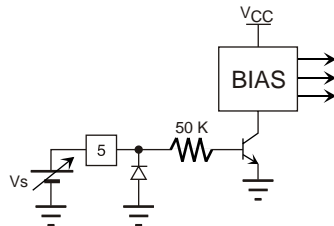
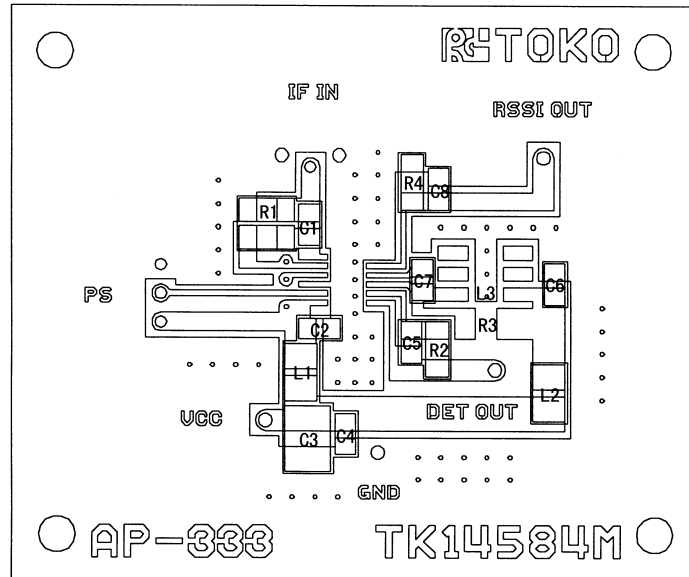

**FIGURE 10**

## TEST BOARD

TK14584M Test Board

(THE SURFACE)



(THE REVERSE)

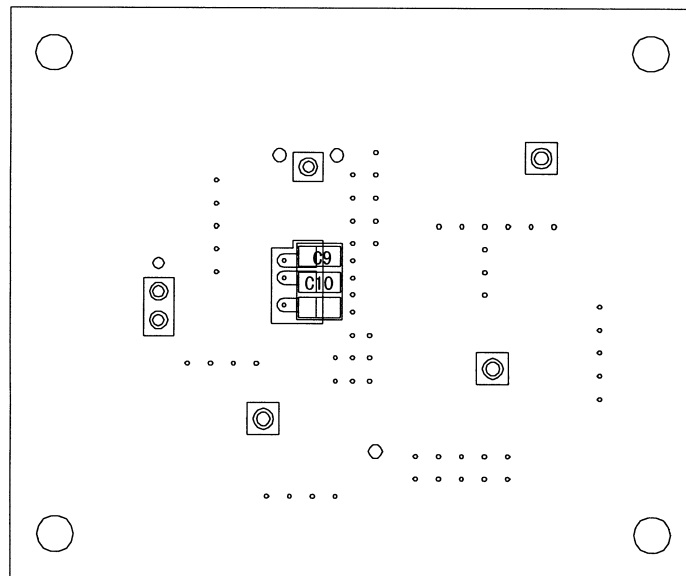

$C1 = C2 = C4 = C6 = C8 = C9 = C10 = 0.01 \mu\text{F}$   
 $C3 = 4.7 \mu\text{F}$ ,  $C5 = 1000 \text{ pF}$ ,  $C7 = 1 \text{ pF}$   
 $R1 = 51 \Omega$ ,  $R2 = 51 \text{ k}\Omega$ ,  $R3 = 3.3 \text{ k}\Omega$ ,  $R4 = 12 \text{ k}\Omega$ ,  $R5 = 3 \text{ k}\Omega$   
 $L1 = L2 = 10 \mu\text{H}$   
 $L3 = 836\text{BH-0268 (TOKO)}$

PACKAGE OUTLINE

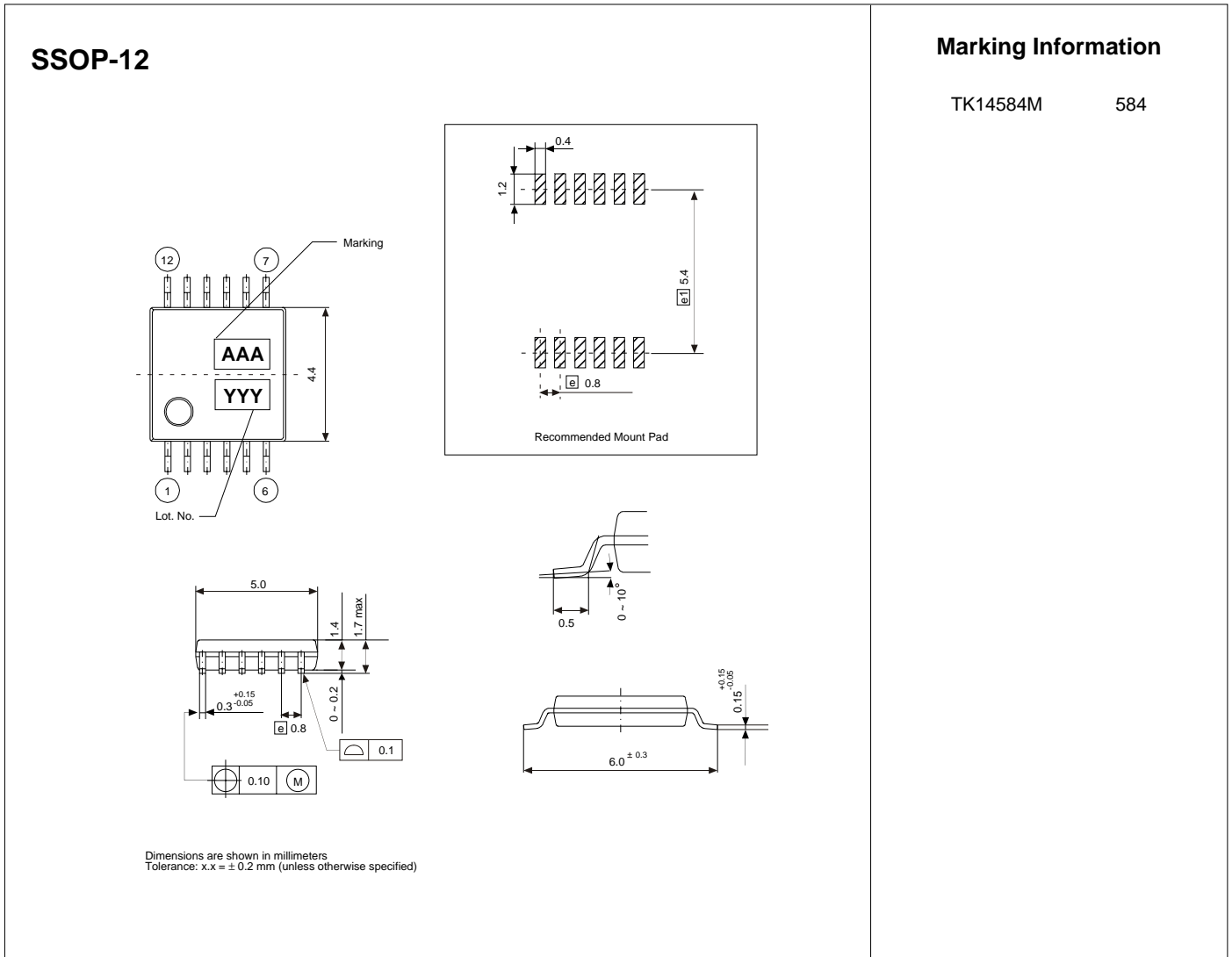

Toko America, Inc. Headquarters  
1250 Feehanville Drive, Mount Prospect, Illinois 60056  
Tel: (847) 297-0070 Fax: (847) 699-7864

TOKO AMERICA REGIONAL OFFICES

Midwest Regional Office  
Toko America, Inc.  
1250 Feehanville Drive  
Mount Prospect, IL 60056  
Tel: (847) 297-0070  
Fax: (847) 699-7864

Western Regional Office  
Toko America, Inc.  
2480 North First Street, Suite 260  
San Jose, CA 95131  
Tel: (408) 432-8281  
Fax: (408) 943-9790

Eastern Regional Office  
Toko America, Inc.  
107 Mill Plain Road  
Danbury, CT 06811  
Tel: (203) 748-6871  
Fax: (203) 797-1223

Semiconductor Technical Support  
Toko Design Center  
4755 Forge Road  
Colorado Springs, CO 80907  
Tel: (719) 528-2200  
Fax: (719) 528-2375

Visit our Internet site at <http://www.tokoam.com>

The information furnished by TOKO, Inc. is believed to be accurate and reliable. However, TOKO reserves the right to make changes or improvements in the design, specification or manufacture of its products without further notice. TOKO does not assume any liability arising from the application or use of any product or circuit described herein, nor for any infringements of patents or other rights of third parties which may result from the use of its products. No license is granted by implication or otherwise under any patent or patent rights of TOKO, Inc.