

PLEASE CHECK WWW.MOLEX.COM FOR LATEST PART INFORMATION

Part Number: [0878334219](#)
Status: **Active**
Overview: milligrid
Description: 2.00mm (.079") Pitch Milli-Grid™ Header, Right Angle, Fully Shrouded, Lead-free, 42 Circuits, Gold (Au) Flash Plating, without PCB Locator, without Locking Window, Center Polarization Slot, Tube

Documents:

[3D Model](#) [Product Specification PS-87831-027 \(PDF\)](#)
[Drawing \(PDF\)](#) [RoHS Certificate of Compliance \(PDF\)](#)

General

Product Family	PCB Headers
Series	87833
Application	Wire-to-Board
Comments	Contact Molex for application in automotive industry
Overview	milligrid
Product Name	Milli-Grid™

Physical

Breakaway	No
Circuits (Loaded)	42
Circuits (maximum)	42
Color - Resin	Black
Durability (mating cycles max)	100
First Mate / Last Break	No
Glow-Wire Compliant	No
Guide to Mating Part	No
Keying to Mating Part	None
Lock to Mating Part	None
Material - Metal	Phosphor Bronze
Material - Plating Mating	Gold
Material - Plating Termination	Tin
Material - Resin	Nylon
Number of Rows	2
Orientation	Right Angle
PC Tail Length (in)	0.085 In
PC Tail Length (mm)	2.16 mm
PCB Locator	No
PCB Retention	None
PCB Thickness Recommended (in)	0.062 In
PCB Thickness Recommended (mm)	1.60 mm
Packaging Type	Tube
Pitch - Mating Interface (in)	0.079 In
Pitch - Mating Interface (mm)	2.00 mm
Pitch - Term. Interface (in)	0.079 In
Pitch - Term. Interface (mm)	2.00 mm
Plating min: Mating (µin)	2
Plating min: Mating (µm)	0.05
Plating min: Termination (µin)	75
Plating min: Termination (µm)	1.88
Polarized to Mating Part	Side Slots (2)
Polarized to PCB	No
Shrouded	Fully
Stackable	No
Surface Mount Compatible (SMC)	Yes

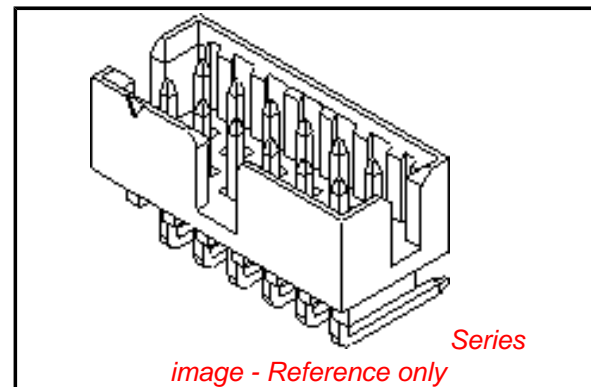

image - Reference only

EU RoHS

ELV and RoHS Compliant
REACH SVHC Contains SVHC: No
Halogen-Free Status

China RoHS



Not Reviewed

Need more information on product environmental compliance?

Email productcompliance@molex.com
 For a multiple part number RoHS Certificate of Compliance, [click here](#)

Please visit the [Contact Us](#) section for any non-product compliance questions.

Search Parts in this Series

[87833Series](#)

Mates With

[50394](#) Wire-to-Board Terminals. [51110](#) Wire-to-Board Crimp Housing. [87568](#) Wire-to-Board IDT Housings. [79107](#) Board-to-Board Top Entry Through Hole Receptacle. [79108](#) Board-to-Board FFC/FPC Top Entry Through Hole Receptacle. L

Temperature Range - Operating -55°C to +105°C
Termination Interface: Style Through Hole

Electrical

Current - Maximum per Contact 2A
Voltage - Maximum 125V

Material Info

Reference - Drawing Numbers

Product Specification PS-87831-027

This document was generated on 05/25/2010

PLEASE CHECK WWW.MOLEX.COM FOR LATEST PART INFORMATION

10 9 8 7 6 5 4 3 2 1

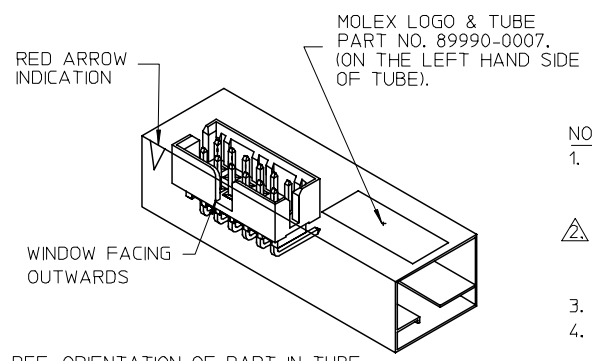
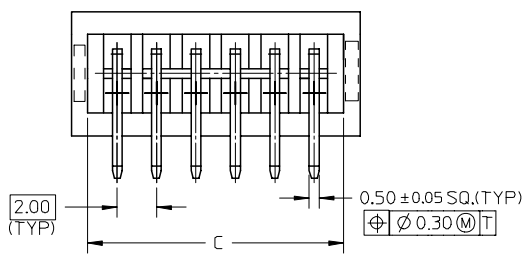
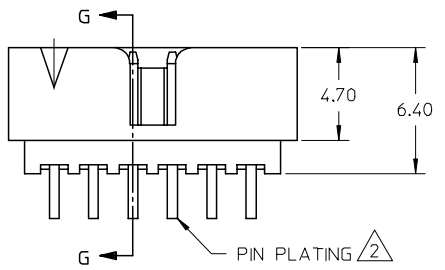
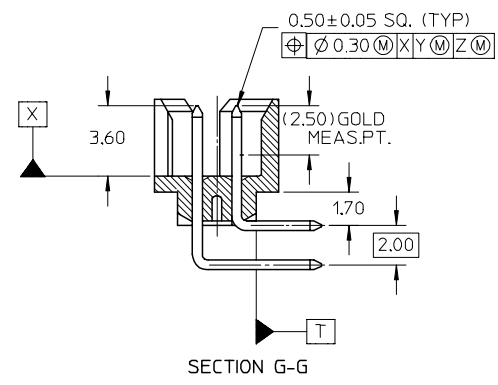
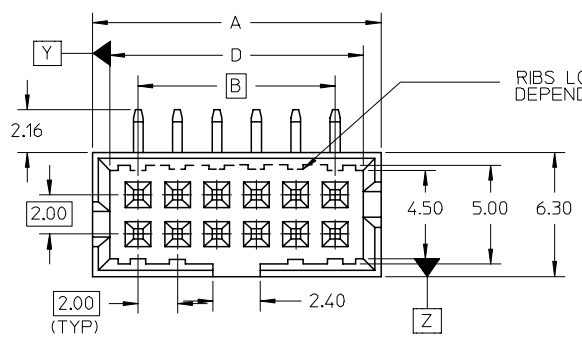

PART NO.	CKT SIZE	DIMENSION			
		A	B	C	D
87833-0419	4	6.65	2.00	5.00	4.85
87833-0619	6	8.65	4.00	7.00	6.85
87833-0819	8	10.65	6.00	9.00	8.85
87833-1019	10	12.65	8.00	11.00	10.85
87833-1219	12	14.65	10.00	13.00	12.85
87833-1419	14	16.65	12.00	15.00	14.85
87833-1619	16	18.65	14.00	17.00	16.85
87833-1819	18	20.65	16.00	19.00	18.85
87833-2019	20	22.65	18.00	21.00	20.85
87833-2219	22	24.65	20.00	23.00	22.85
87833-2419	24	26.65	22.00	25.00	24.85
87833-2619	26	28.65	24.00	27.00	26.85
87833-2819	28	30.65	26.00	29.00	28.85
87833-3019	30	32.65	28.00	31.00	30.85
87833-3219	32	34.65	30.00	33.00	32.85
87833-3419	34	36.65	32.00	35.00	34.85
87833-3619	36	38.65	34.00	37.00	36.85
87833-3819	38	40.65	36.00	39.00	38.85
87833-4019	40	42.65	38.00	41.00	40.85
87833-4219	42	44.65	40.00	43.00	42.85
87833-4419	44	46.65	42.00	45.00	44.85
87833-4619	46	48.65	44.00	47.00	46.85
87833-4819	48	50.65	46.00	49.00	48.85
87833-5019	50	52.65	48.00	51.00	50.85

NOTES:

- MATERIAL :
HOUSING : 30% G.F., NYLON 46, UL94V-0. COLOR BLACK.
PIN : 0.50MM SQ. PHOSPHOR BRONZE.
- PLATING :
(2 - 5)um/ (0.05 - 0.13)uin GOLD IN CONTACT AREA AND 1.88um/75uin MIN. TIN IN SOLDER TAIL AREA OVER 1.25um/50uin MIN. NICKEL OVERALL.
- PRODUCT SPECIFICATION PS-87831-027 APPLIES.
- THIS HEADER MATES WITH MOLEX:
a) CRIMP RECEPTACLE HOUSING, 51110 SERIES WITH CRIMP TERMINAL, 50394 SERIES.
b) 2MM MILLIGRID DUAL ROW IDT, 87568 SERIES.
- PARTS TO BE PACKED IN TUBE WITH MOISTURE BARRIER BAG

REF: ORIENTATION OF PART IN TUBE.
(FOR THE REFERENCE OF PART/TUBE ASSEMBLY.)

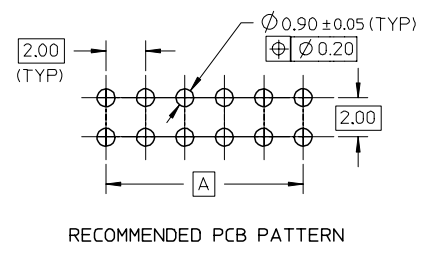

ADD MOIST BAG NOTE EC NO: S2007-0931 DRWN: GVENARLY CHKD: SXANG APPR: MLONG	QUALITY SYMBOLS ▽=0 ▽C=0	GENERAL TOLERANCES (UNLESS SPECIFIED)		DIMENSION STYLE MM ONLY		SCALE NTS	DESIGN UNITS METRIC	THIRD ANGLE PROJECTION			
		4 PLACES ± --- ± --- 3 PLACES ± --- ± --- 2 PLACES ± 0.2 ± --- 1 PLACE ± --- ± ---	mm INCH	DRAWN BY ATSEE	DATE 2003/10/27	TITLE MGRID, SHROUDED HEADER WITH SLOTS AND STANDOFF R/A					
		ANGULAR ± 3 °		CHECKED BY KCLING	DATE 2003/11/07	MOLEX MOLEX INCORPORATED					
		DRAFT WHERE APPLICABLE MUST REMAIN WITHIN DIMENSIONS		APPROVED BY SKTOH	DATE 2003/11/07	MATERIAL NO. SEE TABLE		DOCUMENT NO. SD-87833-013	SHEET NO. 1 OF 1		

9 8 7 6 5 4 3 2 1