

HFA08TA60CS

HEXFRED™

Ultrafast, Soft Recovery Diode

Features

- Ultrafast Recovery
- Ultrasoft Recovery
- Very Low I_{RRM}
- Very Low Q_{rr}
- Specified at Operating Conditions

Benefits

- Reduced RFI and EMI
- Reduced Power Loss in Diode and Switching Transistor
- Higher Frequency Operation
- Reduced Snubbing
- Reduced Parts Count

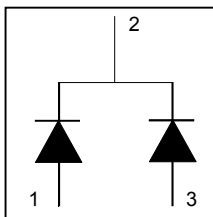

$$V_R = 600V$$

$$V_F = 1.8V$$

$$Q_{rr}^* = 40nC$$

$$di_{(rec)}/dt^* = 280A/\mu s$$

* 125°C

Description

International Rectifier's HFA08TA60CS is a state of the art center tap ultra fast recovery diode. Employing the latest in epitaxial construction and advanced processing techniques it features a superb combination of characteristics which result in performance which is unsurpassed by any rectifier previously available. With basic ratings of 600 volts and 4 amps per Leg continuous current, the HFA08TA60CS is especially well suited for use as the companion diode for IGBTs and MOSFETs. In addition to ultra fast recovery time, the HEXFRED product line features extremely low values of peak recovery current (I_{RRM}) and does not exhibit any tendency to "snap-off" during the t_b portion of recovery. The HEXFRED features combine to offer designers a rectifier with lower noise and significantly lower switching losses in both the diode and the switching transistor. These HEXFRED advantages can help to significantly reduce snubbing, component count and heatsink sizes. The HEXFRED HFA08TA60CS is ideally suited for applications in power supplies and power conversion systems (such as inverters), motor drives, and many other similar applications where high speed, high efficiency is needed.



D²Pak

Absolute Maximum Ratings

	Parameter	Max	Units
V_R	Cathode-to-Anode Voltage	600	V
$I_F @ T_C = 100^\circ C$	Continuous Forward Current	4.0	A
I_{FSM}	Single Pulse Forward Current	25	
I_{FRM}	Maximum Repetitive Forward Current	16	W
$P_D @ T_C = 25^\circ C$	Maximum Power Dissipation	25	
$P_D @ T_C = 100^\circ C$	Maximum Power Dissipation	10	C
T_J	Operating Junction and	-55 to +150	
T_{STG}	Storage Temperature Range		

Electrical Characteristics @ T_J = 25°C (unless otherwise specified)

	Parameter	Min	Typ	Max	Units	Test Conditions
V _{BR}	Cathode Anode Breakdown Voltage	600			V	I _R = 100μA
V _{FM}	Max Forward Voltage		1.5	1.8	V	I _F = 4.0A
			1.8	2.2		I _F = 8.0A See Fig. 1
			1.4	1.7		I _F = 4.0A, T _J = 125°C
I _{RM}	Max Reverse Leakage Current		0.17	3.0	μA	V _R = V _R Rated See Fig. 2
			44	300		T _J = 125°C, V _R = 0.8 x V _R Rated
C _T	Junction Capacitance		4.0	8.0	pF	V _R = 200V See Fig. 3
L _S	Series Inductance		8.0		nH	Measured lead to lead 5mm from package body

Dynamic Recovery Characteristics @ T_J = 25°C (unless otherwise specified)

	Parameter	Min	Typ	Max	Units	Test Conditions	
t _{rr}	Reverse Recovery Time		17		ns	I _F = 1.0A, di/dt = 200A/μs, V _R = 30V T _J = 25°C	
t _{rr1}	See Fig. 5, 6 & 16		28	42			T _J = 125°C
t _{rr2}			38	57			I _F = 4.0A
I _{RRM1}	Peak Recovery Current		2.9	5.2		V _R = 200V	
I _{RRM2}	See Fig. 7 & 8		3.7	6.7			T _J = 125°C
Q _{rr1}	Reverse Recovery Charge		40	60		di/dt = 200A/μs	
Q _{rr2}	See Fig. 9 & 10		70	105	T _J = 25°C		
dI _{(rec)M} /dt1	Peak Rate of Fall of Recovery Current		280		T _J = 25°C		
dI _{(rec)M} /dt2	During t _b See Fig. 11 & 12		235		T _J = 125°C		

Thermal - Mechanical Characteristics

	Parameter	Min	Typ	Max	Units
T _{lead} ①	Lead Temperature			300	°C
R _{thJC}	Thermal Resistance, Junction to Case			5.0	K/W
R _{thJA} ②	Thermal Resistance, Junction to Ambient			80	
Wt	Weight		2.0		g
			0.07		(oz)
T	Mounting Torque		6.0	12	Kg-cm
			5.0	10	lbf·in

① 0.063 in. from Case (1.6mm) for 10 sec

② Typical Socket Mount

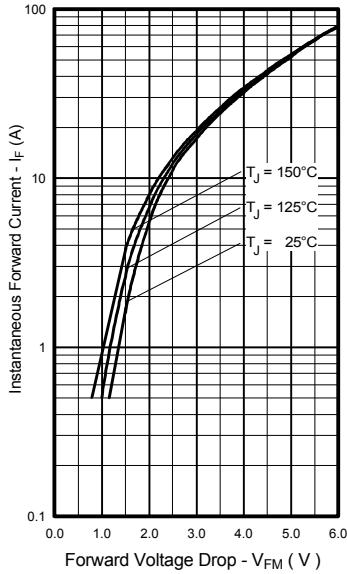

Fig. 1 - Maximum Forward Voltage Drop vs. Instantaneous Forward Current,

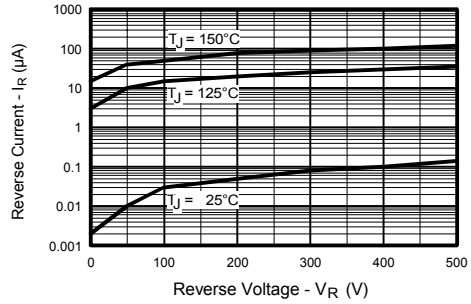

Fig. 2 - Typical Reverse Current vs. Reverse Voltage

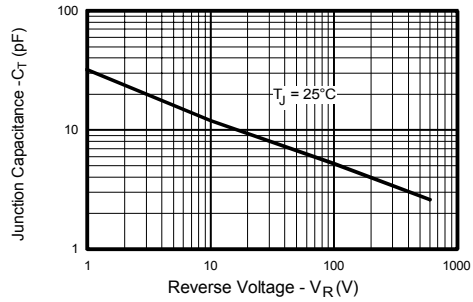

Fig. 3 - Typical Junction Capacitance vs. Reverse Voltage

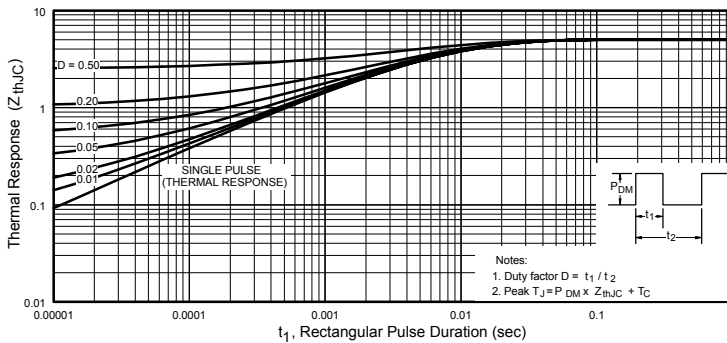

Fig. 4 - Maximum Thermal Impedance Z_{thjC} Characteristics

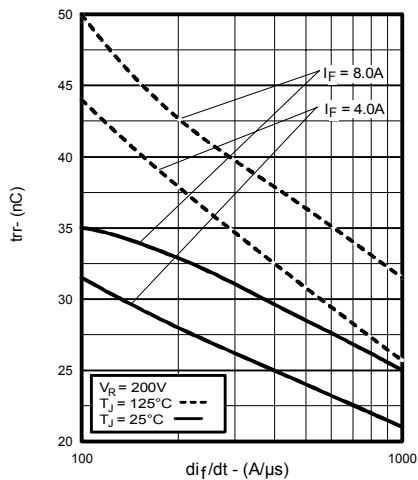

Fig. 5 - Typical Reverse Recovery vs. di_f/dt

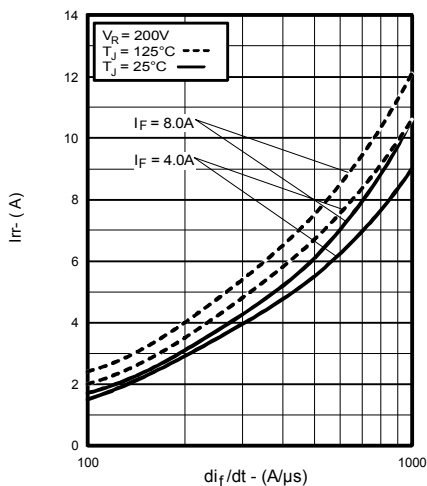

Fig. 6 - Typical Recovery Current vs. di_f/dt

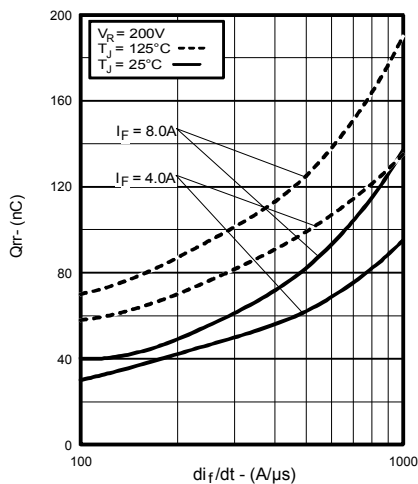

Fig. 7 - Typical Stored Charge vs. di_f/dt

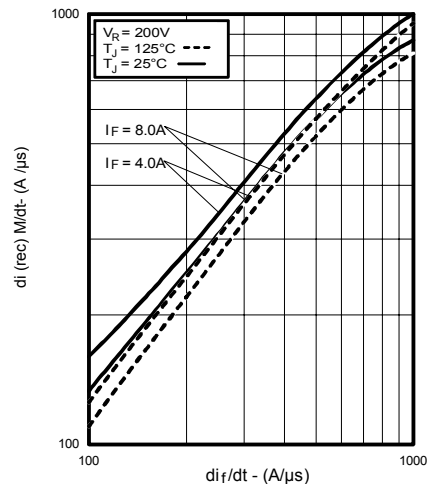

Fig. 8 - Typical $di_{(rec)M}/dt$ vs. di_f/dt

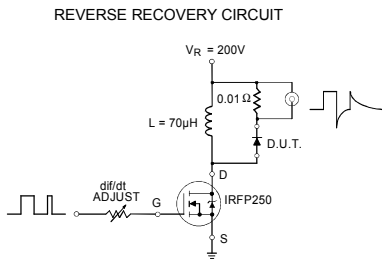

Fig. 9 - Reverse Recovery Parameter Test Circuit

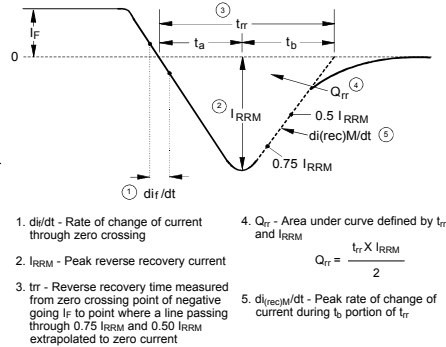
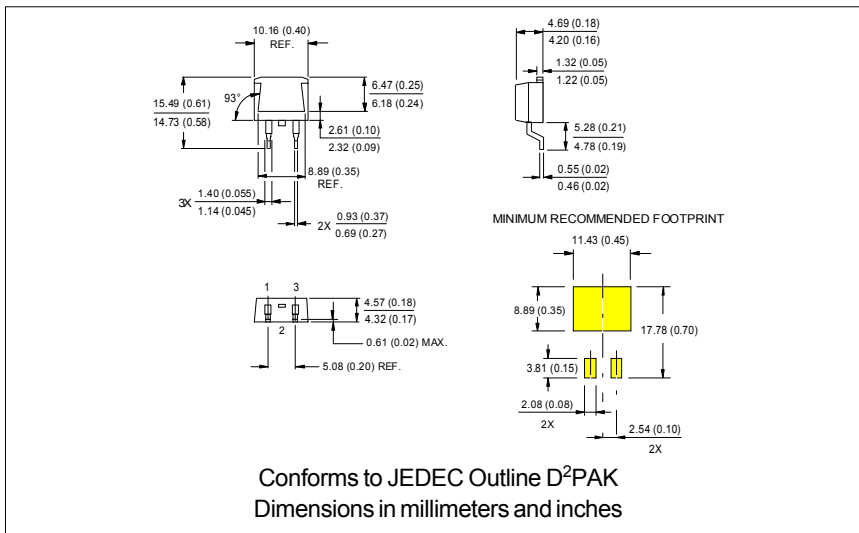

Fig. 10 - Reverse Recovery Waveform and Definitions

HFA08TA60CS

Bulletin PD-20058 01/01



IR WORLD HEADQUARTERS: 233 Kansas St., El Segundo, California 90245, USA Tel: (310) 252-7105

TAC Fax: (310) 252-7309

Visit us at www.irf.com for sales contact information. 01/01