

PLEASE CHECK WWW.MOLEX.COM FOR LATEST PART INFORMATION

Part Number: [0395430007](#)
Status: **Active**
Description: 5.00mm (.197") Pitch Eurostyle™ Vertical Fixed Mount PCB Terminal Block, with Screw Pressure Clamp, 7 Circuits

Documents:

[3D Model](#)
[Drawing \(PDF\)](#)

[RoHS Certificate of Compliance \(PDF\)](#)

General

| | |
|-----------------------------|-----------------------------|
| Product Family | Terminal Blocks |
| Series | 39543 |
| Application | Wire-to-Board |
| Component Type | One Piece |
| Product Literature Order No | USA-355 |
| Product Name | ESE, Eurostyle™ Fixed Mount |
| Type | Euro Block |

Physical

| | |
|--------------------------------|------------------------|
| Circuits (Loaded) | 7 |
| Entry Angle | Horizontal |
| Lock to Mating Part | None |
| Number of Rows | 1 |
| Orientation | Vertical |
| PC Tail Length (in) | 0.142 In |
| PC Tail Length (mm) | 3.60 mm |
| PCB Thickness Recommended (in) | 0.098 In |
| PCB Thickness Recommended (mm) | 2.50 mm |
| Panel Mount | No |
| Pitch - Mating Interface (in) | 0.197 In |
| Pitch - Mating Interface (mm) | 5.00 mm |
| Polarized to Mating Part | N/A |
| Stackable | No |
| Temperature Range - Operating | -40°C to +105°C |
| Wire Size AWG | 14, 16, 18, 20, 22, 24 |
| Wire Size mm² | 0.20 - 2.08 |

Electrical

| | |
|-------------------|------|
| Current - Maximum | 10A |
| Voltage - Maximum | 300V |

Solder Process Data

| | |
|--|------------------------|
| Duration at Max. Process Temperature (seconds) | 5 |
| Lead-free Process Capability | Wave Capable (TH only) |
| Max. Cycles at Max. Process Temperature | 135 |
| Process Temperature max. C | 260 |

Material Info

Reference - Drawing Numbers

Sales Drawing SD-39501-002, SD-39543-003

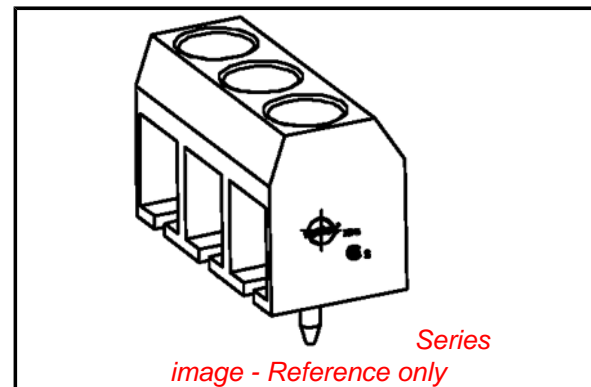

EU RoHS

ELV and RoHS Compliant
REACH SVHC
 Not Reviewed
Halogen-Free Status

China RoHS



Not Reviewed

Need more information on product environmental compliance?

Email productcompliance@molex.com
 For a multiple part number RoHS Certificate of Compliance, [click here](#)

Please visit the [Contact Us](#) section for any non-product compliance questions.

Search Parts in this Series

[39543Series](#)

3950X SERIES
3.50mm HEADERS

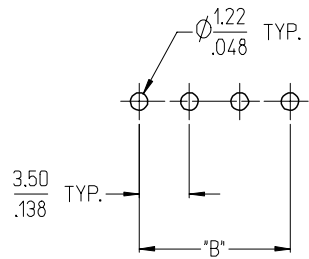

3952X & 3954X SERIES
5.00mm HEADERS
5.00mm 10 AMP FIXED

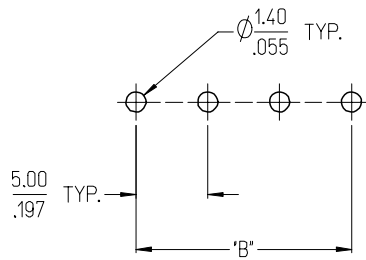

3953X SERIES
5.08mm HEADERS

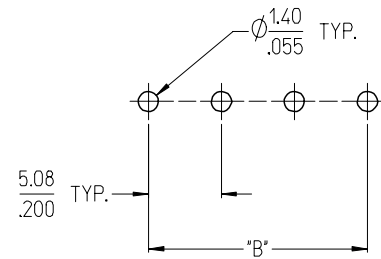

3951X SERIES
3.81mm HEADERS

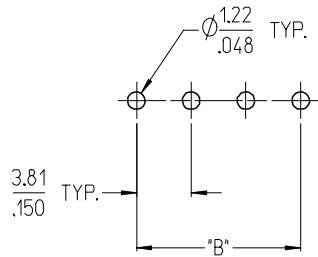

3954X SERIES
5.00mm 15 AMP FIXED

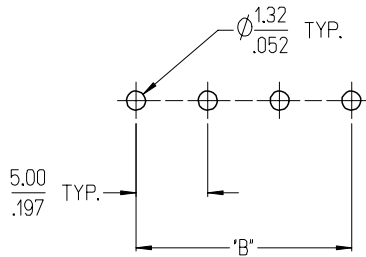

3954X SERIES
5.08mm 15 AMP FIXED

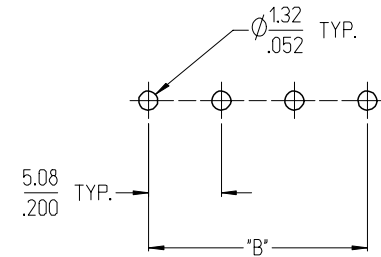

NOTES:

- REFER TO INDIVIDUAL PRODUCT SALES DRAWINGS FOR "B" DIMENSION.
- DOES NOT APPLY TO DUAL LEVEL HEADERS, SERIES 39528 AND 39538.
- TYP. = TYPICAL.

| | |
|-----------------|---------------------|
| INITIAL RELEASE | EC NO: ETC2007-0096 |
| DRWN: CLYORK | 2006/10/02 |
| CHKD: JMACNEIL | 2006/10/04 |
| APPR: JMACNEIL | 2006/10/04 |
| REV | DESCRIPTION |
| A | |

| |
|-----------------|
| QUALITY SYMBOLS |
| ◀=0 |
| ▽=0 |

| GENERAL TOLERANCES (UNLESS SPECIFIED) | |
|--|-----------------|
| | MM/INCH |
| 4 PLACES | ± .005 / ± .005 |
| 3 PLACES | ± .005 / ± .005 |
| 2 PLACES | ± 0.13 / ± .01 |
| 1 PLACE | ± 0.3 / ± .01 |
| ANGULAR ± 2 ° | |
| DRAFT WHERE APPLICABLE MUST REMAIN WITHIN DIMENSIONS | |

| DIMENSION STYLE | |
|-----------------|------------|
| MM/IN | |
| DRAWN BY | DATE |
| C. YORK | 2006/08/25 |
| CHECKED BY | DATE |
| J. MACNEIL | 2006/08/25 |
| APPROVED BY | DATE |
| J. MACNEIL | 2006/08/25 |
| MATERIAL NO. | |
| -- | |

| | | |
|--|--------------|------------------------|
| SCALE | DESIGN UNITS | THIRD ANGLE PROJECTION |
| 3:1 | INCH | |
| TITLE | | |
| RECOMMENDED PCB LAYOUT FOR ESE TERMINAL BLOCKS | | |
| MOLEX INCORPORATED | | |
| DOCUMENT NO. | SHEET NO. | |
| SD-39501-002 | 1 OF 1 | |
| SIZE B THIS DRAWING CONTAINS INFORMATION THAT IS PROPRIETARY TO MOLEX INCORPORATED AND SHOULD NOT BE USED WITHOUT WRITTEN PERMISSION | | |

10 9 8 7 6 5 4 3 2 1

F
E
D
C
B
A

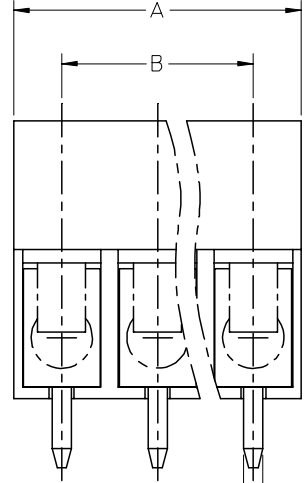
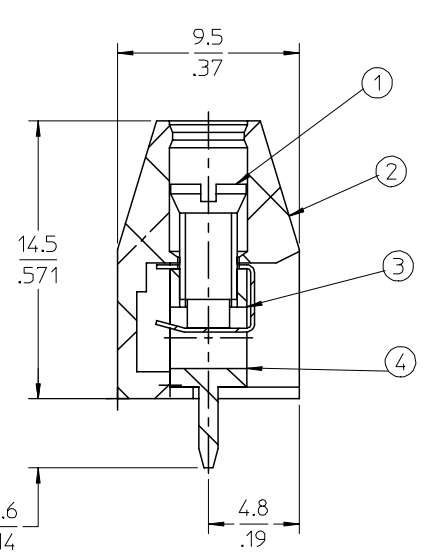
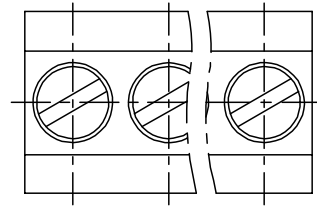
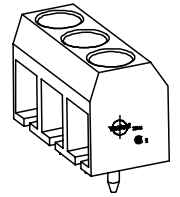

1.00
.039

SPECIFICATIONS:

1. Material:
 - (1). Screw: Steel.
 - (2). Body: PA66
 - (3). Wire Protector: QSn
 - (4). Terminal: Brass
2. Wire range: 24 - 14AWG.
3. Electrical rating: 300V, 10A.
4. MAX TORQUE: 3 in-lbs.
5. Wire strip length: 5.00mm.
6. Insulation resistance: DC500V, 500M.
7. Operating temperature: -40C to +105C.
8. A = N x P.
9. B = (N - 1) x P
10. P = (Pitch) = 5.00mm (.197").
11. N = Number of positions available 2 through 24.

| | | | | | | | | |
|---|-------------------------------|---|--------------|-----------------|---|--------------|------------------------|--|
| ENTER DESCRIPTION EC NO: NEO2006-0310 DRWNL: LROTHAUS 2006/01/09 CHKD: CYORK 2006/01/09 APPR: JPAWLICK 2006/01/10 | QUALITY SYMBOLS ▽=0 ▽=0 | GENERAL TOLERANCES (UNLESS SPECIFIED) | | DIMENSION STYLE | SCALE | DESIGN UNITS | THIRD ANGLE PROJECTION | |
| | | | | MM/IN | 4:1 | INCH | | |
| | | 4 PLACES ± --- ±.0015 | DRAWN BY | DATE | TITLE | | | |
| | | 3 PLACES ±0.038 ±.005 | LROTHAUS | 12/6/05 | 5.0MM, EURO TERM. BLOCK PC MOUNT, VERTICAL | | | |
| 2 PLACES ±0.13 ±.01 | CHECKED BY | DATE | APPROVED BY | | | | | |
| 1 PLACE ±0.3 ±--- | C. YORK | 01/06/06 | DATE | | | | | |
| ANGULAR ± 2 ° | MATERIAL NO. | | DOCUMENT NO. | | SHEET NO. | | | |
| DRAFT WHERE APPLICABLE MUST REMAIN WITHIN DIMENSIONS | SEE CHART | | SD-39543-003 | | 1 OF 1 | | | |
| | SIZE | THIS DRAWING CONTAINS INFORMATION THAT IS PROPRIETARY TO MOLEX INCORPORATED AND SHOULD NOT BE USED WITHOUT WRITTEN PERMISSION | | | | | | |
| | B | | | | | | | |

9 8 7 6 5 4 3 2 1

| Description | Circuit size | Material Numbers | | | | | | Dimensional Information | | | |
|---------------------------------------|--------------|------------------|-----------|-----------|------------------|-----------|-----------|-------------------------|-------|--------|-------|
| | | Black | | | Green | | | | | | |
| | | 100% Tin | | | 100% Tin | | | | | | |
| | | Printing Options | | | Printing Options | | | Dim. A | | Dim B | |
| None | 10A | 11A | None | 10A | 11A | mm | inch | mm | inch | | |
| 5.0mm, Euro Block, PC Mount, Vertical | 2 | 395430002 | 395431002 | 395432002 | 395930002 | 395931002 | 395932002 | 10.00 | 0.394 | 5.00 | 0.197 |
| 5.0mm, Euro Block, PC Mount, Vertical | 3 | 395430003 | 395431003 | 395432003 | 395930003 | 395931003 | 395932003 | 15.00 | 0.591 | 10.00 | 0.394 |
| 5.0mm, Euro Block, PC Mount, Vertical | 4 | 395430004 | 395431004 | 395432004 | 395930004 | 395931004 | 395932004 | 20.00 | 0.787 | 15.00 | 0.591 |
| 5.0mm, Euro Block, PC Mount, Vertical | 5 | 395430005 | 395431005 | 395432005 | 395930005 | 395931005 | 395932005 | 25.00 | 0.984 | 20.00 | 0.787 |
| 5.0mm, Euro Block, PC Mount, Vertical | 6 | 395430006 | 395431006 | 395432006 | 395930006 | 395931006 | 395932006 | 30.00 | 1.181 | 25.00 | 0.984 |
| 5.0mm, Euro Block, PC Mount, Vertical | 7 | 395430007 | 395431007 | 395432007 | 395930007 | 395931007 | 395932007 | 35.00 | 1.378 | 30.00 | 1.181 |
| 5.0mm, Euro Block, PC Mount, Vertical | 8 | 395430008 | 395431008 | 395432008 | 395930008 | 395931008 | 395932008 | 40.00 | 1.575 | 35.00 | 1.378 |
| 5.0mm, Euro Block, PC Mount, Vertical | 9 | 395430009 | 395431009 | 395432009 | 395930009 | 395931009 | 395932009 | 45.00 | 1.772 | 40.00 | 1.575 |
| 5.0mm, Euro Block, PC Mount, Vertical | 10 | 395430010 | 395431010 | 395432010 | 395930010 | 395931010 | 395932010 | 50.00 | 1.969 | 45.00 | 1.772 |
| 5.0mm, Euro Block, PC Mount, Vertical | 11 | 395430011 | 395431011 | 395432011 | 395930011 | 395931011 | 395932011 | 55.00 | 2.165 | 50.00 | 1.969 |
| 5.0mm, Euro Block, PC Mount, Vertical | 12 | 395430012 | 395431012 | 395432012 | 395930012 | 395931012 | 395932012 | 60.00 | 2.362 | 55.00 | 2.165 |
| 5.0mm, Euro Block, PC Mount, Vertical | 13 | 395430013 | 395431013 | 395432013 | 395930013 | 395931013 | 395932013 | 65.00 | 2.559 | 60.00 | 2.362 |
| 5.0mm, Euro Block, PC Mount, Vertical | 14 | 395430014 | 395431014 | 395432014 | 395930014 | 395931014 | 395932014 | 70.00 | 2.756 | 65.00 | 2.559 |
| 5.0mm, Euro Block, PC Mount, Vertical | 15 | 395430015 | 395431015 | 395432015 | 395930015 | 395931015 | 395932015 | 75.00 | 2.953 | 70.00 | 2.756 |
| 5.0mm, Euro Block, PC Mount, Vertical | 16 | 395430016 | 395431016 | 395432016 | 395930016 | 395931016 | 395932016 | 80.00 | 3.150 | 75.00 | 2.953 |
| 5.0mm, Euro Block, PC Mount, Vertical | 17 | 395430017 | 395431017 | 395432017 | 395930017 | 395931017 | 395932017 | 85.00 | 3.346 | 80.00 | 3.150 |
| 5.0mm, Euro Block, PC Mount, Vertical | 18 | 395430018 | 395431018 | 395432018 | 395930018 | 395931018 | 395932018 | 90.00 | 3.543 | 85.00 | 3.346 |
| 5.0mm, Euro Block, PC Mount, Vertical | 19 | 395430019 | 395431019 | 395432019 | 395930019 | 395931019 | 395932019 | 95.00 | 3.740 | 90.00 | 3.543 |
| 5.0mm, Euro Block, PC Mount, Vertical | 20 | 395430020 | 395431020 | 395432020 | 395930020 | 395931020 | 395932020 | 100.00 | 3.937 | 95.00 | 3.740 |
| 5.0mm, Euro Block, PC Mount, Vertical | 21 | 395430021 | 395431021 | 395432021 | 395930021 | 395931021 | 395932021 | 105.00 | 4.134 | 100.00 | 3.937 |
| 5.0mm, Euro Block, PC Mount, Vertical | 22 | 395430022 | 395431022 | 395432022 | 395930022 | 395931022 | 395932022 | 110.00 | 4.331 | 105.00 | 4.134 |
| 5.0mm, Euro Block, PC Mount, Vertical | 23 | 395430023 | 395431023 | 395432023 | 395930023 | 395931023 | 395932023 | 115.00 | 4.528 | 110.00 | 4.331 |
| 5.0mm, Euro Block, PC Mount, Vertical | 24 | 395430024 | 395431024 | 395432024 | 395930024 | 395931024 | 395932024 | 120.00 | 4.724 | 115.00 | 4.528 |

| | | | | | | | | |
|---|-------------------------------|---|------------------------------|---|------|--------------------|----------------------|------------------------|
| SEE PAGE 1 EC NO: NEC2006-0310 DRWNL: LROTHAUS 2006/01/09 CHKD: CYORK 2006/01/09 APPR: J:AMLIK 2006/01/10 | QUALITY SYMBOLS ▽=0 ▽=0 | GENERAL TOLERANCES (UNLESS SPECIFIED) | | DIMENSION STYLE MM/IN | | SCALE 4:1 | DESIGN UNITS INCH | THIRD ANGLE PROJECTION |
| | | 4 PLACES ± --- ±.0015 3 PLACES ±0.038 ±.005 2 PLACES ±0.13 ±.01 1 PLACE ±0.3 ± --- | mm INCH DATE 12/6/05 | TITLE 5.0MM, EURO TERM. BLOCK PC MOUNT, VERTICAL | | | | |
| | | DRAFT WHERE APPLICABLE MUST REMAIN WITHIN DIMENSIONS | | APPROVED BY C. YORK | DATE | MOLEX INCORPORATED | | |
| | | MATERIAL NO. SEE CHART | DOCUMENT NO. SD-39543-003 | SHEET NO. 2 OF 2 | | | | |