

**PLEASE CHECK WWW.MOLEX.COM FOR LATEST PART INFORMATION**

**Part Number:** [0702476051](#)  
**Status:** **Active**  
**Overview:** [cgrid\\_sl\\_products](#)  
**Description:** 2.54mm (.100") Pitch C-Grid® Header, Dual Row, Low Profile, Right Angle, Shrouded, 60 Circuits, 0.38µm (15µ") Gold (Au) Selective Plating, Tin (Sn) PC Tail Plating

**Documents:**

[3D Model](#) [Product Specification PS-70246-100 \(PDF\)](#)  
[Drawing \(PDF\)](#) [RoHS Certificate of Compliance \(PDF\)](#)  
[Product Specification PS-70246 \(PDF\)](#)

**Agency Certification**

CSA LR19980  
 UL E29179

**General**

Product Family PCB Headers  
 Series [70247](#)  
 Application Wire-to-Board  
 Overview [cgrid\\_sl\\_products](#)  
 Product Name C-Grid®

**Physical**

Breakaway No  
 Circuits (Loaded) 60  
 Circuits (maximum) 60  
 Color - Resin Black  
 Durability (mating cycles max) 50  
 First Mate / Last Break No  
 Flammability 94V-0  
 Glow-Wire Compliant No  
 Guide to Mating Part No  
 Keying to Mating Part None  
 Lock to Mating Part None  
 Material - Plating Mating Gold  
 Material - Plating Termination Tin  
 Material - Resin Polyester  
 Number of Rows 2  
 Orientation Right Angle  
 PC Tail Length (in) 0.120 In  
 PC Tail Length (mm) 3.05 mm  
 PCB Locator No  
 PCB Retention None  
 PCB Thickness Recommended (in) 0.062 In  
 PCB Thickness Recommended (mm) 1.60 mm  
 Packaging Type Tray  
 Pitch - Mating Interface (in) 0.100 In  
 Pitch - Mating Interface (mm) 2.54 mm  
 Plating min: Mating (µin) 15.2  
 Plating min: Mating (µm) 0.38  
 Plating min: Termination (µin) 75.2  
 Plating min: Termination (µm) 1.88  
 Polarized to Mating Part Center Slot  
 Shrouded Fully  
 Stackable No  
 Temperature Range - Operating -55°C to +120°C

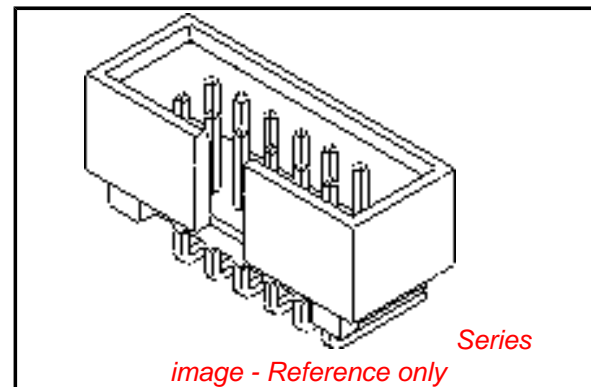

**EU RoHS**

**ELV and RoHS  
 Compliant**

**REACH SVHC**

**Contains SVHC: No**

**Halogen-Free**

**Status**

**Not Reviewed**

**China RoHS**



**Need more information on product  
 environmental compliance?**

Email [productcompliance@molex.com](mailto:productcompliance@molex.com)  
 For a multiple part number RoHS Certificate of  
 Compliance, [click here](#)

Please visit the [Contact Us](#) section for any  
 non-product compliance questions.

**Search Parts in this Series**

[70247Series](#)

**Mates With**

[70450 SL™](#) Crimp Housing, [70058 SL™](#)  
 Crimp Terminal

Termination Interface: Style Through Hole

### **Electrical**

Current - Maximum per Contact 2.5A  
Voltage - Maximum 250V DC

### **Solder Process Data**

Duration at Max. Process Temperature (seconds) 10  
Lead-free Process Capability Wave Capable (TH only)  
Max. Cycles at Max. Process Temperature 1  
Process Temperature max. C 265

### **Material Info**

### **Reference - Drawing Numbers**

Packaging Specification PK-87835-001  
Product Specification PS-70246, PS-70246-100  
Sales Drawing SDA-70247-\*\*-00-04

This document was generated on 05/24/2010

**PLEASE CHECK [WWW.MOLEX.COM](http://WWW.MOLEX.COM) FOR LATEST PART INFORMATION**

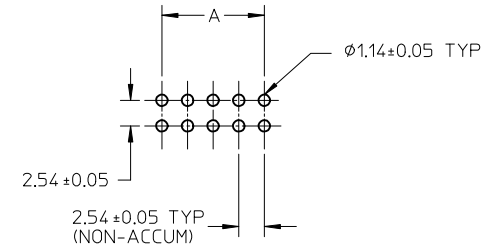
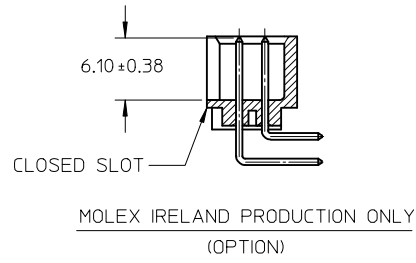
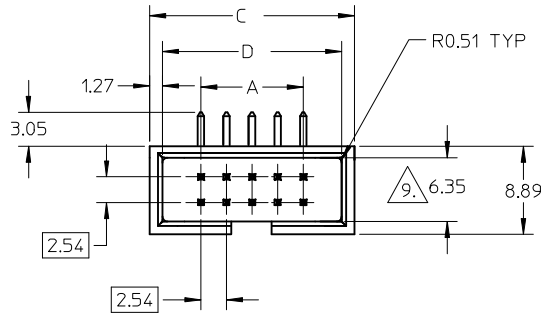

RECOMMENDED PCB HOLE LAYOUT

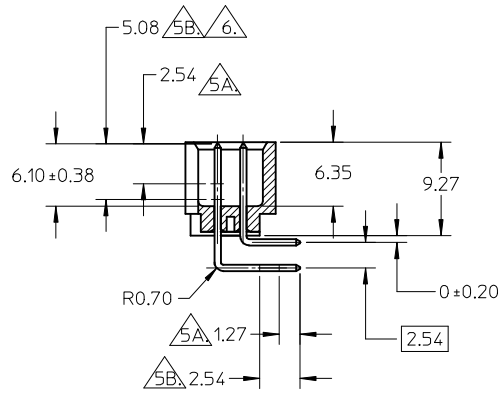
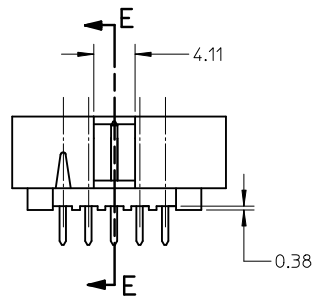

SECTION E-E

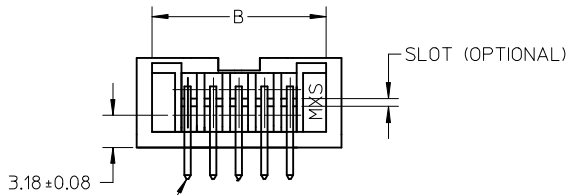

AT TIPS BOTH ENDS

LEGEND:



70247 - \* \* \* \*  
 CKT SIZE  
 PLATING OPT.



REVISE DIMENSIONS EC NO: S2010-0369 DRWN:SKANG 2009/10/27 CHKD:ATSEE 2009/11/09 APPR:MLONG 2009/11/11	QUALITY SYMBOLS $F_A=0$ $F_G=0$ $F_P=0$	GENERAL TOLERANCES (UNLESS SPECIFIED) mm INCH 4 PLACES ± --- ± --- 3 PLACES ± --- ± --- 2 PLACES ± 0.20 ± --- 1 PLACE ± --- ± --- ANGULAR ± 3 °	DIMENSION STYLE MM ONLY DRAWN BY JENNIFER DATE 1987/09/21 CHECKED BY MLAI DATE 1987/09/21 APPROVED BY MLONG DATE 2009/11/10	SCALE NTS DESIGN UNITS METRIC THIRD ANGLE PROJECTION	TITLE C-GRID, SHROUDED HEADER R/A (SLOTTED W/O STANDOFFS) MOLEX INCORPORATED	
	DRAFT WHERE APPLICABLE MUST REMAIN WITHIN DIMENSIONS	MATERIAL NO. SEE TABLE DOCUMENT NO. SDA-70247-**-00-04 SHEET NO. 1 OF 2	THIS DRAWING CONTAINS INFORMATION THAT IS PROPRIETARY TO MOLEX INCORPORATED AND SHOULD NOT BE USED WITHOUT WRITTEN PERMISSION			
	H3	REV	MOLEX IRELAND PRODUCTION ONLY (OPTION)			
	MOLEX INCORPORATED					

**NOTES:**



1. PIN PUSHOUT FORCE (.9072KG)/2LBS MIN.
2. PIN SOLDERABILITY PER MOLEX SPEC. ES-152.
3. PRODUCT SPEC: PS-70246 APPLIES.
4. WAFER TO BE FLAT WITHIN .003 MM/MM.
5. DIMENSIONS FOR PLATING LOCATION:

 MEASURE POINT FOR THICKNESS  
 MINIMUM COVERAGE

-  GOLD END OF PIN UNLESS OVERALL PLATED.
-  FINISH: - 51 : 15 MICRO INCHES MIN GOLD PLATE ON CONTACT AND 75 MICRO INCHES MIN TIN PLATE ON SOLDERTAIL BOTH OVER 50 MICRO INCHES MIN NICKEL OVERALL.  
 - 52 : 30 MICRO INCHES MIN GOLD PLATE ON CONTACT AND 75 MICRO INCHES MIN TIN PLATE ON SOLDERTAIL BOTH OVER 50 MICRO INCHES MIN NICKEL OVERALL.  
 - 54 : 5 MICRO INCHES MIN GOLD PLATE ON CONTACT AND 75 MICRO INCHES MIN TIN PLATE ON SOLDERTAIL BOTH OVER 50 MICRO INCHES MIN NICKEL OVERALL.

-  CHECK WITH SALES OFFICE FOR AVAILABILITY.
-  DIM AT THE CENTRE OF THE SHROUDED WALL SHALL BE 5.91MM MIN. THIS SPEC IS VALID FOR ALL CKT SIZE.
10. MATERIAL:  
 HSG: PBT, GLASS FILLED, UL94V-0, COLOUR: BLACK (SPEC NO: 89992-0028)  
 PIN: 0.64MM SQ. PIN PHOSPHOR BRONZE.
-  SOLDERTAIL POSITION TOLERANCE TO BE GAUGED.

PART NUMBER 	CKT SIZE	DIM A	DIM B	DIM C	DIM D
70247-08**	08	7.62	14.73	17.78	15.24
70247-10**	10	10.16	17.27	20.32	17.78
70247-12**	12	12.70	19.81	22.86	20.32
70247-14**	14	15.24	22.35	25.40	22.86
70247-16**	16	17.78	24.89	27.94	25.40
70247-20**	20	22.86	29.97	33.02	30.48
70247-24**	24	27.94	35.05	38.10	35.56
70247-26**	26	30.48	37.59	40.64	38.10
70247-30**	30	35.56	42.67	45.72	43.18
70247-34**	34	40.64	47.75	50.80	48.26
70247-40**	40	48.26	55.37	58.42	55.88
70247-44**	44	53.34	60.45	63.50	60.96
70247-48**	48	58.42	65.53	68.58	66.04
70247-50**	50	60.96	68.07	71.12	68.58
70247-56**	56	68.58	75.69	78.74	76.20
70247-60**	60	73.66	80.77	83.82	81.28
70247-64**	64	78.74	85.85	88.90	86.36
70247-72**	72	88.90	96.01	99.06	96.52

REVISE DIMENSIONS EC NO: S2010-0369 2009/10/27 DRWN:SKANG CHKD:ATSEE 2009/11/09 APPR:MLONG 2009/11/11	QUALITY SYMBOLS	GENERAL TOLERANCES (UNLESS SPECIFIED)		DIMENSION STYLE MM ONLY		SCALE NTS	DESIGN UNITS METRIC	THIRD ANGLE PROJECTION		
	 =0	4 PLACES	mm	INCH	DRAWN BY JENNIFER	DATE 1987/09/21	TITLE C-GRID, SHROUDED HEADER R/A (SLOTTED W/O STANDOFFS)			
	 =0	3 PLACES	± ---	± ---	CHECKED BY MLA1	DATE 1987/09/21	MOLEX MOLEX INCORPORATED			
	 =0	2 PLACES	± 0.20	± ---	APPROVED BY MLONG	DATE 2009/11/10	MATERIAL NO. SEE TABLE	DOCUMENT NO. SDA-70247-**-00-04	SHEET NO. 2 OF 2	
	1 PLACE	± ---	± ---	ANGULAR ± 3 °		THIS DRAWING CONTAINS INFORMATION THAT IS PROPRIETARY TO MOLEX INCORPORATED AND SHOULD NOT BE USED WITHOUT WRITTEN PERMISSION				
	DRAFT WHERE APPLICABLE MUST REMAIN WITHIN DIMENSIONS									