



The Infinite Bandwidth Company™

MIC94050/94051

4-Terminal TinyFET™ P-Channel MOSFET

Final

General Description

The MIC94050 and MIC94051 are 4-terminal silicon gate P-channel MOSFETs that provide low on-resistance in a very small package.

Designed for high-side switch applications where space is critical, the MIC94050/1 exhibits an on-resistance of typically 0.125Ω at 4.5V gate-to-source voltage. The MIC94050/1 also operates with only 1.8V gate-to-source voltage.

The MIC94050 is the basic 4-lead P-channel MOSFET. The MIC94051 is a variation that includes an internal gate pull-up resistor that can reduce the system parts count in many applications.

The 4-terminal SOT-143 package permits a substrate connection separate from the source connection. This 4-terminal configuration improves the θ_{JA} (improved heat dissipation) and makes reverse-blocking switch applications practical.

The small size, low threshold, and low $R_{DS(on)}$ make the MIC94050/1 the ideal choice for PCMCIA, USB, back-up battery-power, and distributed power management applications.

Features

- 0.125Ω typical on-resistance at 4.5V gate-to-source voltage
- Operates with 1.8V gate-to-source voltage
- Separate substrate connection allows reverse-blocking

Applications

- Distributed power management
- PCMCIA card power management
- USB ports
- Battery-powered computers, peripherals
- Handheld bar-code scanners
- Portable communications equipment
- Reverse blocking battery management

Ordering Information

Part Number	Temp. Range*	Package	Pb-FREE
MIC94050BM4	-40°C to +150°C	SOT-143	NO
MIC94051BM4	-40°C to +150°C	SOT-143	NO
MIC94050YM4	-40°C to +150°C	SOT-143	YES
MIC94051YM4	-40° to +150°C	SOT-143	YES

* Operating Junction Temperature

Pin Configuration

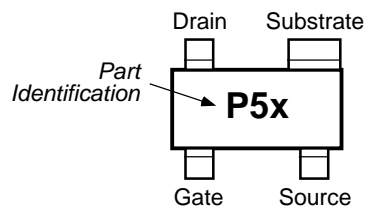

SOT-143 Package (M4)

Part Number	Identification
MIC94050BM4	P50
MIC94051BM4	P51
MIC94050YM4	P50
MIC94051YM4	P51

Typical PCB Layout

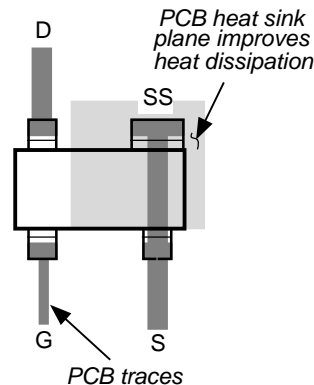

Schematic Symbol

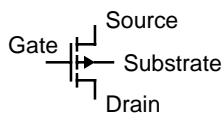

Schematic Symbol

Functional Diagrams

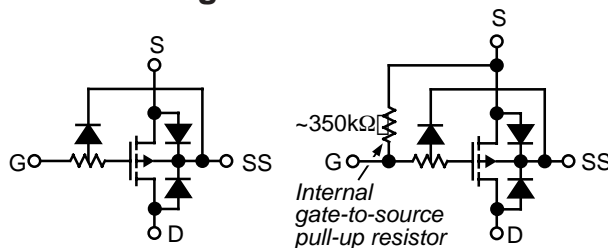

MIC94050

MIC94051

TinyFET is a trademark of Micrel, Inc.

Micrel, Inc. • 1849 Fortune Drive • San Jose, CA 95131 • USA • tel + 1 (408) 944-0800 • fax + 1 (408) 944-0970 • <http://www.micrel.com>

Absolute Maximum Ratings

Drain-to-Source Voltage	-6V
Gate-to-Source Voltage	-6V
Continuous Drain Current	
$T_A = 25^\circ\text{C}$ ($V_{GS} = 4.5\text{V}$)	1.8A
$T_A = 100^\circ\text{C}$ ($V_{GS} = 4.5\text{V}$)	1.2A
Total Power Dissipation	
$T_A = 25^\circ\text{C}$	568mW
$T_A = 100^\circ\text{C}$	227mW
Operating Junction Temperature	-40°C to +150°C
Storage Temperature	-55°C to +150°C
ESD Rating, Note 2	

Operating Ratings

Thermal Resistance	
θ_{JA}	220°C/W
θ_{JC}	130°C/W

Electrical Characteristics (Note 1)

Symbol	Parameter	Condition (Note 1)	Min	Typ	Max	Units
V_{GS}	Gate Threshold Voltage	$V_{DS} = V_{GS}$, $I_D = -250\mu\text{A}$	0.5		1.2	V
I_{GSS}	Gate-Body Leakage	$V_{DS} = 0\text{V}$, $V_{GS} = -4.5\text{V}$, Note 2, Note 3			1	μA
R_{GS}	Gate-Source Resistance	$V_{DS} = 0\text{V}$, $V_{GS} = -4.5\text{V}$, Note 2, Note 4	200	350	500	$\text{k}\Omega$
C_{ISS}	Input Capacitance	$V_{GS} = 0\text{V}$, $V_{DS} = -5.5\text{V}$		600		pF
I_{DSS}	Zero Gate Voltage Drain Current	$V_{DS} = -5.5\text{V}$, $V_{GS} = 0\text{V}$			1	μA
		$V_{DS} = -5.5\text{V}$, $V_{GS} = 0\text{V}$, $T_J = 85^\circ\text{C}$			5	μA
$R_{DS(ON)}$	Drain-Source On-Resistance	$V_{GS} = -4.5\text{V}$, $I_D = -100\text{mA}$		0.125	0.160	Ω
		$V_{GS} = -3.6\text{V}$, $I_D = -100\text{mA}$		0.135	0.180	Ω
		$V_{GS} = -2.5\text{V}$, $I_D = -100\text{mA}$		0.165	0.200	Ω
		$V_{GS} = -1.8\text{V}$, $I_D = -100\text{mA}$		0.225	0.280	Ω
g_{FS}	Forward Transconductance	$V_{DS} = -5.5\text{V}$, $I_D = -200\text{mA}$, Note 5		3		S

Note 1. $T_A = 25^\circ\text{C}$ unless noted. Substrate connected to source for all conditions.

Note 2. ESD gate protection diode conducts during positive gate-to-source voltage excursions. IC devices are inherently ESD sensitive. Handling precautions required

Note 3. MIC94050 only.

Note 4. MIC94051 only.

Note 5. Pulse Test: Pulse Width $\leq 80\mu\text{s}$, Duty Cycle $\leq 0.5\%$.

Typical Characteristics

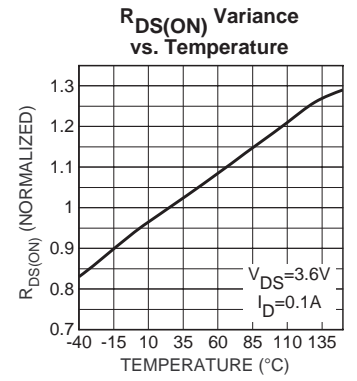
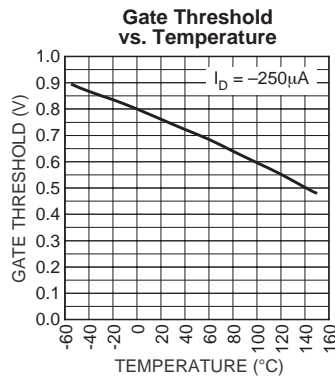
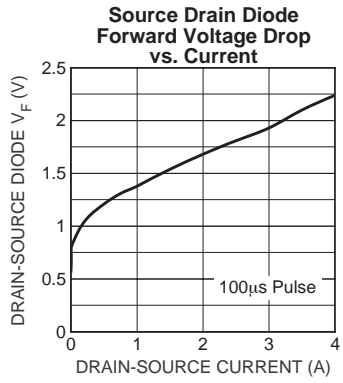
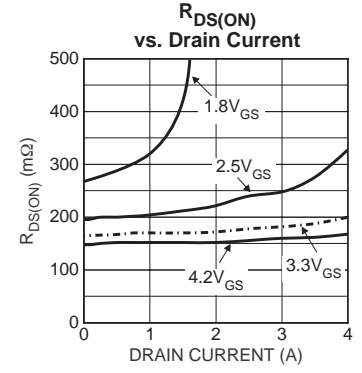
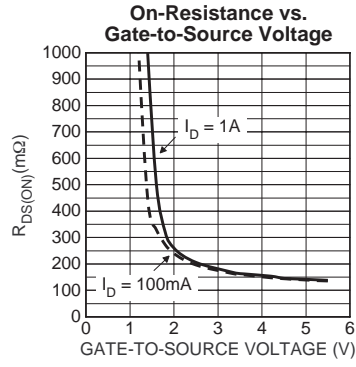
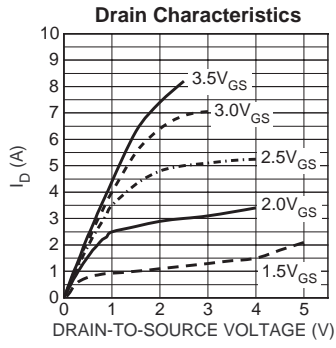

Typical Applications

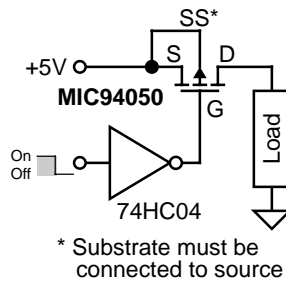

Figure 1. Load Switch Application

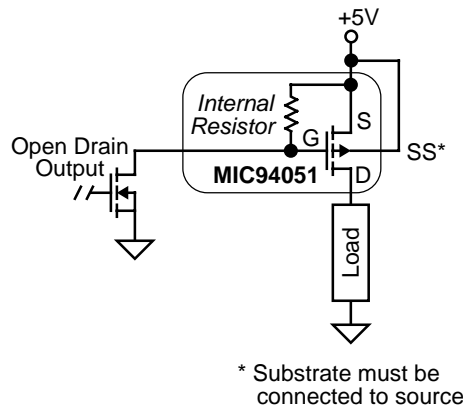

Figure 2. Load Switch Application (with internal gate-source pull-up)

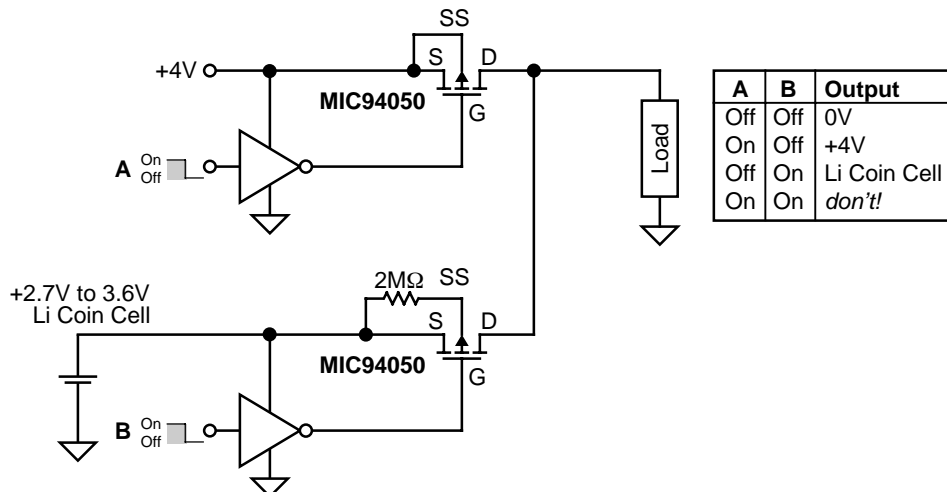
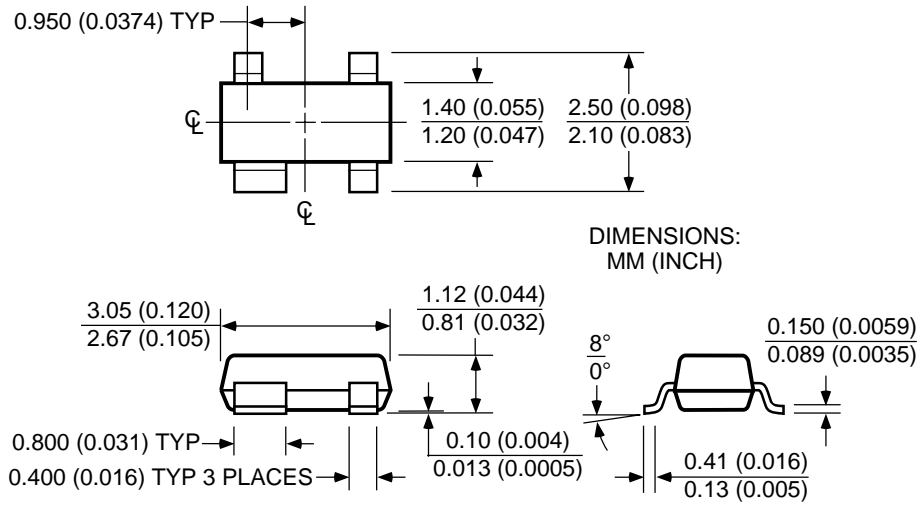

Figure 3. Reverse-Blocking Battery Back-Up Application

Package Information



SOT-143 (M4)

MICREL, INC. 1849 FORTUNE DRIVE SAN JOSE, CA 95131 USA

TEL + 1 (408) 944-0800 FAX + 1 (408) 944-0970 WEB <http://www.micrel.com>

This information is believed to be accurate and reliable, however no responsibility is assumed by Micrel for its use nor for any infringement of patents or other rights of third parties resulting from its use. No license is granted by implication or otherwise under any patent or patent right of Micrel, Inc.

© 2002 Micrel, Incorporated