



SERIES: EMSA 18W

DESCRIPTION: SWITCHING POWER SUPPLY

FEATURES

- universal AC input
- regulated output voltage
- short circuit protection
- meets EISA / efficiency level V regulations
- custom designs available



MODEL	output voltage		output current		output wattage	ripple*	efficiency level	cord length (mm)
	nominal (V dc)		min (A)	max (A)	max (W)	max. (mVp-p)		
EMSA050300	5		0	3.0	15	150	V	1530 ±100
EMSA060300	6		0	3.0	18	150	V	1530 ±100
EMSA090200	9		0	2.0	18	150	V	1530 ±100
EMSA120150	12		0	1.5	18	150	V	1530 ±100
EMSA150120	15		0	1.2	18	150	V	1530 ±100
EMSA180100	18		0	1.0	18	180	V	1530 ±100
EMSA200090	20		0	0.9	18	200	V	1530 ±100
EMSA240075	24		0	0.75	18	240	V	1530 ±100

*at full load, 100 ~ 240 V ac input, measured at 20MHz bandwidth with a 10 uF electrolytic cap and a 0.1 uF ceramic cap on the output

PART NUMBER KEY

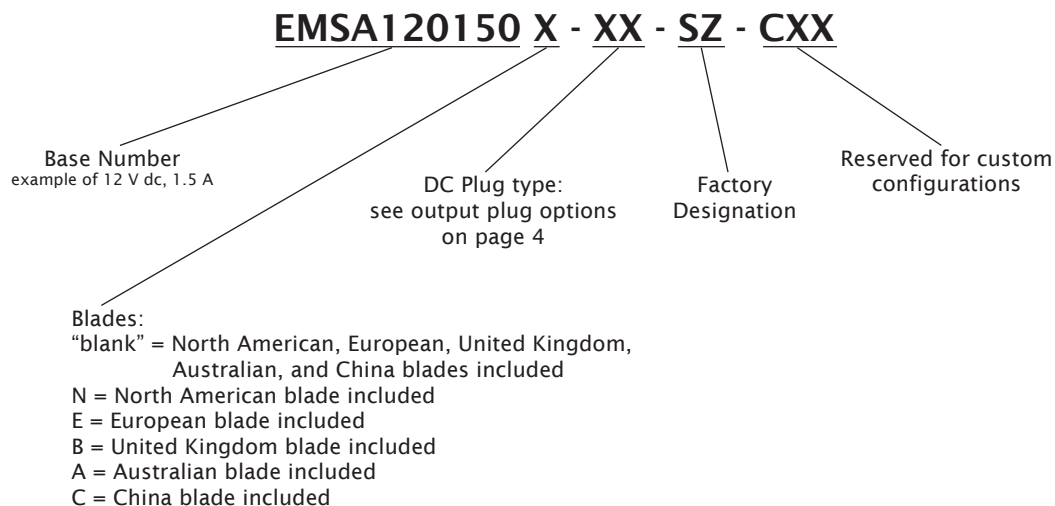



SERIES: EMSA 18W

DESCRIPTION: SWITCHING POWER SUPPLY

INPUT

parameter	conditions/description	min	nom	max	units
rated input voltage		100		240	V ac
input voltage range		90		264	V ac
rated frequency		50		60	Hz
frequency range		47		63	Hz
rated input current				0.6	A
inrush current	5, 6 V output: 115 V ac, cold start 5, 6 V output: 230 V ac, cold start all other outputs: 115 V ac, cold start all other outputs: 230 V ac, cold start			30 60 40 80	A A A A
no load power consumption				0.3	W

OUTPUT

parameter	conditions/description	min	nom	max	units
line regulation			±1		%
load regulation			±5		%
over voltage protection	output voltage clamped by internal protection zener				
short circuit protection	output shut down and auto-restart				

SAFETY & EMI

parameter	conditions/description	min	nom	max	units
HI-POT	input to output at 10 mA for 1 minute			3,000 4,242	V ac V dc
insulation resistance	input to output at 500 V dc	100			MΩ
safety approvals	UL/cUL, GS, RCM, BSMI				
EMI standard	FCC class B, CE, VCCI-II				
leakage current				0.25	mA
RoHS compliant	yes				

ENVIRONMENTAL

parameter	conditions/description	min	nom	max	units
operating temperature		0		40	°C
operating humidity		20		80	%
storage temperature		-10		75	°C
storage humidity		10		90	%



SERIES: EMSA 18W

DESCRIPTION: SWITCHING POWER SUPPLY

MECHANICAL DRAWING

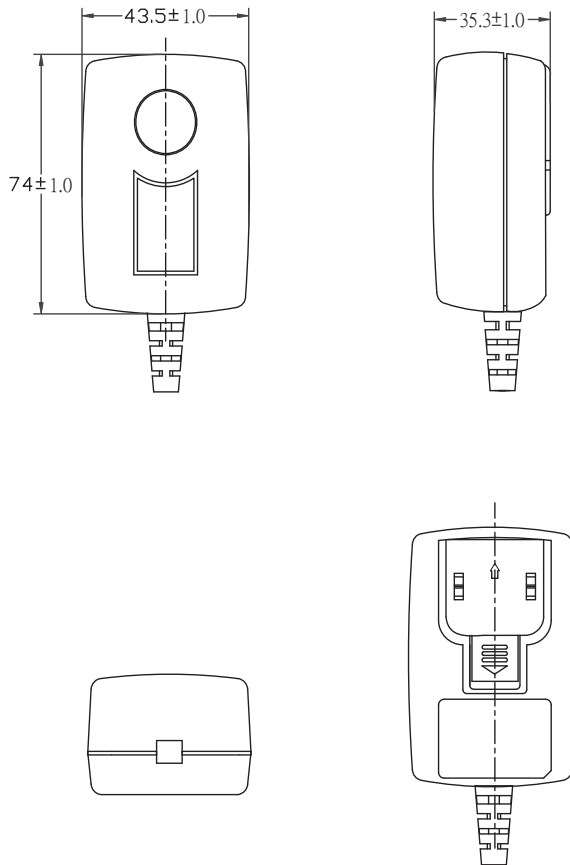

input plug	multi-blade (UL, VDE, UK, SAA, CCC)
weight	167 g
case size	74 L x 43.5 W x 35.3 H mm tolerance: ±1 mm

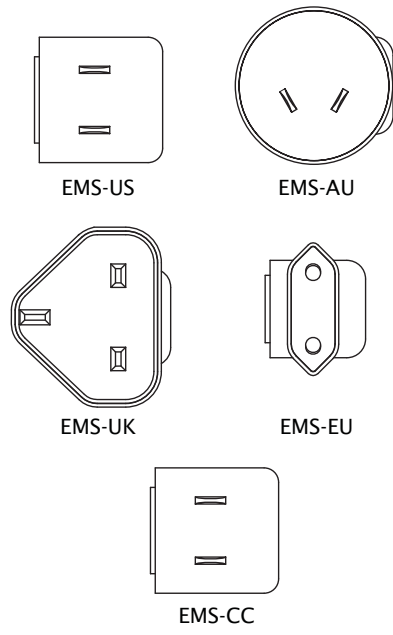

DC CORD

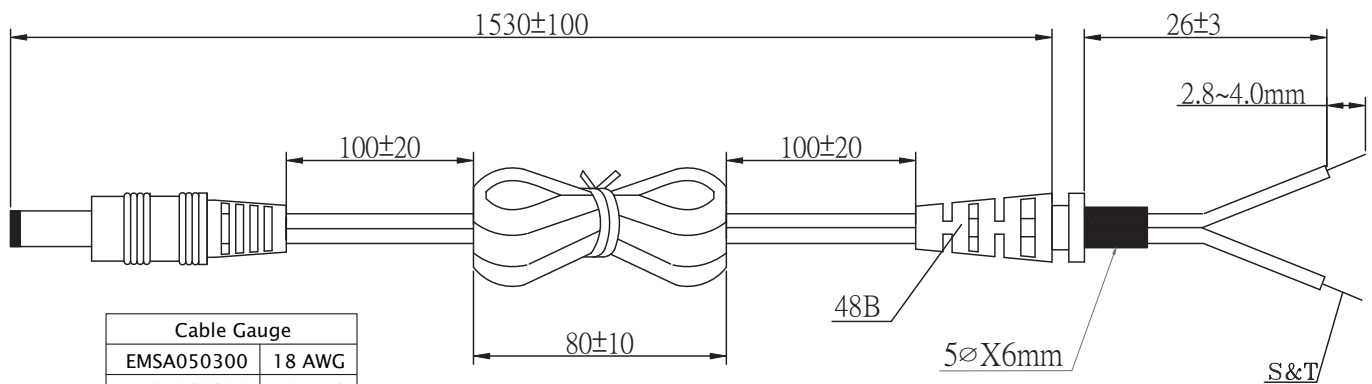

Cable Gauge	
EMSA050300	18 AWG
EMSA060300	18 AWG
EMSA090200	20 AWG
EMSA120150	20 AWG
EMSA150120	20 AWG
EMSA180100	22 AWG
EMSA200090	22 AWG
EMSA240075	22 AWG

Black wire, white stripe: Positive



SERIES: EMSA 18W

DESCRIPTION: SWITCHING POWER SUPPLY

OUTPUT PLUG OPTIONS

3.5 mm Phono Plug

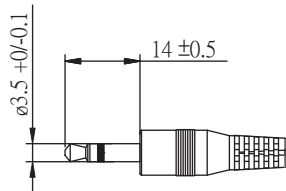

P1

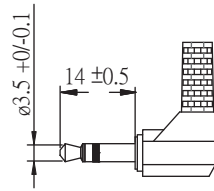

P1R

*Tip positive

Standard DC Plug

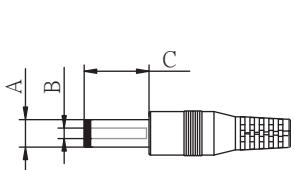

Standard PX

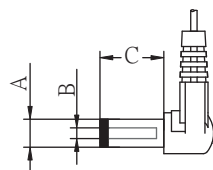

Right Angle PXR

	A	B	C	Unit
P5/P5R	5.5	2.1	9.5	mm
P6/P6R	5.5	2.5	9.5	mm
P7/P7R	3.5	1.3	9.5	mm
P8/P8R	3.8	1.35	9.5	mm
P9/P9R	3.8	1.05	9.5	mm

Locking DC Plug

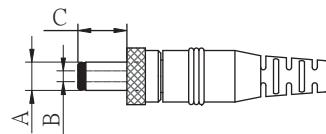

	A	B	C	Unit
P10	5.5	2.1	9.5	mm
P11	5.5	2.5	9.5	mm

EIAJ Plugs

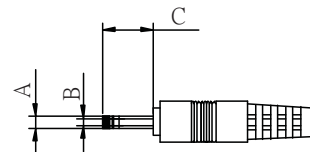

Standard PXX

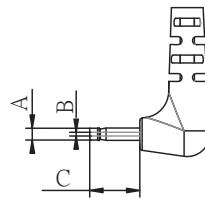

Right Angle PXXR

	EIAJ	A	B	C	D	Unit
P12/P12R	EIAJ-1	2.35	0.7	9.5	NA	mm
P13/P13R	EIAJ-2	4.0	1.7	9.5	5.0	mm
P14/P14R	EIAJ-3	4.75	1.7	9.5	5.0	mm

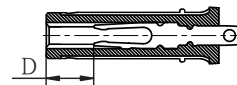

Stripped and Tinned

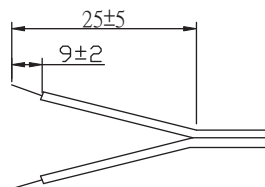

DC PLUG TYPE

ST
stripped and tinned

PXX X X

Plug type Plug angle:
"blank" = standard
R = right angle Plug polarity:
"blank" = N/A
P = center positive ⊖ — ⊕
N = center negative ⊕ — ⊖

*Contact CUI for additional output plug options.



SERIES: EMSA 18W

DESCRIPTION: SWITCHING POWER SUPPLY

INDIVIDUAL PACKAGING

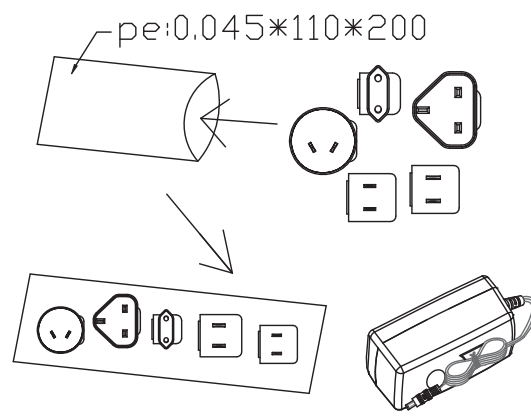

tolerance ± 1 mm

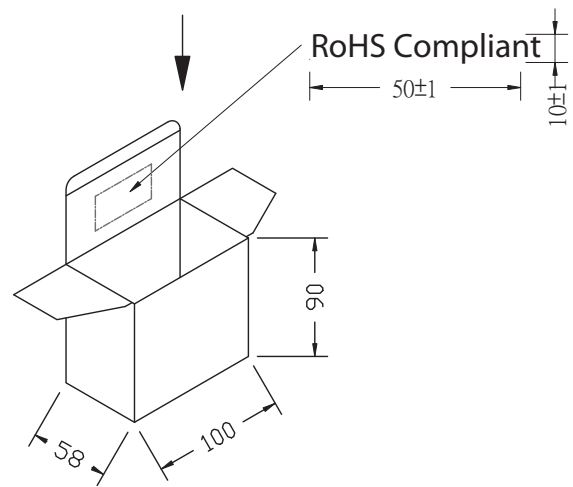

PACKAGING

tolerance $+7 / -0$ mm

EXTERNAL CARTON MATERIAL:A=B(6mm)

INTERNAL CARTON MATERIAL:B3B(3mm)

CARTON SIZE: 485X428X210mm

Q'TY: 60pcs(20x3x1)

"RoHS Compliant"

