



YENYO

HFR15A06

Glass Passivated Hyperfast Recovery Rectifier

Features

- ★ Fast switching for high efficiency
- ★ Low noise
- ★ $T_{rr} = 30\text{ns}$
- ★ Low reverse leakage current
- ★ High voltage super FRD
- ★ PFC application

Mechanical Data

- ★ Case: Molded plastic TO-220AC
- ★ Epoxy: UL 94V-0 rate flame retardant ,
- ★ Terminals: Solderable per MIL-STD-202 method 208
- ★ Mounting position: Any
- ★ Weight: 2.07 grams

Voltage Range 600 V
Current 15.0 Ampere

TO-220AC

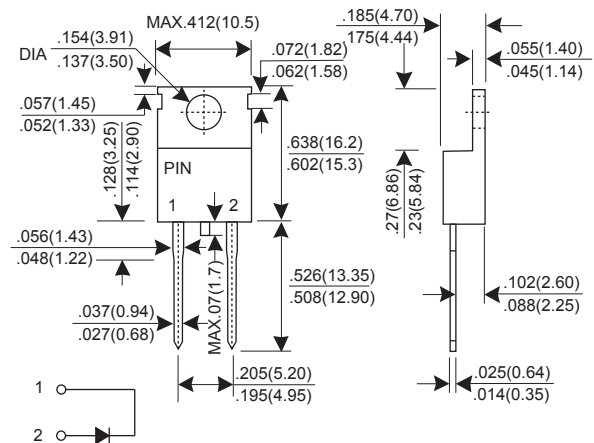

Dimensions in inches and (millimeters)

MAXIMUM RATINGS AND ELECTRICAL CHARACTERISTICS

Rating at 25°C ambient temperature unless otherwise specified.

Single phase, half wave, 60Hz, resistive or inductive load.

For capacitive load, derate current by 20%.

CHARACTERISTIC	SYMBOL	HFR15A06			UNIT
		Min.	Typ.	Max.	
Recurrent Peak Reverse Voltage	VRRM	-	-	600	V
RMS Voltage	VRMS	-	-	420	V
DC Blocking Voltage	VDC	-	-	600	V
Average Forward Rectified Current $T_c=140^\circ\text{C}$	IF(AV)	-	-	15.0	A
Peak Forward Surge Current, 8.3ms single Half sine-wave superimposed on rated load (JEDEC method)	IFSM	-	-	200	A
Instantaneous Forward Voltage @15A(25°C) @15A(150°C)	VF	-	-	2.4 1.8	V
DC Reverse Current @ $T_J=25^\circ\text{C}$ At Rated DC Blocking Voltage @ $T_J=150^\circ\text{C}$	IR	-	-	10 500	uA
Maximum Reverse Recovery Time (Note 1)	Trr	-	-	30	nS
Maximum Power Dissipation	Pd	-	-	100	W
Typical junction Capacitance (Note 2)	CJ	-	60	-	pF
Typical Thermal Resistance (Note 3)	RθJC	-	-	1.5	°CW
Operating Junction and Storage Temperature Range	TJ, TSTG	-65	-	175	°C

NOTES : (1) Reverse recovery test conditions $I_F = 0.5\text{A}$, $I_R = 1.0\text{A}$, $I_{rr} = 0.25\text{A}$.

(2) Junction Capacitance test conditions : $V_R = 10\text{V}$, $I_F = 0\text{A}$.

(3) Thermal Resistance junction to case.

RATINGS AND CHARACTERISTIC CURVES HFR15A06

FIG.1 - FORWARD CURRENT DERATING CURVE

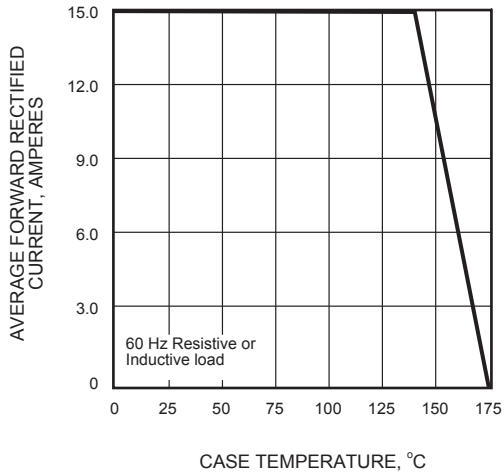

FIG.2 - MAXIMUM NON-REPETITIVE PEAK FORWARD SURGE CURRENT

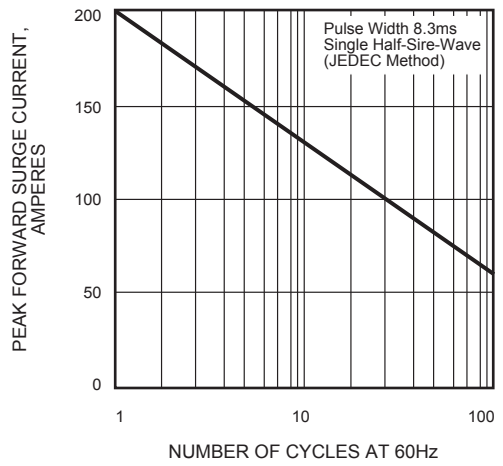

FIG.3 - TYPICAL INSTANTANEOUS FORWARD CHARACTERISTICS

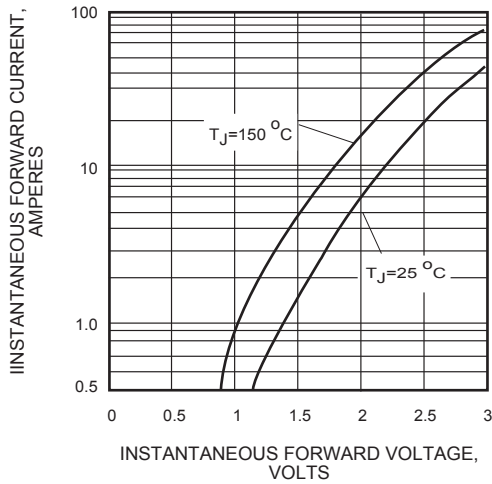

FIG.4 - TYPICAL REVERSE CHARACTERISTICS

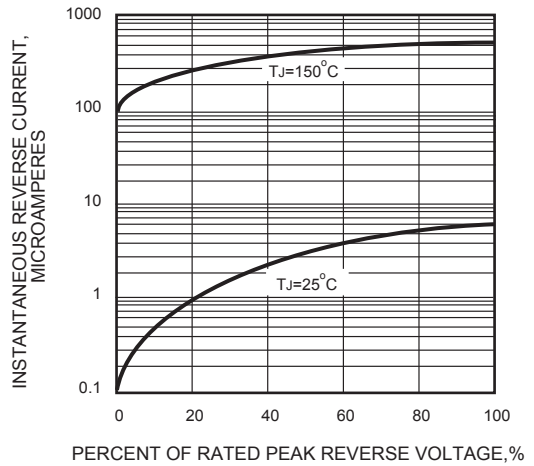

FIG.5 - t_{rr} , t_a AND t_b CURVES vs FORWARD CURRENT

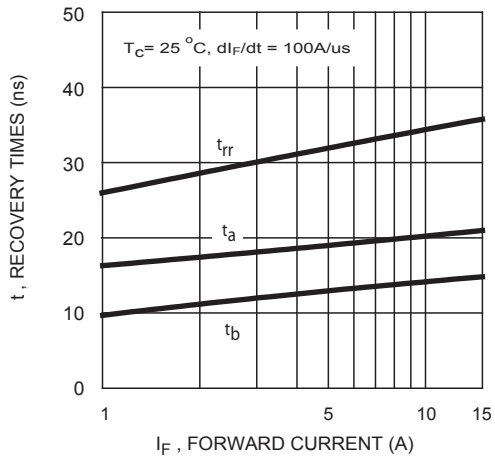
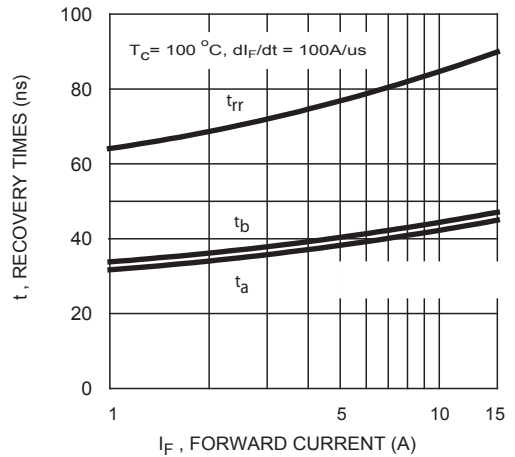

FIG.6 - t_{rr} , t_a AND t_b CURVES vs FORWARD CURRENT



RATINGS AND CHARACTERISTIC CURVES HFR15A06

FIG.7 - T_{rr} , t_a AND t_b CURVES vs FORWARD CURRENT

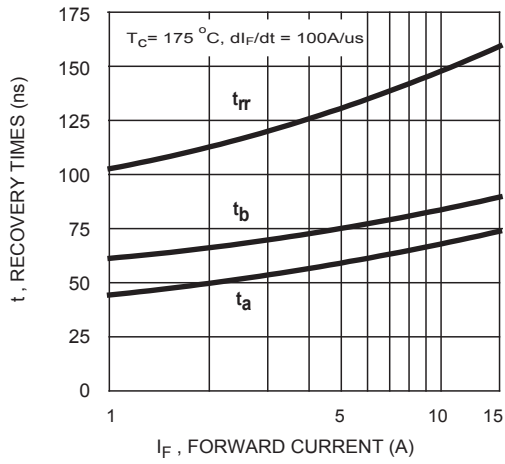

FIG.8 - TYPICAL JUNCTION CAPACITANCE

