

cosmo**High Reliability Photocoupler KTLP160G**

UL 1577 (File No.E169586) VDE EN60747-5-2 (File No.40009235)

Features

1. Opaque type, mini-flat package.
2. Subminiature type
(The volume is smaller than that of our conventional DIP type by as far as 30%)
3. Isolation voltage between input and output (Viso:2500Vrms).

For 115/240 Vac (rms) Application:

1. Solenoid/Valve Controls.
2. Lighting Controls.
3. Static Power Switches.
4. AC Motor Drives.
5. Temperature Controls.
6. E.M. Contactors.
7. AC Motor Staters.
8. Solid State Relays.
9. Programmable controllers.

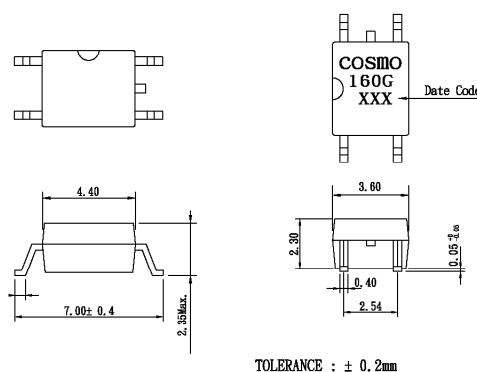
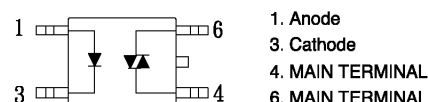
Outside Dimension:Unit (mm)**Schematic:Top View****Absolute Maximum Ratings**

(Ta=25°C)

	Parameter	Symbol	Rating	Unit
Input	Forward current	IF	50	mA
	Peak forward current (100us)	IFM	1	A
	Reverse voltage	VR	6	V
	Power dissipation	PD	70	mW
Output	Off-State Output Terminal voltage	VDRM	400	Vpeak
	On-State R. M. S. Current	IT(RMS)	70	mA
	Peak Repetitive Surget Current (PW=10ms, DC 10%)	ITSM	1	A
	Power dissipation	PD	150	mW
	Total power dissipation	Ptot	200	mW
	Isolation voltage 1 minute	Viso	2500	Vrms
	Operating temperature	Topr	-40 to +100	°C
	Storage temperature	Tstg	-50 to +125	°C
	Soldering temperature 10 second	Tsol	260	°C

Electro-optical Characteristics

(Ta=25°C)

	Parameter	Symbol	Conditions	MIN.	TYP.	MAX.	Unit
Input	Forward voltage	VF	IF=10mA	—	1.2	1.4	V
	Peak forward voltage	VFM	IFM=0.5A	—	—	3.5	V
	Reverse Leakage Current	IR	VR=5V	—	—	10	μA
Output	Peak Blocking Current	IDRM	VDRM=400V	—	—	1.0	μA
	ON-State Voltage	VTM	ITM=70mA	—	1.6	2.8	V
Transfer characteristics	Holding Current	IH		—	1.0	—	mA
	Critical rate of rise of OFF-state voltage	dV/dt	VDRM= (1/√2) *Rated	600	—	—	V/μS
	Isolation resistance	Riso	DC500V	5x10 ¹⁰	10 ¹¹	—	ohm
	Minimum trigger current	IFT	Main Terminal Voltage=3V	—	5	10	mA
	Turn-on time	Ton	Vd=6V, RL=100 ohm, IF=20mA	—	—	100	μS

Classification table of Trigger LED current is shown below.

(Ta=25°C)

Classification	Trigger LED Current (mA)	
	Min.	Max.
1 (Standard)	-	10
2	-	7
3	-	5

Fig.1 Forward Current vs. Ambient Temperature

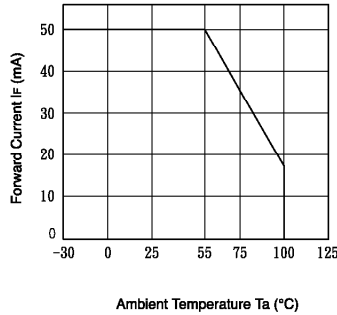

Fig.2 Diode Power Dissipation vs. Ambient Temperature

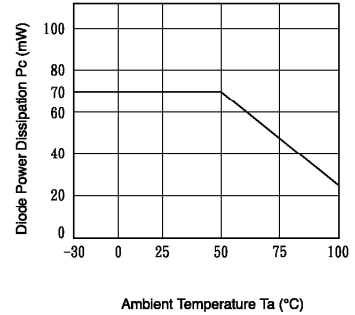

Fig.3 On-State R. M. S. Current vs. Ambient Temperature

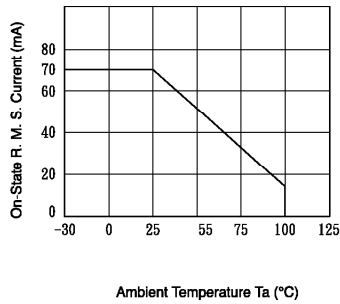

Fig.4 Total Power Dissipation vs. Ambient Temperature

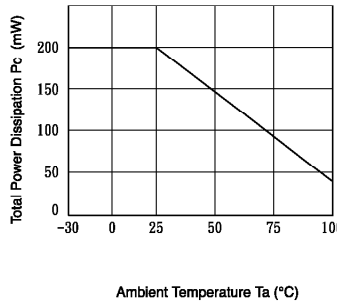

Fig.5 Peak Forward Current vs. Duty Ratio

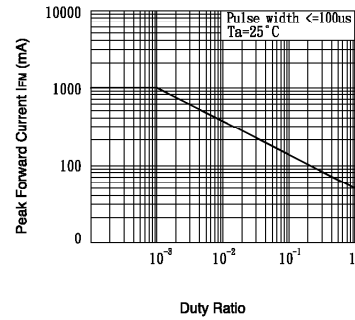

Fig.6 Forward Current vs. Forward Voltage

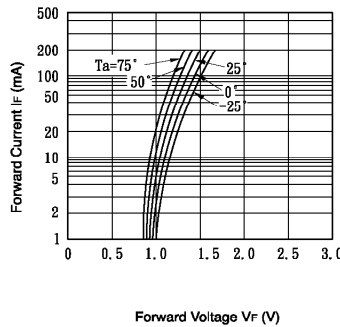

Fig.7 On-State Characteristics

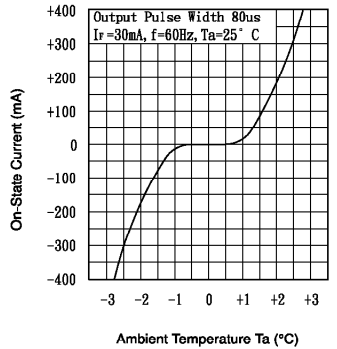

Fig.8 Leakage with LED off vs. Ambient Temperature

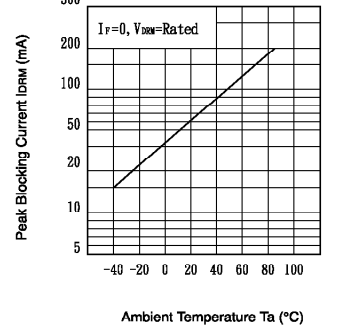

Fig.9 Trigger Current vs. Ambient Temperature

