

# PBL 3717/2 Stepper Motor Drive Circuit

## Description

PBL 3717/2 is a bipolar monolithic circuit intended to control and drive the current in one winding of a stepper motor.

The circuit consists of a LS-TTL compatible logic input stage, a current sensor, a monostable multivibrator and a high power H-bridge output stage with built-in protection diodes.

Two PBL 3717/2 and a small number of external components form a complete control and drive unit for LS-TTL or microprocessor-controlled stepper motor systems.

- Half-step and full-step modes.
- Switched mode bipolar constant current drive
- Wide range of current control 5 — 1200 mA.
- Wide voltage range 10 — 45 V.
- Designed for unstabilized motor supply voltage.
- Current levels can be selected in steps or varied continuously.
- Thermal overload protection.
- Built-in recirculation diodes.

DataSheet4U.com

DataShee

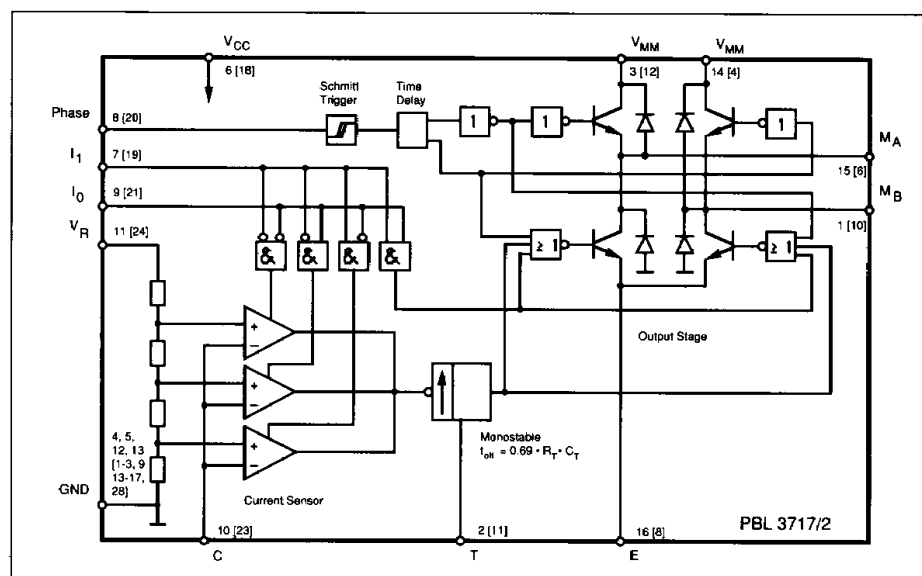
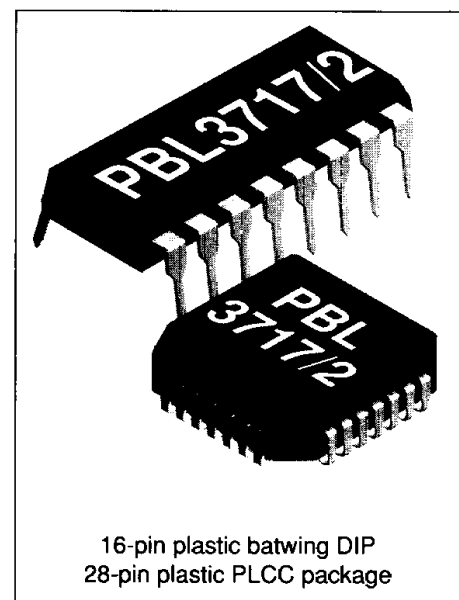

Figure 1. Block diagram



## Maximum Ratings

Parameter	Pin no. *	Symbol	Min	Max	Unit
<b>Voltage</b>					
Logic supply	6 [18]	$V_{CC}$	0	7	V
Motor supply	3, 14 [4, 12]	$V_{MM}$	0	45	V
Logic inputs	7, 8, 9 [19, 20, 21]	$V_I$	-0.3	6	V
Comparator input	10 [23]	$V_C$	-0.3	$V_{CC}$	V
Reference input	11 [24]	$V_R$	-0.3	15	V
<b>Current</b>					
Motor output current	1, 15 [6, 10]	$I_M$	-1.2	+1.2	A
Logic inputs	7, 8, 9 [19, 20, 21]	$I_I$	-10		mA
Analog inputs	10, 11 [23, 24]	$I_A$	-10		mA
<b>Temperature</b>					
Junction temperature		$T_J$		+150	°C
Operating ambient temperature		$T_a$	0	+70	°C
Storage temperature		$T_s$	-55	+150	°C

\* [no] refers to PLCC package pin no.

## Recommended Operating Conditions

Parameter	Symbol	Min	Typ	Max	Unit
Logic supply voltage	$V_{CC}$	4.75	5	5.25	V
Motor supply voltage	$V_{MM}$	10		40	V
Motor output current	$I_M$	-1.0		+1.0	A
Ambient temperature	$T_a$	0		+70	°C
Rise time logic inputs	$t_r$			2	μs
Fall time logic inputs	$t_f$			2	μs

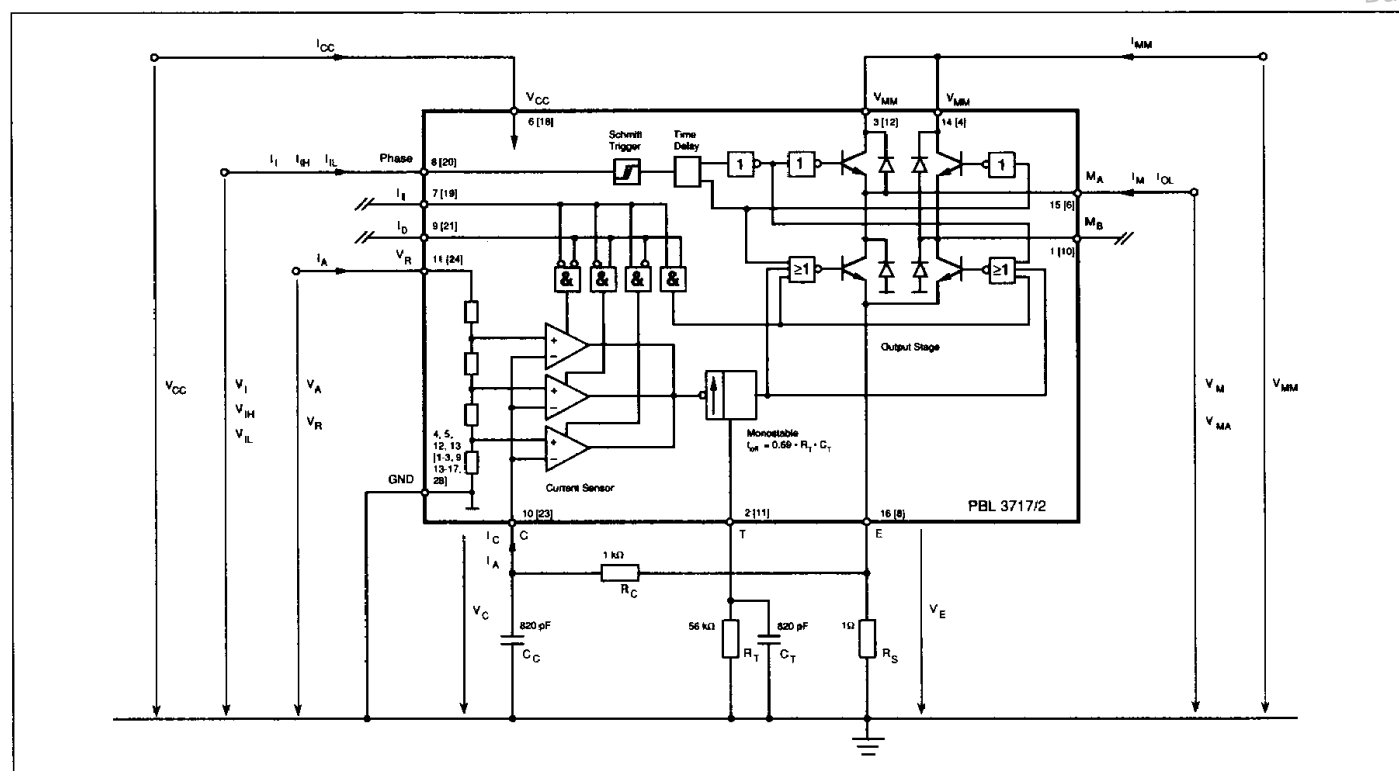

Figure 2. Definition of symbols.

## Electrical Characteristics

Electrical characteristics over recommended operating conditions.  $C_T = 820$  pF,  $R_T = 56$  kohm.

Parameter	Symbol	Ref. fig.	Conditions	Min	Typ	Max	Unit
<b>General</b>							
Supply current	$I_{CC}$	2				25	mA
Total power dissipation	$P_D$		$f_s = 28$ kHz, $I_M = 0.5$ A, $V_{MM} = 36$ V		1.4	1.7	W
			Note 2, 4.				
			$f_s = 28$ kHz, $I_M = 0.8$ A, $V_{MM} = 36$ V		2.8	3.3	W
			Note 3, 4.				
Turn-off delay	$t_d$	3	$T_a = +25^\circ\text{C}$ , $dV_C/dt \geq 50$ mV/ $\mu\text{s}$ .		0.9	1.5	$\mu\text{s}$
Thermal shutdown junction temperature					170		$^\circ\text{C}$
<b>Logic Inputs</b>							
Logic HIGH input voltage	$V_{IH}$	2		2.0			V
Logic LOW input voltage	$V_{IL}$	2				0.8	V
Logic HIGH input current	$I_{IH}$	2	$V_I = 2.4$ V			20	$\mu\text{A}$
Logic LOW input current	$I_{IL}$	2	$V_I = 0.4$ V	-0.4			mA
<b>Reference Input</b>							
Input resistance	$R_R$		$T_a = +25^\circ\text{C}$		6.8		kohm
<b>Comparator Inputs</b>							
Threshold voltage	$V_{CH}$	2	$V_R = 5.0$ V, $I_0 = I_1 = \text{LOW}$	400	415	430	mV
Threshold voltage	$V_{CM}$	2	$V_R = 5.0$ V, $I_0 = \text{HIGH}$ , $I_1 = \text{LOW}$	240	250	265	mV
Threshold voltage	$V_{CL}$	2	$V_R = 5.0$ V, $I_0 = \text{LOW}$ , $I_1 = \text{HIGH}$	70	80	90	mV
Input current	$I_C$	2		-20			$\mu\text{A}$
<b>Motor Outputs</b>							
Lower transistor saturation voltage		2	$I_M = 0.5$ A		0.9	1.2	V
			$I_M = 0.8$ A		1.1	1.4	V
Lower diode forward voltage drop		2	$I_M = 0.5$ A		1.2	1.5	V
			$I_M = 0.8$ A		1.3	1.7	V
Upper transistor saturation voltage		2	$I_M = 0.5$ A		1.0	1.25	V
			$I_M = 0.8$ A		1.2	1.5	V
Upper diode forward voltage drop		2	$I_M = 0.5$ A		1.0	1.25	V
			$I_M = 0.8$ A		1.2	1.45	V
Output leakage current		2	$I_0 = I_1 = \text{HIGH}$ , $T_a = +25^\circ\text{C}$			100	$\mu\text{A}$
<b>Monostable</b>							
Cut off time	$t_{off}$	3	$V_{MM} = 10$ V, $t_{on} \geq 5$ $\mu\text{s}$	27	31	35	$\mu\text{s}$

## Thermal Characteristics

Parameter	Symbol	Ref. Fig.	Conditions	Min	Typ	Max	Unit
Thermal resistance	$R_{th_{j-c}}$		DIP package.		11		$^\circ\text{C/W}$
	$R_{th_{j-a}}$	16	DIP package. Note 2.		40		$^\circ\text{C/W}$
	$R_{th_{j-c}}$		PLCC package.		9		$^\circ\text{C/W}$
	$R_{th_{j-a}}$	16	PLCC package. Note 2.		35		$^\circ\text{C/W}$

### Notes

- All voltages are with respect to ground. Currents are positive into, negative out of specified terminal.
- All ground pins soldered onto a 20 cm<sup>2</sup> PCB copper area with free air convection.  $T_a = +25^\circ\text{C}$ .
- DIP package with external heatsink (Staver V7) and minimal copper area. Typical  $R_{th_{j-a}} = 27.5^\circ\text{C/W}$ .  $T_a = +25^\circ\text{C}$ .
- Not covered by final test program.

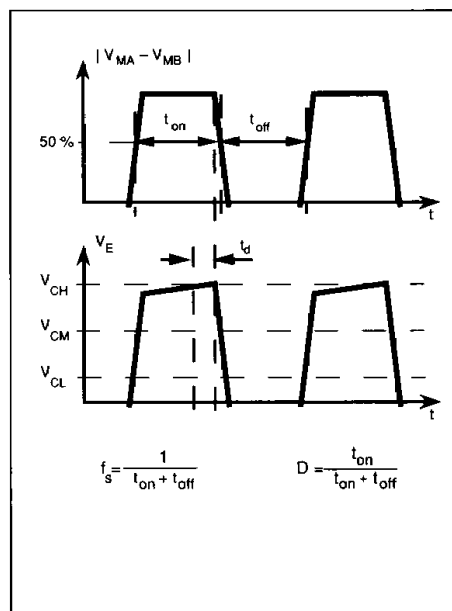

Figure 3. Definition of terms.

## Functional Description

The PBL 3717/2 is intended to drive a bipolar constant current through one motor winding of a 2-phase stepper motor.

Current control is achieved through switched-mode regulation, see figure 5 and 6.

Three different current levels and zero current can be selected by the input logic.

The circuit contains the following functional blocks:

- Input logic
- Current sense
- Single-pulse generator
- Output stage

### Input logic

**Phase input.** The phase input determines the direction of the current in the motor winding. High input forces the current from terminal  $M_A$  to  $M_B$  and low input from terminal  $M_B$  to  $M_A$ . A Schmitt trigger provides noise immunity and a delay circuit eliminates the risk of cross conduction in the output stage during a phase shift.

Half- and full-step operation is possible.

**Current level selection.** The status of  $I_0$  and  $I_1$  inputs determines the current level in the motor winding. Three fixed

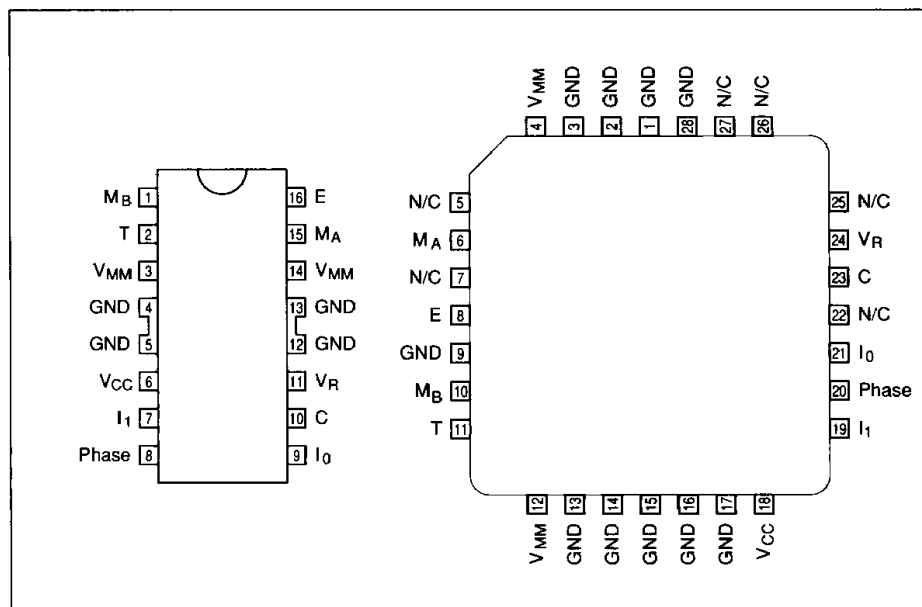

Figure 4. Pin configurations.

current levels can be selected according to the table below.

Motor current		$I_0$	$I_1$
High level	100%	L	L
Medium level	60%	H	L
Low level	20%	L	H
Zero current	0%	H	H

The specific values of the different current levels are determined by the reference voltage  $V_R$  together with the value of the sensing resistor  $R_S$ .

The peak motor current can be calculated as follows:

$$i_m = (V_R \cdot 0.083) / R_S \text{ [A]}, \text{ at 100\% level}$$

$$i_m = (V_R \cdot 0.050) / R_S \text{ [A]}, \text{ at 60\% level}$$

$$i_m = (V_R \cdot 0.016) / R_S \text{ [A]}, \text{ at 20\% level}$$

The motor current can also be continuously varied by modulating the voltage reference input.

### Current sensor

The current sensor contains a reference voltage divider and three comparators for measuring each of the selectable current levels. The motor current is sensed as a voltage drop across the current sensing resistor,  $R_S$ , and compared with one of the voltage references from the divider. When the two voltages are equal, the comparator triggers the single-pulse generator. Only one comparator at a time is activated by the input logic.

### Single-pulse generator

The pulse generator is a monostable multivibrator triggered on the positive edge of the comparator output. The multivibrator output is high during the pulse time,  $t_{off}$ , which is determined by the timing components  $R_T$  and  $C_T$ .

$$t_{off} = 0.69 \cdot R_T \cdot C_T$$

The single pulse switches off the power feed to the motor winding, causing the winding to decrease during  $t_{off}$ .

If a new trigger signal should occur during  $t_{off}$ , it is ignored.

### Output stage

The output stage contains four transistors and four diodes, connected in an H-bridge. The two sinking transistors are used to switch the power supplied to the motor winding, thus driving a constant current through the winding. See figures 5 and 6.

### Overload protection

The circuit is equipped with a thermal shut-down function, which will limit the junction temperature. The output current will be reduced if the maximum permissible junction temperature is exceeded. It should be noted, however, that it is not short circuit protected.

### Operation

When a voltage  $V_{MM}$  is applied across the motor winding, the current rise follows the equation:

$$i_m = (V_{MM} / R) \cdot (1 - e^{-(R \cdot t) / L})$$

R = Winding resistance

L = Winding inductance

t = time

(see figure 6, arrow 1)

The motor current appears across the external sensing resistor,  $R_S$ , as an analog voltage. This voltage is fed through a low-pass filter,  $R_C C_C$ , to the voltage comparator input (pin 10). At the moment the sensed voltage rises above the comparator threshold voltage, the monostable is triggered and its output turns off the conducting sink transistor.

The polarity across the motor winding reverses and the current is forced to circulate through the appropriate upper protection diode back through the source transistor (see figure 6, arrow 2).

After the monostable has timed out, the current has decayed and the analog voltage across the sensing resistor is below the comparator threshold level.

The sinking transistor then closes and the motor current starts to increase again. The cycle is repeated until the current is turned off via the logic inputs.

By reversing the logic level of the phase input (pin 8), both active transistors are turned off and the opposite pair turned on after a slight delay. When this happens, the current must first decay to zero before it can reverse. This current decay is steeper because the motor current is now forced to circulate back through the power supply and the appropriate sinking transistor protection diode. This causes higher reverse voltage build-up across the winding which results in a faster current decay (see figure 6, arrow 3).

For best speed performance of the stepper motor at half-step mode operation, the phase logic level should be changed at the same time the current-inhibiting signal is applied (see figure 2).

### Heatsinking

The junction temperature of the chip highly effects the lifetime of the circuit. In high-current applications, the heatsinking must be carefully considered.

The  $R_{th_{ja}}$  of the PBL 3717/2 can be reduced by soldering the ground pins to a suitable copper ground plane on the printed circuit board (see figure 16) or by applying an external heatsink type V7 or V8, see figure 15.

The diagram in figure 14 shows the

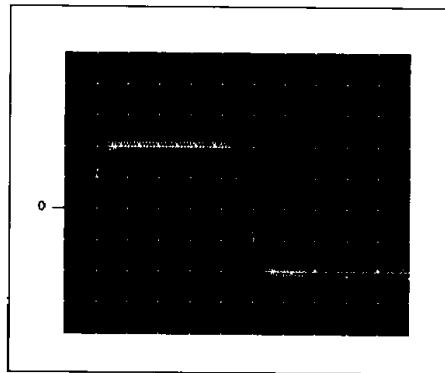

Figure 5. Motor current ( $I_M$ ),  
Vertical : 200 mA/div,  
Horizontal: 1 ms/div,  
expanded part 100  $\mu$ s/div.

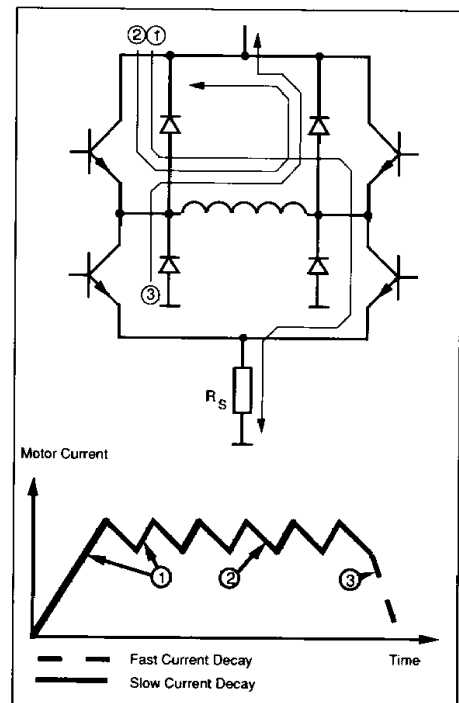

Figure 6. Output stage with current paths for fast and slow current decay.

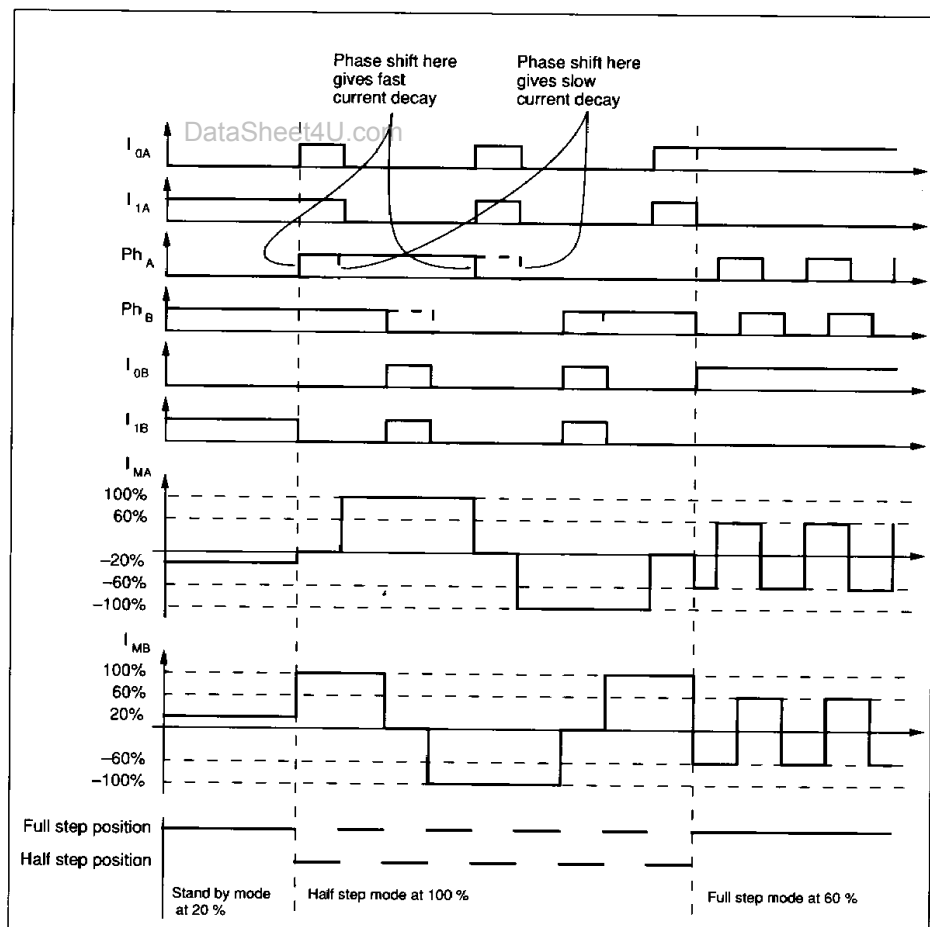

Figure 7. Principal operating sequence.

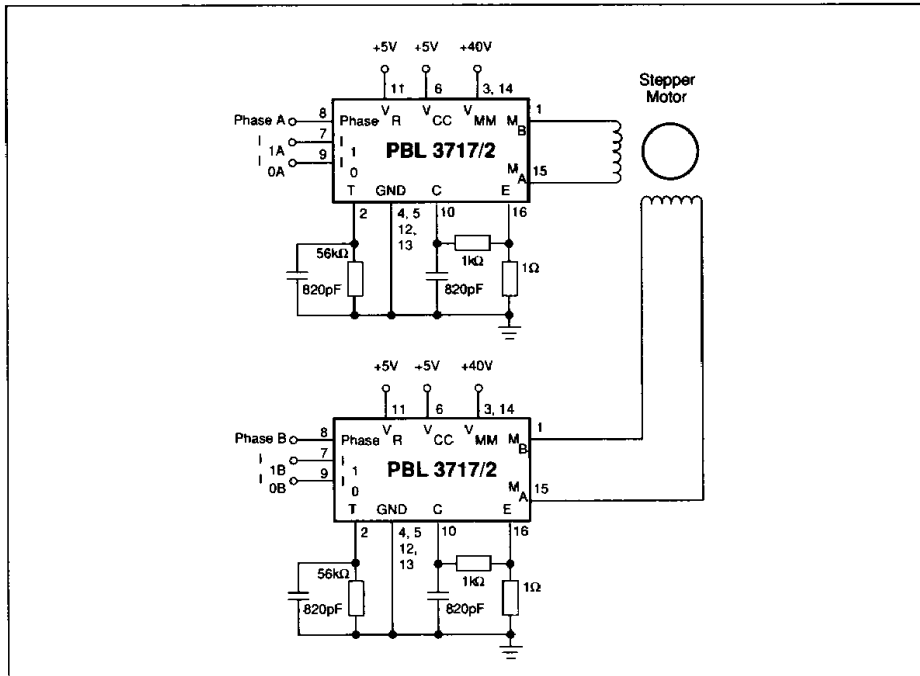

Figure 8. Typical stepper motor driver application with PBL 3717/2.

maximum permissible power dissipation versus the ambient temperature in °C, for heatsinks of the type V7, V8 or a 20 cm<sup>2</sup> copper area respectively. Any external heatsink or printed circuit board copper must be connected to electrical ground.

For motor currents higher than 500 mA, heatsinking is recommended to assure optimal reliability.

The diagrams in figures 13 and 14 can be used to determine the required heatsink of the circuit. In some systems, forced-air cooling may be available to reduce the temperature rise of the circuit.

## Applications Information

### Motor selection

Some stepper motors are not designed for continuous operation at maximum current. As the circuit drives a constant current through the motor, its temperature can increase, both at low- and high-speed operation.

Some stepper motors have such high core losses that they are not suited for switched-mode operation.

### Interference

As the circuit operates with switched-mode current regulation, interference-generation problems can arise in some applications. A good measure is then to decouple the circuit with a 0.1 μF ceramic capacitor, located near the package across the power line V<sub>MM</sub> and ground.

Also make sure that the V<sub>R</sub> input is sufficiently decoupled. An electrolytic capacitor should be used in the +5 V rail, close to the circuit.

The ground leads between R<sub>S</sub>, C<sub>C</sub> and circuit GND should be kept as short as possible. This applies also to the leads connecting R<sub>S</sub> and R<sub>C</sub> to pin 16 and pin 10 respectively.

In order to minimize electromagnetic interference, it is recommended to route M<sub>A</sub> and M<sub>B</sub> leads in parallel on the printed circuit board directly to the terminal connector. The motor wires should be twisted in pairs, each phase separately, when installing the motor system.

### Unused inputs

Unused inputs should be connected to proper voltage levels in order to obtain the highest possible noise immunity.

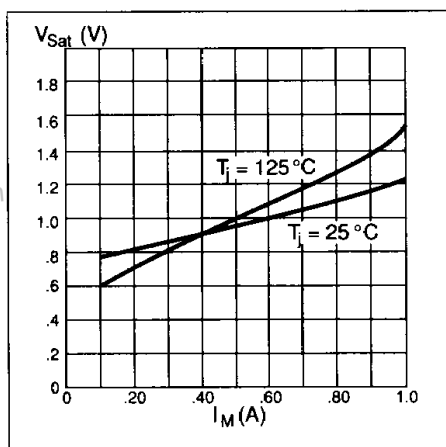

Figure 9. Typical source saturation vs. output current.

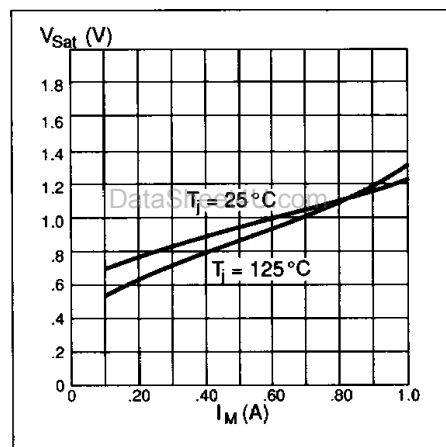

Figure 10. Typical sink saturation vs. output current.

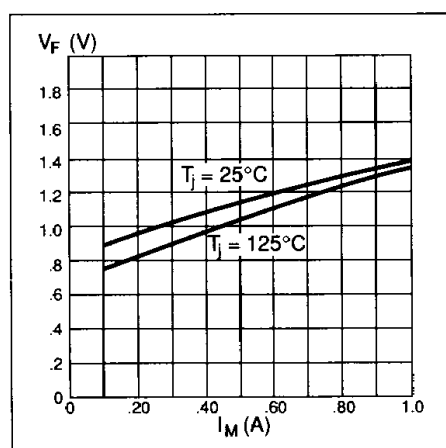

Figure 11. Typical lower diode voltage drop vs. recirculating current.

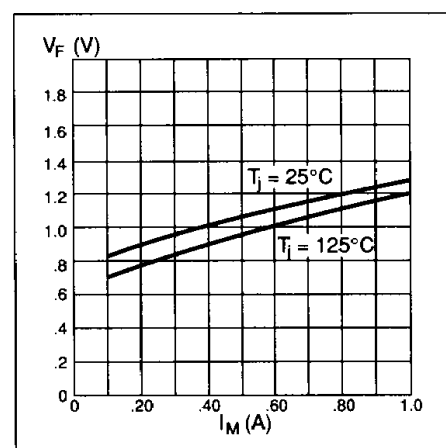

Figure 12. Typical upper diode voltage drop vs. recirculating current.

### Ramping

A stepper motor is a synchronous motor and does not change its speed due to load variations. This means that the torque of the motor must be large enough to match the combined inertia of the motor and load for all operation modes. At speed changes, it requires torque increases by the square, and the required power by the cube of the speed change. Ramping, i.e., controlled acceleration or deceleration must then be considered to avoid motor pull-out.

$V_{CC}$ ,  $V_{MM}$

The supply voltages,  $V_{CC}$  and  $V_{MM}$ , can be turned on or off in any order. Normal  $dV/dt$  values are assumed.

Before a driver circuit board is removed from its system, all supply voltages must be turned off to avoid destructive transients from being generated by the motor.

### Analog control

As the current levels can be continuously controlled by modulating the  $V_R$  input, limited microstepping can be achieved.

### Switching frequency

The motor inductance, together with the pulse time,  $t_{off}$ , determines the switching frequency of the current regulator. The choice of motor may then require other values on the  $R_T$ ,  $C_T$  components than those recommended in figure 7, to obtain a switching frequency above the audible range. Switching frequencies above 40 kHz are not recommended because the current regulation can be affected.

### Sensor resistor

The  $R_S$  resistor should be of a non-inductive type, power resistor. A 1.0 ohm resistor, tolerance  $\leq 1\%$ , is a good choice for 415 mA max motor current at  $V_R = 5V$ .

The peak motor current,  $i_m$ , can be calculated by using the formulas:

$$i_m = (V_R \cdot 0.083) / R_S [A], \text{ at } 100\% \text{ level}$$

$$i_m = (V_R \cdot 0.050) / R_S [A], \text{ at } 60\% \text{ level}$$

$$i_m = (V_R \cdot 0.016) / R_S [A], \text{ at } 20\% \text{ level}$$

### Ordering Information

Package	Temp. Range	Part No.
Plastic DIP	0 to 70°C	PBL 3717/2N
PLCC	0 to 70°C	PBL 3717/2QN

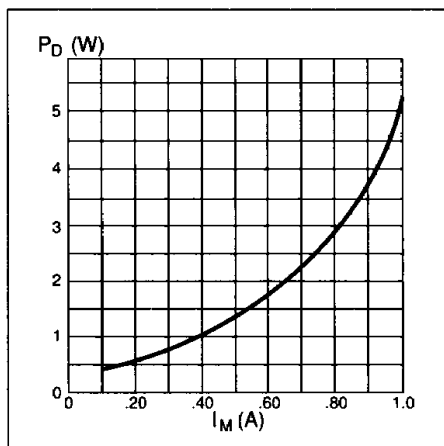

Figure 13. Typical power dissipation vs. motor current.

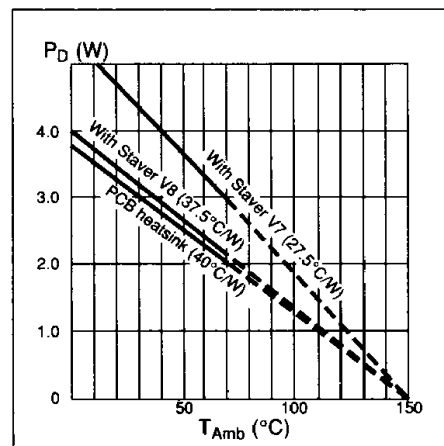

Figure 14. Allowable power dissipation vs. ambient temperature.

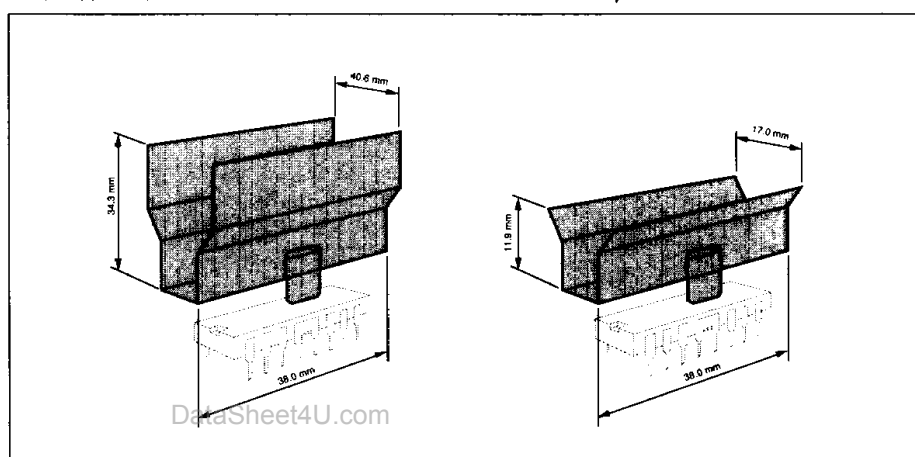

Figure 15. Heatsinks, Staver, type V7 and V8 by Columbia-Staver UK.

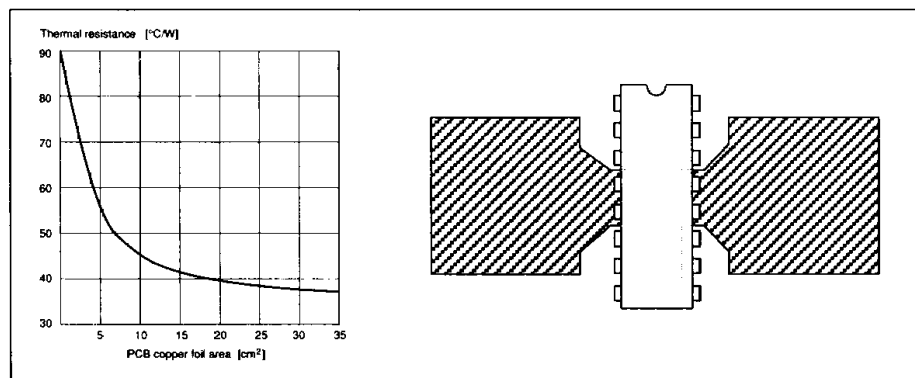

Figure 16. Copper foil used as a heatsink.

Description	DIP	PLCC
$R_{th_{j-c}}$ , Junction to Case (Case = ground pin)	11°C/W	9°C/W
$R_{th_{j-a}}$ , Junction to Ambient*	40°C/W	35°C/W

\* For the DIP, the four ground pins soldered to a 20 cm<sup>2</sup> ground plane according to figure 15. For the PLCC, all ground pins are soldered to a 20 cm<sup>2</sup> ground plane located as close as possible to the device and on both sides of a double sided PCB.

Table 1. Thermal resistance. Thermal resistance values are heavily dependant on location and shape of heatsinks.

T-90-20

**5-lead TO-220**

dim.	millimeters		inches	
	min.	max.	min.	max.
A	3.53	3.91	0.139	0.154
B	9.66	10.66	0.380	0.420
C	3.55	4.80	0.140	0.189
D	1.05	1.39	0.041	0.055
E	2.04	2.92	0.080	0.155
F	0.38	0.50	0.015	0.020
G	2.54	3.05	0.100	0.120
H		3.00		0.118
I	1.50	1.90	0.059	0.075
J	12.50	14.50	0.492	0.571
K	14.32	15.52	0.564	0.611
L	0.81	0.95	0.032	0.037
M	5.85	6.85	0.230	0.270

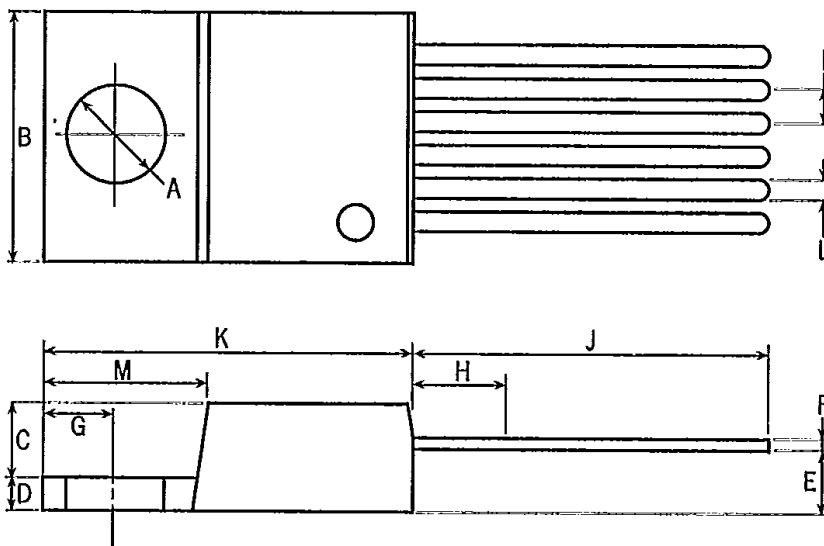
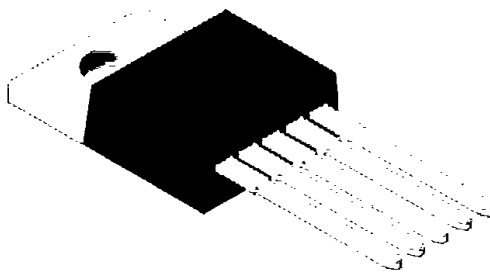

4U.com

DataSheet4U.com

DataSheet

**16-lead small outline package**

dim.	millimeters		inches	
	min.	max.	min.	max.
A	2.35	2.65	0.093	0.104
B	0.33	0.51	0.013	0.020
C	0.23	0.32	0.009	0.012
D	1.27 typical		0.050 typical	
E	7.40	7.60	0.291	0.299
F	10.00	10.65	0.394	0.419
G	0.40	1.27	0.016	0.050
H	10.10	10.50	0.397	0.460
I	0.66		0.026	

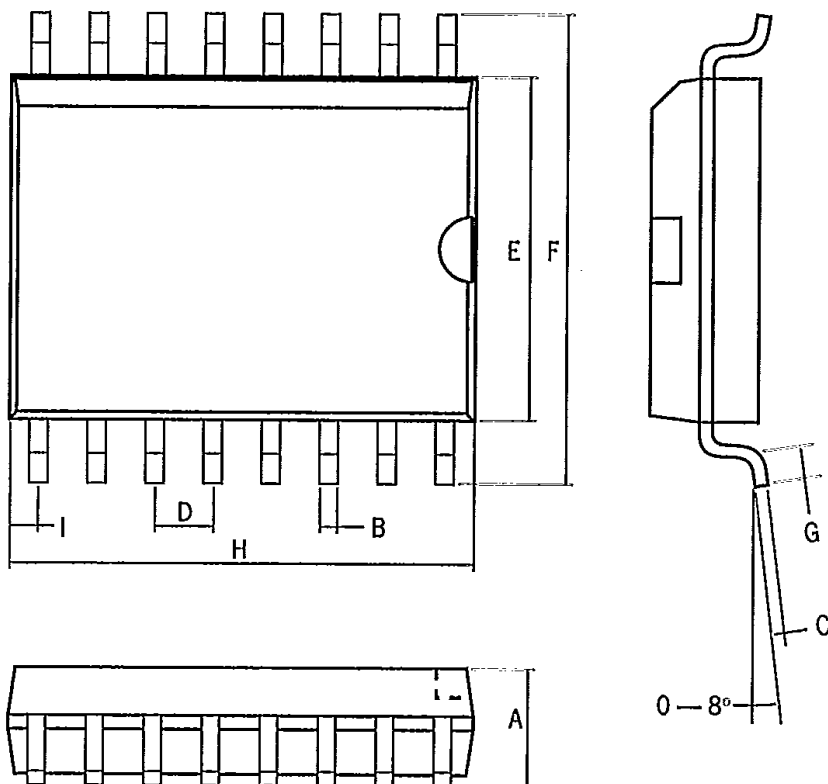
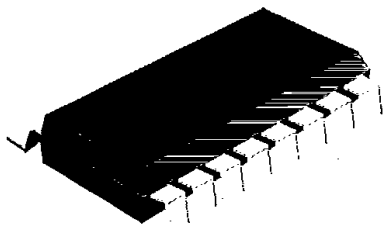

4-2

DataSheet4U.com

www.DataSheet4U.com

DataSheet4U.com

DataSheet4U.com



## 16-pin dual in-line package

dim.	millimeters		inches	
	min.	max.	min.	max.
A	0.39		0.015	
B	0.13		0.005	
C	0.36	0.56	0.014	0.022
D	2.54	typical	0.100	typical
E		5.33		0.210
F	2.93	4.06	0.115	0.160
G	7.62	8.25	0.300	0.325
H	0.20	0.38	0.008	0.015
I	18.93	21.33	0.745	0.840
J	6.10	7.11	0.240	0.280
K	2.93	4.95	0.115	0.195
L		10.92		0.430
M	1.15	1.77	0.045	0.070

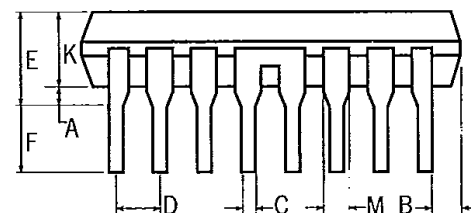
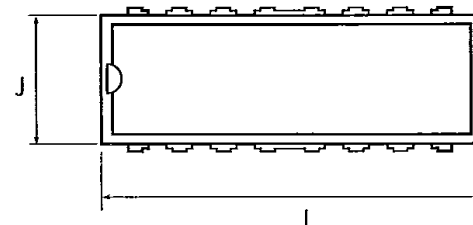
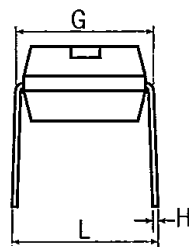
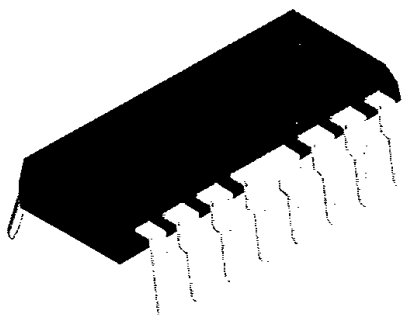
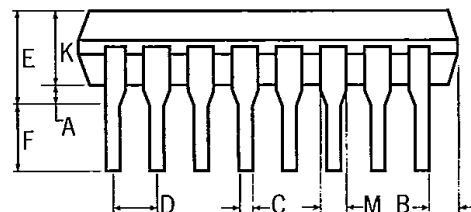
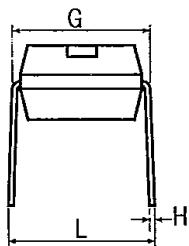
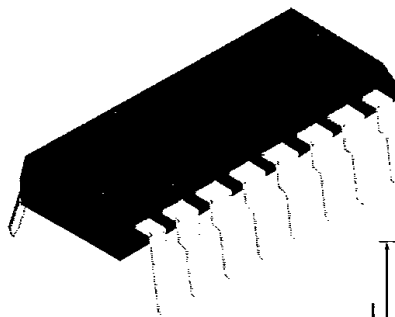

DataSheet4U.com

DataSheet4U.com

DataSheet4U.com

22-pin dual in-line package

T-90-20

dim.	millimeters		inches	
	min.	max.	min.	max.
A	0.39		0.015	
B	0.13		0.005	
C	0.36	0.56	0.014	0.022
D	2.54 typical		0.100 typical	
E		5.33		0.210
F	2.93	4.06	0.115	0.160
G	9.91	10.79	0.390	0.425
H	0.20	0.38	0.008	0.015
I	26.67	28.44	1.050	1.120
J	8.39	9.65	0.330	0.380
K	3.18	4.95	0.125	0.195
L		12.70		0.500
M	0.77	1.77	0.030	0.070
N	0.56	1.17	0.022	0.046

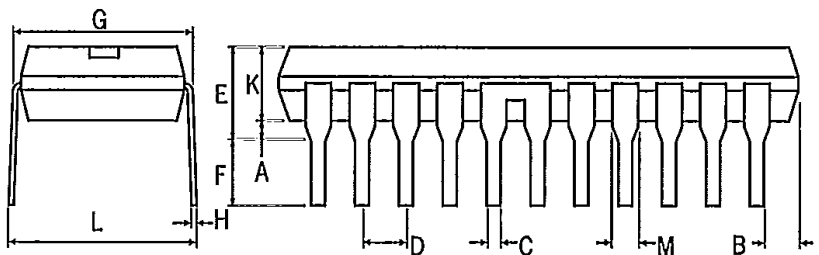
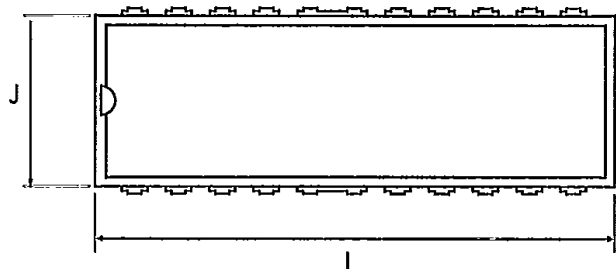
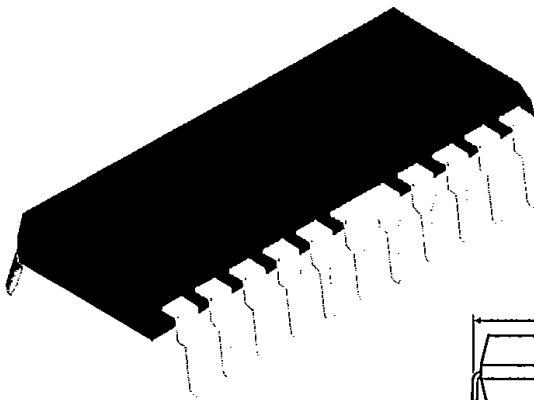
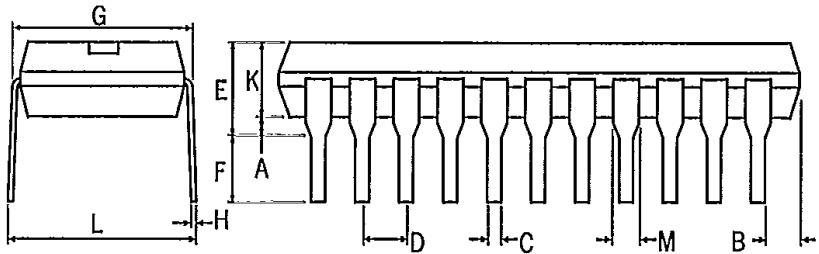
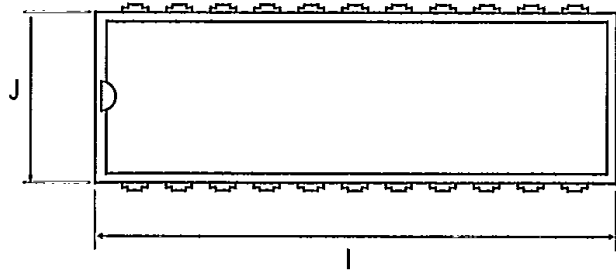
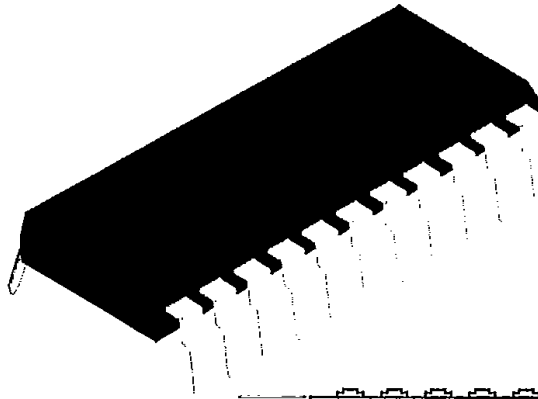

T-90-20

## 24-pin dual in-line package

dim.	millimeters		inches	
	min.	max.	min.	max.
A	0.39		0.015	
B	0.13		0.005	
C	0.36	0.56	0.014	0.022
D	2.54 typical		0.100 typical	
E		5.33		0.210
F	2.93	4.06	0.115	0.160
G	7.62	8.25	0.300	0.325
H	0.20	0.38	0.008	0.015
I	28.60	32.30	1.125	1.275
J	6.10	7.11	0.240	0.280
K	2.93	4.95	0.115	0.195
L		10.92		0.430
M	1.15	1.77	0.045	0.070

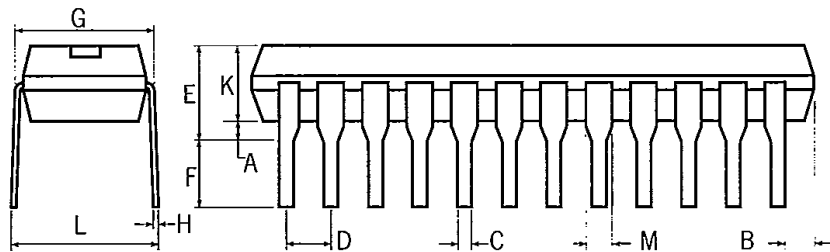
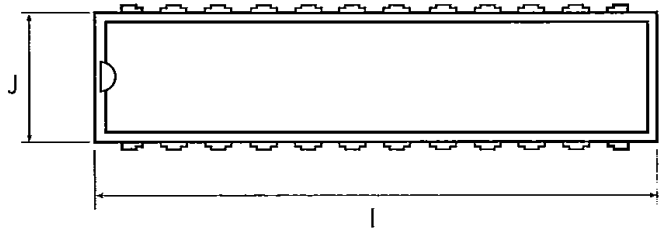
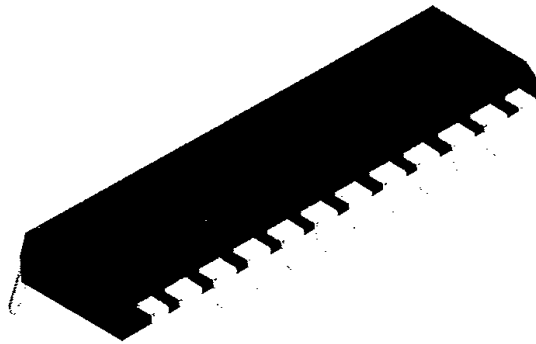

**28-lead PLCC package**

dim.	millimeters		inches	
	min.	max.	min.	max.
A	12.32	12.57	0.485	0.495
B	11.43	11.58	0.450	0.456
C	0.66	0.81	0.026	0.032
D	2.29	3.04	0.090	0.120
E	9.91	10.92	0.390	0.430
F	4.20	4.57	0.165	0.180
G	1.27 typical		0.050 typical	
I	0.51		0.020	
J	0.33	0.53	0.013	0.027

