

SEMITRANS® M IGBT Modules

SKM 75 GB 123 D
SKM 75 GAL 123 D ⁶⁾
SKM 75 GAR 123 D ⁶⁾

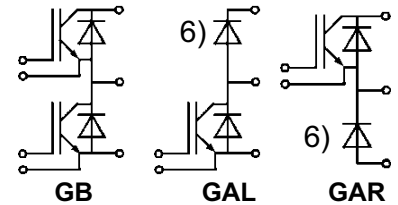

SEMITRANS 2



Features

- MOS input (voltage controlled)
- N channel, Homogeneous Si
- Low inductance case
- Very low tail current with low temperature dependence
- High short circuit capability, self limiting to $6 \cdot I_{cnom}$
- Latch-up free
- Fast & soft inverse CAL diodes⁸⁾
- Isolated copper baseplate using DCB Direct Copper Bonding Technology
- Large clearance (10 mm) and creepage distances (20 mm).

Typical Applications: → B 6 - 91

- Switching (not for linear use)

¹⁾ $T_{case} = 25 \text{ }^\circ\text{C}$, unless otherwise specified

²⁾ $I_F = -I_C$, $V_R = 600 \text{ V}$, $-di_F/dt = 800 \text{ A}/\mu\text{s}$, $V_{GE} = 0 \text{ V}$

³⁾ Use $V_{GEOff} = -5 \dots -15 \text{ V}$

⁵⁾ See fig. 2 + 3; $R_{Goff} = 22 \text{ } \Omega$

⁶⁾ The free-wheeling diodes of the GAL and GAR types have the data of the inverse diodes of SKM 100 GB 123 D

⁸⁾ CAL = Controlled Axial Lifetime Technology.

Cases and mech. data → B6 - 92 SEMITRANS 2

Absolute Maximum Ratings		Values		Units
Symbol	Conditions ¹⁾			
V_{CES}		1200		V
V_{CGR}	$R_{GE} = 20 \text{ k}\Omega$	1200		V
I_C	$T_{case} = 25/80 \text{ }^\circ\text{C}$	75 / 60		A
I_{CM}	$T_{case} = 25/80 \text{ }^\circ\text{C}$; $t_p = 1 \text{ ms}$	150 / 120		A
V_{GES}		± 20		V
P_{tot}	per IGBT, $T_{case} = 25 \text{ }^\circ\text{C}$	460		W
$T_j, (T_{stg})$		- 40 ... +150 (125)		$^\circ\text{C}$
V_{isol}	AC, 1 min.	2 500		V
humidity	IEC 60721-3-3	Class 3K7/IE32		
climate	IEC 68 T.1	40/125/56		
Inverse Diode			FWD ⁶⁾	
$I_F = -I_C$	$T_{case} = 25/80 \text{ }^\circ\text{C}$	75 / 50	95 / 65	A
$I_{FM} = -I_{CM}$	$T_{case} = 25/80 \text{ }^\circ\text{C}$; $t_p = 1 \text{ ms}$	150 / 120	150 / 120	A
I_{FSM}	$t_p = 10 \text{ ms}$; sin.; $T_j = 150 \text{ }^\circ\text{C}$	550	720	A
I^2t	$t_p = 10 \text{ ms}$; $T_j = 150 \text{ }^\circ\text{C}$	1500	2600	A^2s

Characteristics		min.	typ.	max.	Units
Symbol	Conditions ¹⁾				
$V_{(BR)CES}$	$V_{GE} = 0$, $I_C = 4 \text{ mA}$	$\geq V_{CES}$	-	-	V
$V_{GE(th)}$	$V_{GE} = V_{CE}$, $I_C = 2 \text{ mA}$	4,5	5,5	6,5	V
I_{CES}	$V_{GE} = 0$ } $T_j = 25 \text{ }^\circ\text{C}$	-	0,8	1	mA
	$V_{CE} = V_{CES}$ } $T_j = 125 \text{ }^\circ\text{C}$	-	3,5	-	mA
I_{GES}	$V_{GE} = 20 \text{ V}$, $V_{CE} = 0$	-	-	200	nA
V_{CESat}	$I_C = 50 \text{ A}$ } $V_{GE} = 15 \text{ V}$;	-	2,5(3,1)	3(3,7)	V
V_{CESat}	$I_C = 75 \text{ A}$ } $T_j = 25 (125) \text{ }^\circ\text{C}$	-	3(3,8)	-	V
g_{fs}	$V_{CE} = 20 \text{ V}$, $I_C = 50 \text{ A}$	23	40	-	S
C_{CHC}	per IGBT	-	-	350	pF
C_{ies}	$V_{GE} = 0$	-	3,3	4,3	nF
C_{oes}	$V_{CE} = 25 \text{ V}$	-	500	600	pF
C_{res}	$f = 1 \text{ MHz}$	-	220	300	pF
L_{CE}		-	-	30	nH
$t_{d(on)}$	$V_{CC} = 600 \text{ V}$	-	44	100	ns
t_r	$V_{GE} = +15 \text{ V}$, $-15 \text{ V}^3)$	-	56	100	ns
$t_{d(off)}$	$I_C = 50 \text{ A}$, ind. load	-	380	500	ns
t_f	$R_{Gon} = R_{Goff} = 22 \text{ } \Omega$	-	70	100	ns
$E_{on}^5)$	$T_j = 125 \text{ }^\circ\text{C}$	-	8	-	mWs
$E_{off}^5)$		-	5	-	mWs
Inverse Diode ⁸⁾					
$V_F = V_{EC}$	$I_F = 50 \text{ A}$ } $V_{GE} = 0 \text{ V}$;	-	2,0(1,8)	2,5	V
$V_F = V_{EC}$	$I_F = 75 \text{ A}$ } $T_j = 25 (125) \text{ }^\circ\text{C}$	-	2,25 (2,1)	-	V
V_{TO}	$T_j = 125 \text{ }^\circ\text{C}$	-	-	1,2	V
r_T	$T_j = 125 \text{ }^\circ\text{C}$	-	18	22	m Ω
I_{RRM}	$I_F = 50 \text{ A}$; $T_j = 25 (125) \text{ }^\circ\text{C}^2)$	-	23(35)	-	A
Q_{rr}	$I_F = 50 \text{ A}$; $T_j = 25 (125) \text{ }^\circ\text{C}^2)$	-	2,3(7)	-	μC
FWD of types "GAL" and "GAR" ⁸⁾					
$V_F = V_{EC}$	$I_F = 50 \text{ A}$ } $V_{GE} = 0 \text{ V}$;	-	1,85(1,6)	2,2	V
$V_F = V_{EC}$	$I_F = 75 \text{ A}$ } $T_j = 25 (125) \text{ }^\circ\text{C}$	-	2,0(1,8)	-	V
V_{TO}	$T_j = 125 \text{ }^\circ\text{C}$	-	-	1,2	V
r_T	$T_j = 125 \text{ }^\circ\text{C}$	-	12	15	m Ω
I_{RRM}	$I_F = 50 \text{ A}$; $T_j = 25 (125) \text{ }^\circ\text{C}^2)$	-	27(40)	-	A
Q_{rr}	$I_F = 50 \text{ A}$; $T_j = 25 (125) \text{ }^\circ\text{C}^2)$	-	2,5(8)	-	μC
Thermal Characteristics					
R_{thjc}	per IGBT	-	-	0,27	$^\circ\text{C}/\text{W}$
R_{thjc}	per diode / FWD "GAL"	-	-	0,60/0,50	$^\circ\text{C}/\text{W}$
R_{thch}	per module	-	-	0,05	$^\circ\text{C}/\text{W}$

SKM 75 GB 123 D ...

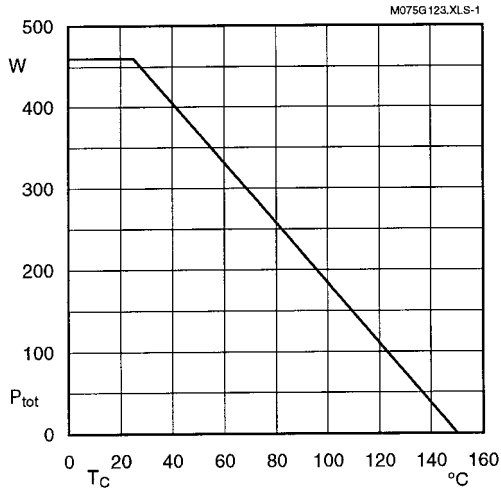

Fig. 1 Rated power dissipation $P_{tot} = f(T_C)$

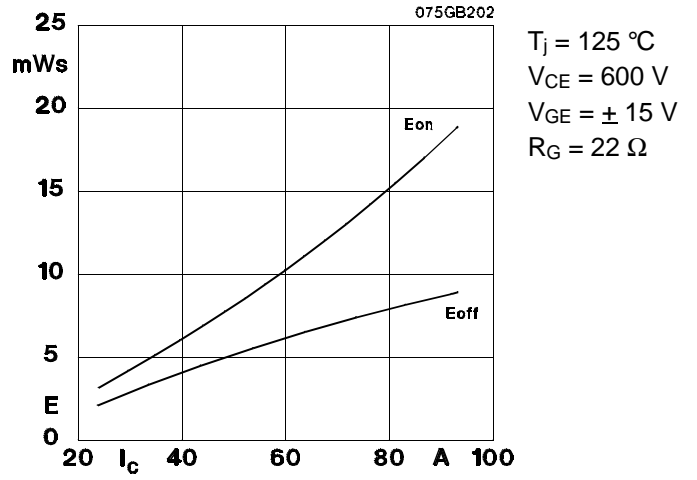

Fig. 2 Turn-on /-off energy $= f(I_C)$

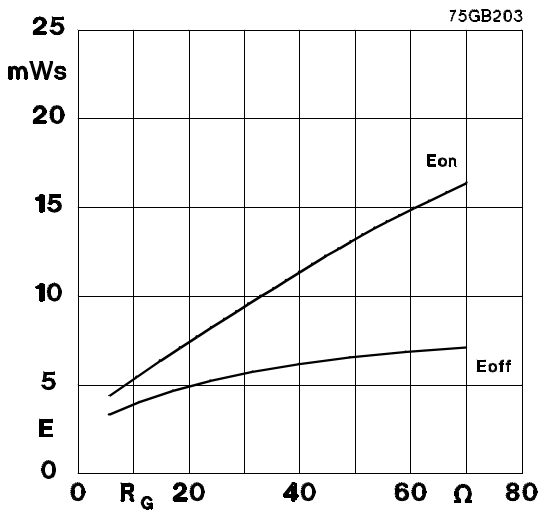

Fig. 3 Turn-on /-off energy $= f(R_G)$

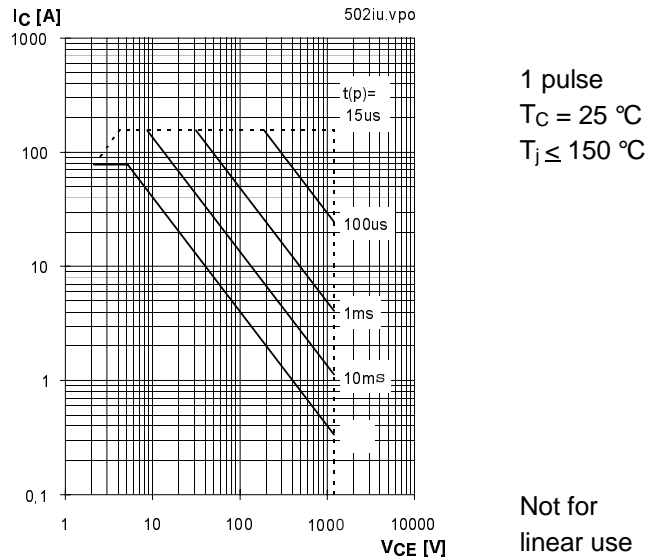

Fig. 4 Maximum safe operating area (SOA) $I_C = f(V_{CE})$

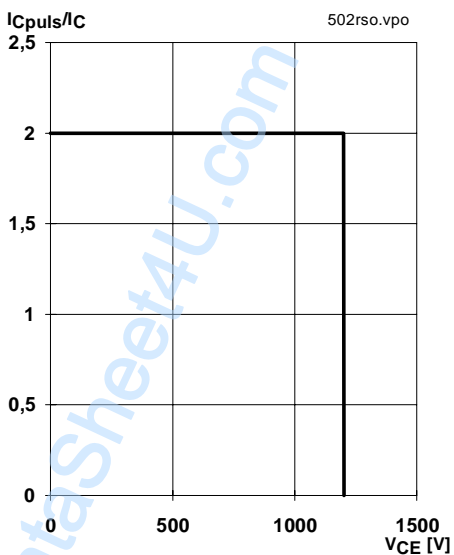

Fig. 5 Turn-off safe operating area (RBSOA)

$T_j \leq 150\text{ }^\circ\text{C}$
 $V_{GE} = 15\text{ V}$
 $R_{Goff} = 22\text{ }\Omega$
 $I_C = 50\text{ A}$

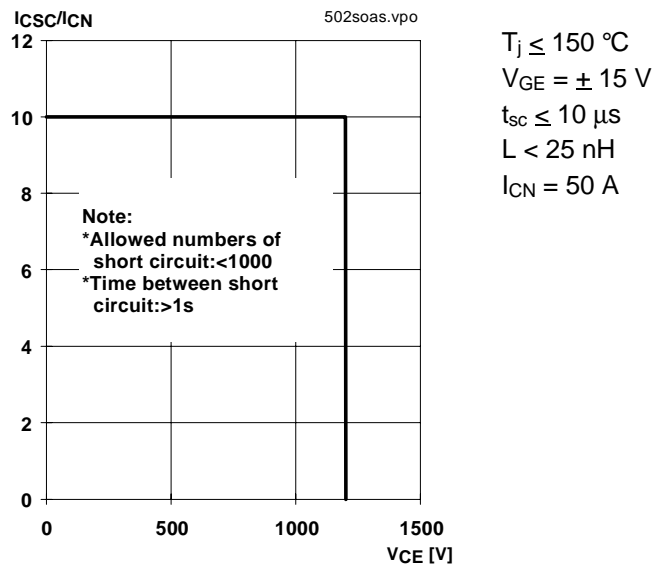

Fig. 6 Safe operating area at short circuit $I_C = f(V_{CE})$

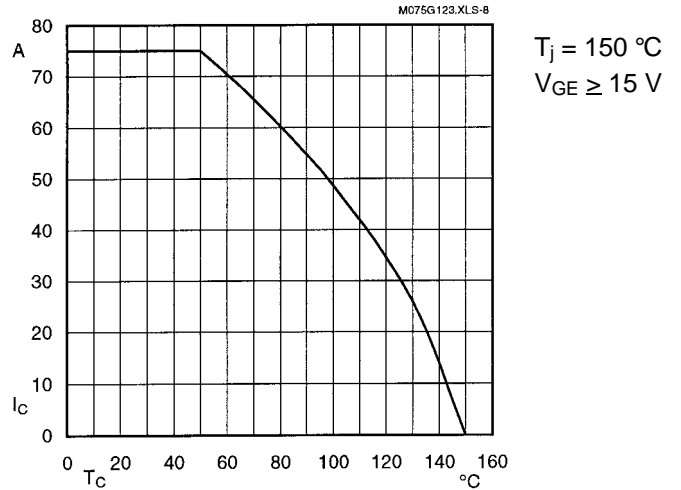

Fig. 8 Rated current vs. temperature $I_c = f(T_c)$

Fig. 7 Short circuit current vs. turn-on gate voltage

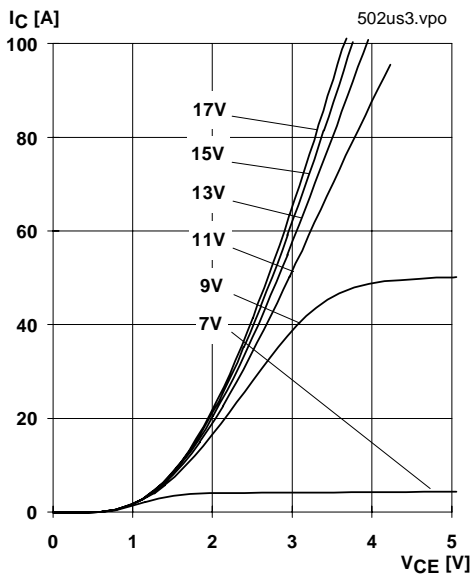

Fig. 9 Typ. output characteristic, $t_p = 80 \mu s$; $25 \text{ }^\circ\text{C}$

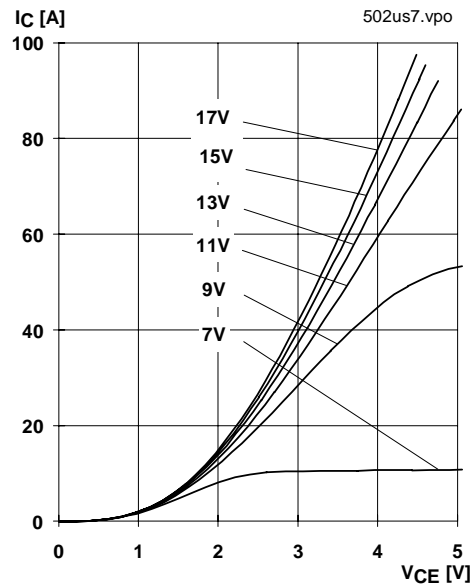

Fig. 10 Typ. output characteristic, $t_p = 80 \mu s$; $125 \text{ }^\circ\text{C}$

$$P_{cond(t)} = V_{CEsat(t)} \cdot I_{C(t)}$$

$$V_{CEsat(t)} = V_{CE(TO)(T_j)} + r_{CE(T_j)} \cdot I_{C(t)}$$

$$V_{CE(TO)(T_j)} \leq 1,5 + 0,002 (T_j - 25) \text{ [V]}$$

$$\text{typ.: } r_{CE(T_j)} = 0,020 + 0,00008 (T_j - 25) \text{ [\Omega]}$$

$$\text{max.: } r_{CE(T_j)} = 0,030 + 0,00010 (T_j - 25) \text{ [\Omega]}$$

$$\text{valid for } V_{GE} = +15 \frac{+2}{-1} \text{ [V]; } I_C \geq 0,3 I_{Cnom}$$

Fig. 11 Saturation characteristic (IGBT)
Calculation elements and equations

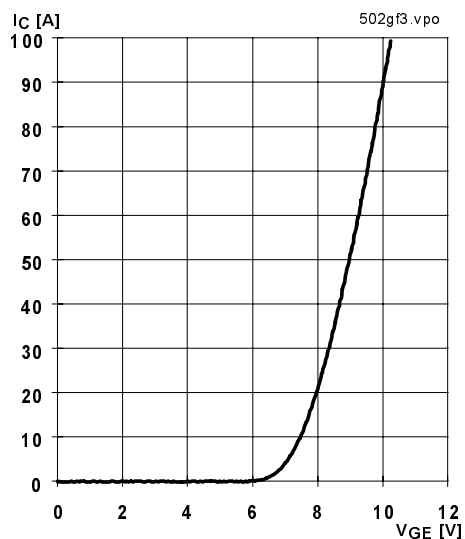

Fig. 12 Typ. transfer characteristic, $t_p = 80 \mu s$; $V_{CE} = 20 \text{ V}$

SKM 75 GB 123 D ...

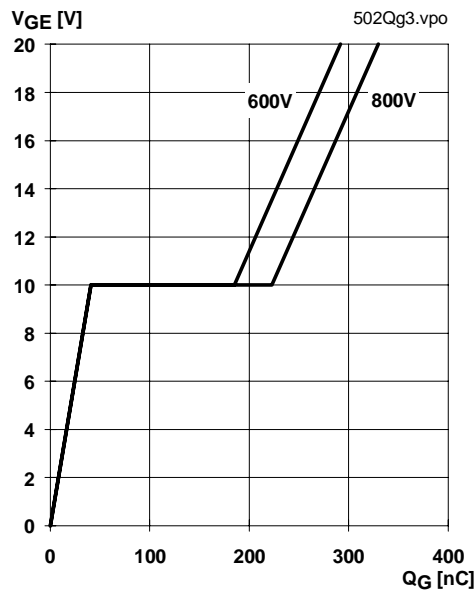

Fig. 13 Typ. gate charge characteristic

$I_{Cpuls} = 50 \text{ A}$

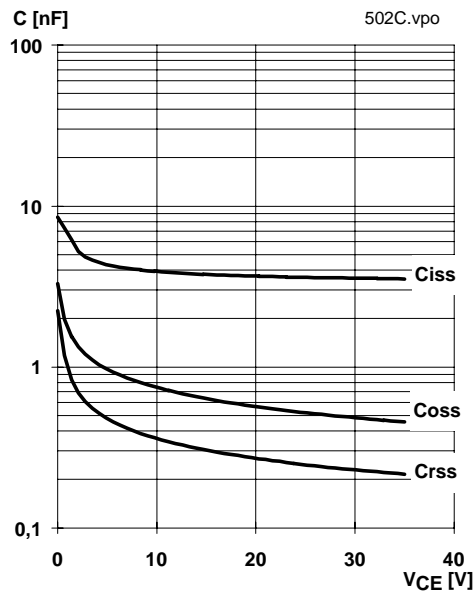

Fig. 14 Typ. capacitances vs. V_{CE}

$V_{GE} = 0 \text{ V}$
 $f = 1 \text{ MHz}$

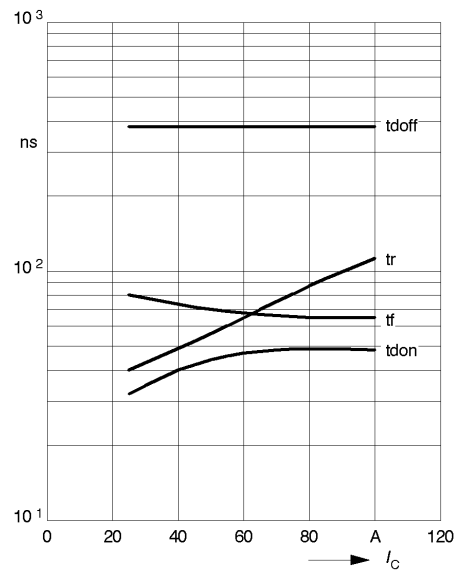

Fig. 15 Typ. switching times vs. I_C

$T_j = 125 \text{ }^\circ\text{C}$
 $V_{CE} = 600 \text{ V}$
 $V_{GE} = \pm 15 \text{ V}$
 $R_{Gon} = 22 \text{ } \Omega$
 $R_{Goff} = 22 \text{ } \Omega$
induct. load

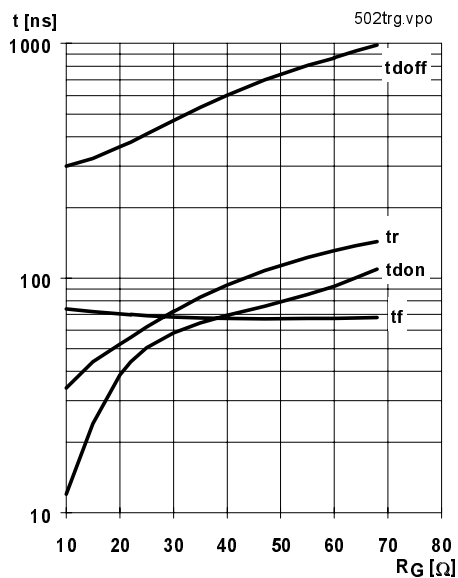

Fig. 16 Typ. switching times vs. gate resistor R_G

$T_j = 125 \text{ }^\circ\text{C}$
 $V_{CE} = 600 \text{ V}$
 $V_{GE} = \pm 15 \text{ V}$
 $I_C = 50 \text{ A}$
induct. load

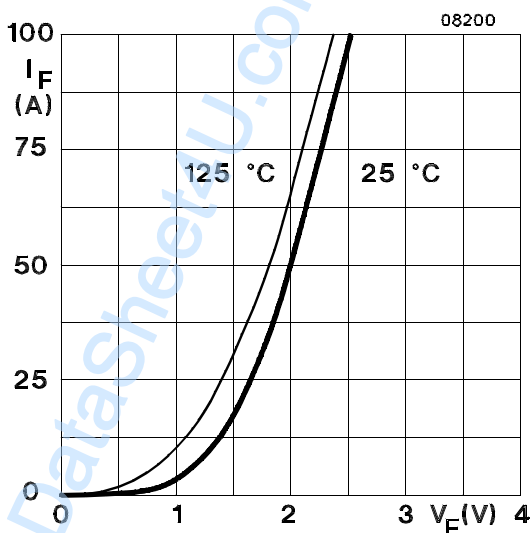

Fig. 17 Typ. CAL diode forward characteristic

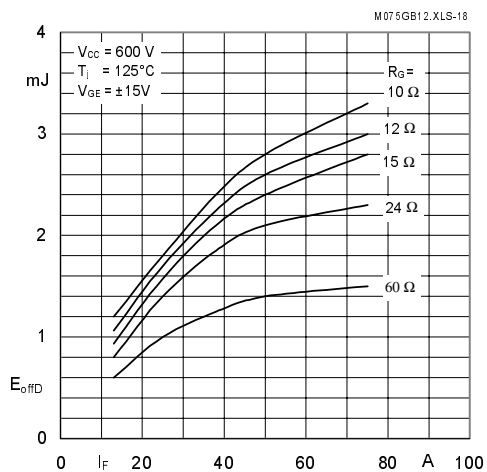

Fig. 18 Diode turn-off energy dissipation per pulse

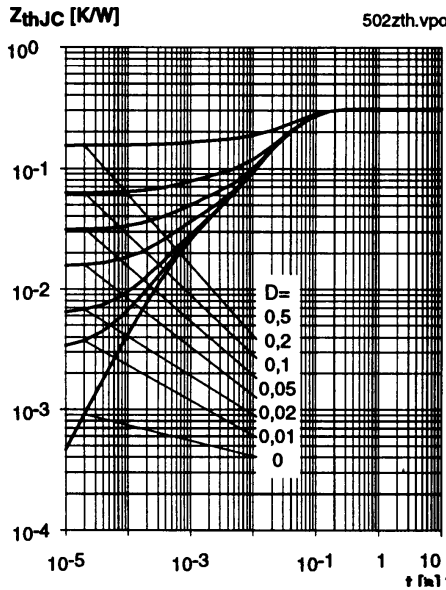

Fig. 19 Transient thermal impedance of IGBT
 $Z_{thJC} = f(t_p)$; $D = t_p / t_c = t_p \cdot f$

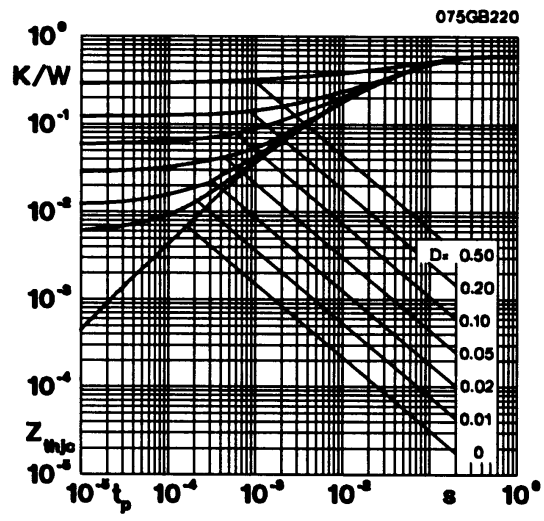

Fig. 20 Transient thermal impedance of inverse CAL diodes
 $Z_{thJC} = f(t_p)$; $D = t_p / t_c = t_p \cdot f$

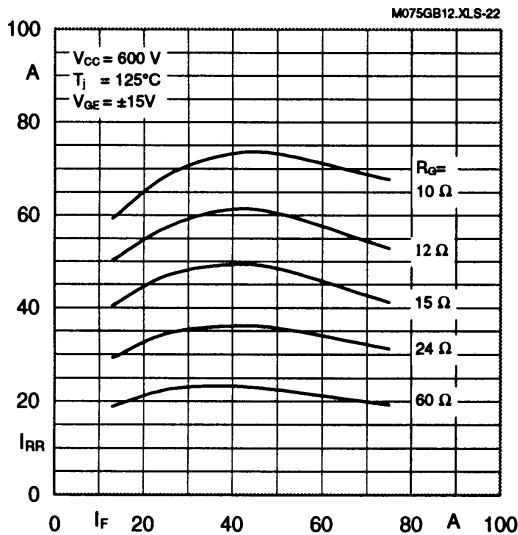

Fig. 22 Typ. CAL diode peak reverse recovery current $I_{RR} = f(I_F, R_G)$

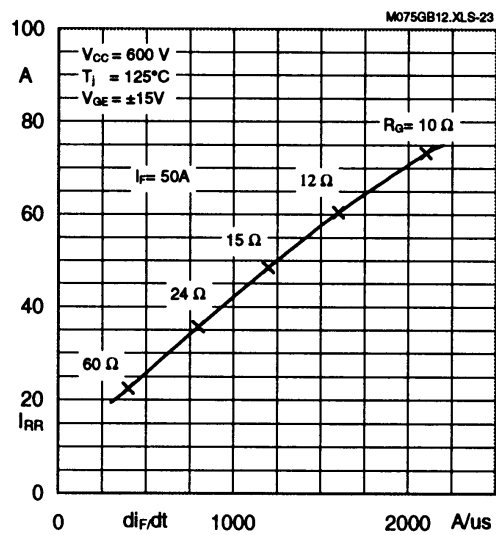

Fig. 23 Typ. CAL diode peak reverse recovery current $I_{RR} = f(di/dt)$

Typical Applications

Include

- Switched mode power supplies
- DC servo and robot drives
- Inverters
- DC choppers (versions GAL)
- AC motor speed control
- Inductive heating
- UPS Uninterruptable power supplies
- General power switching applications
- Electronic (also portable) welders
- Pulse frequencies also above 15 kHz

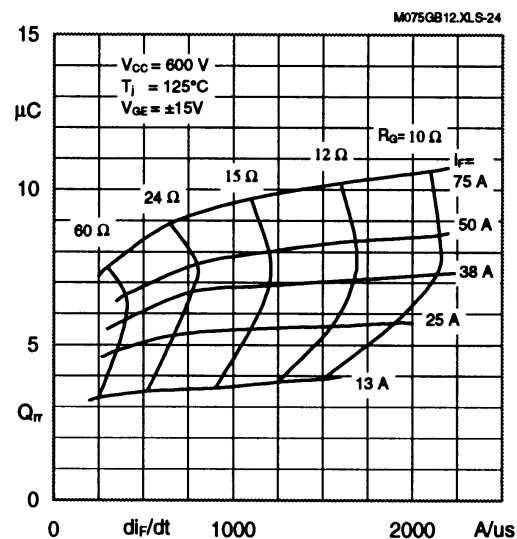

Fig. 24 Typ. CAL diode recovered charge $Q_{rr} = f(di/dt)$

SKM 75 GB 123 D ...

SEMITRANS 2

CASED61

Case D 61

UL Recognized

File no. E 63 532

SKM 75 GB 123 D

SKM 75 GB 173 D

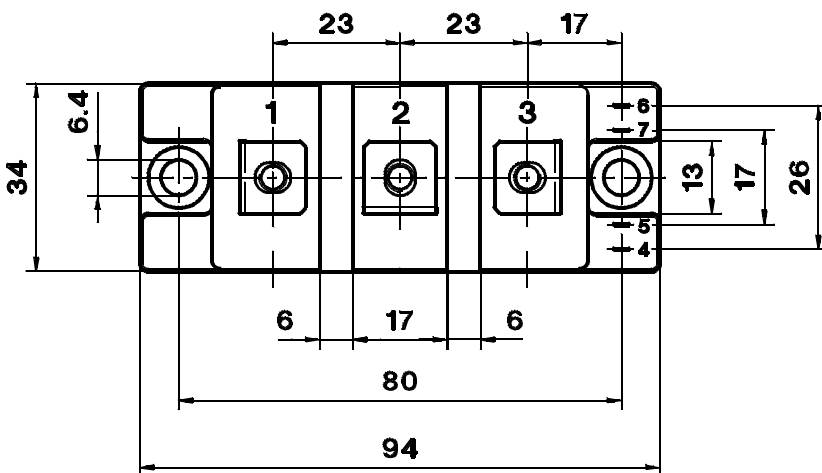
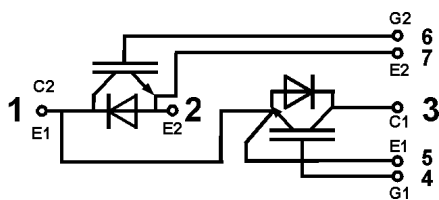
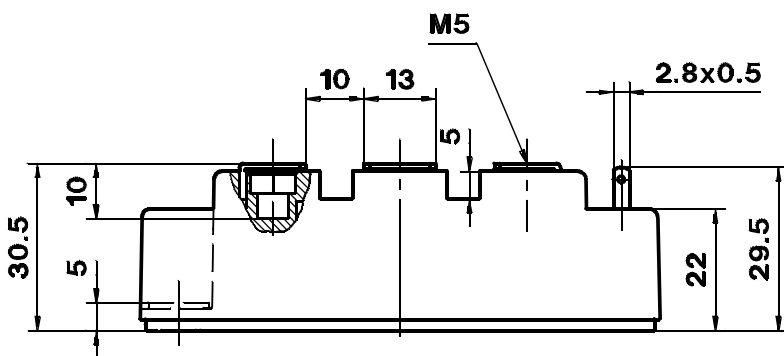

Dimensions in mm

SKM 75 GAL 123 D

Case D 62 (→ D 61)

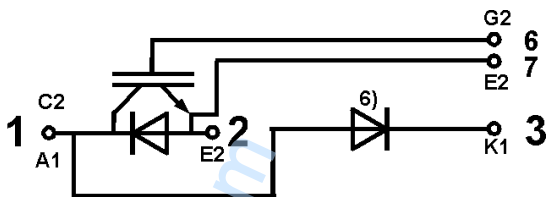

SKM 75 GAR 123 D

Case D 63 (→ D 61)

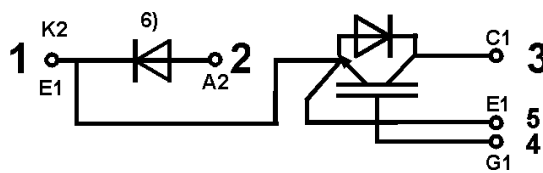

Case outline and circuit diagrams

Mechanical Data		Values			Units
Symbol	Conditions	min.	typ.	max.	
M ₁	to heatsink, SI Units (M6)	3	—	5	Nm
	to heatsink, US Units	27	—	44	lb.in.
M ₂	for terminals, SI Units (M5)	2,5	—	5	Nm
	for terminals US Units	22	—	44	lb.in.
a		—	—	5x9,81	m/s ²
w		—	—	160	g

This is an electrostatic discharge sensitive device (ESDS). Please observe the international standard IEC 747-1, Chapter IX.

Eight devices are supplied in one SEMIBOX A without mounting hardware, which can be ordered separately under Ident No. 33321100 (for 10 SEMITRANS 2)
 Accessories → B 6 – 4.
 SEMIBOX → C – 1.
 Larger packing units of 20 pieces are used if suitable.

⁶⁾ Freewheeling diode → B 6 – 87, remark 6.