

STR7000+SI-8020 Series

Separate Excitation Switching Type

■Features

- High output current (6A:STR7000 series, 12A: STR7100 series)
- High efficiency (70 to 90%)
- Wide DC input voltage range
- Built-in drooping type overcurrent protection circuit
- Foldback type overcurrent protection can be set externally.
- Output voltage adjustment
- Built-in reference oscillator (35kHz)
- Output ON/OFF control

■Applications

- Electronic equipment

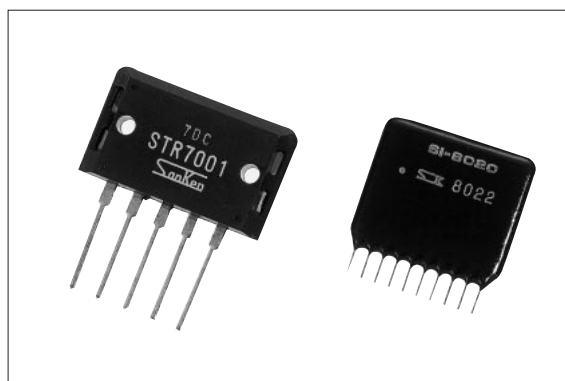

■Lineup

I_o (A) \ V_o (V)	5	12	15	24
6	STR7001+SI-8020	STR7002+SI-8021	STR7002+SI-8022	STR7003+SI-8023
12	STR7101+SI-8020	STR7102+SI-8021	STR7102+SI-8022	STR7103+SI-8023

DataSheet4U.com

■Absolute Maximum Ratings

Power Section: STR7000/STR7100 ($T_a=25^\circ\text{C}$)

Parameter	Symbol	Ratings		Unit
		STR7000 Series	STR7100 Series	
Power Transistor Breakdown Voltage	V_{4-1}	60		V
Drive Transistor Breakdown Voltage	V_{4-5}	60		V
Diode Breakdown Voltage	V_{1-2}	60		V
Collector Current	I_C	6(peak 7.5)	12(peak 15)	A
Power Dissipation	P_{D1}	100($T_c=25^\circ\text{C}$)	125($T_c=25^\circ\text{C}$)	W
	P_{D2}	4.3(Without heatsink)		W
Power Transistor Thermal Resistance	$R_{th(j-c)}$	1.25	1.0	$^\circ\text{C}/\text{W}$
Power Transistor Junction Temperature	T_j	+150		$^\circ\text{C}$
Operating Temperature	T_{OP}	-30 to +125(T_c)		$^\circ\text{C}$
Storage Temperature	T_{Stg}	-30 to +125		$^\circ\text{C}$

■Control Section: SI-8020 Series ($T_a=25^\circ\text{C}$)

Parameter	Symbol	Ratings	Unit
DC Input Voltage	V_{IN}	55	V
Power Dissipation	P_D	1	W
Operating Temperature	T_{OP}	-20 to +85	$^\circ\text{C}$
Storage Temperature	T_{Stg}	-20 to +100	$^\circ\text{C}$

■Electrical Characteristics: 6A Type

(Ta=25°C)

Parameter	Symbol	Ratings												Unit
		STR7001+SI-8020			STR7002+SI-8021			STR7002+SI-8022			STR7003+SI-8023			
		min.	typ.	max.	min.	typ.	max.	min.	typ.	max.	min.	typ.	max.	
DC Input Voltage Range	V _{IN}	11		40	18		50	21		50	30		50	V
Output Voltage	V _O	5.0	5.1	5.2	11.8	12.0	12.2	14.8	15.0	15.2	23.7	24.0	24.3	V
	Conditions	V _{IN} =20V, I _O =3.0A			V _{IN} =27V, I _O =3.0A			V _{IN} =30V, I _O =3.0A			V _{IN} =40V, I _O =3.0A			
Efficiency	η		72			84			86			90		%
	Conditions	V _{IN} =20V, I _O =3.0A			V _{IN} =27V, I _O =3.0A			V _{IN} =30V, I _O =3.0A			V _{IN} =40V, I _O =3.0A			
Switching Frequency	f		35			35			35			35		kHz
	Conditions	V _{IN} =20V, I _O =3.0A			V _{IN} =27V, I _O =3.0A			V _{IN} =30V, I _O =3.0A			V _{IN} =40V, I _O =3.0A			
Line Regulation	ΔV _{OLINE}			80			120			150			200	mV
	Conditions	V _{IN} =15 to 25V, I _O =3.0A			V _{IN} =22 to 32V, I _O =3.0A			V _{IN} =25 to 35V, I _O =3.0A			V _{IN} =35 to 45V, I _O =3.0A			
Load Regulation	ΔV _{OLOAD}			30			40			40			50	mV
	Conditions	V _{IN} =20V, I _O =1 to 5A			V _{IN} =27V, I _O =1 to 5A			V _{IN} =30V, I _O =1 to 5A			V _{IN} =40V, I _O =1 to 5A			
Ripple Rejection	R _{REJ}		45			45			45			45		dB
	Conditions	f=100 to 120Hz			f=100 to 120Hz			f=100 to 120Hz			f=100 to 120Hz			
Overcurrent Protection Starting Current	I _{S1}	6.0		7.5	6.0		7.5	6.0		7.5	6.0		7.5	A
Limited Current at Overcurrent Protection Operation	I _{S2}	6.0		7.5	6.0		7.5	6.0		7.5	6.0		7.5	A
	Conditions	R _S =0.02Ω			R _S =0.02Ω			R _S =0.02Ω			R _S =0.02Ω			

■Electrical Characteristics: 12A Type

(Ta=25°C)

Parameter	Symbol	Ratings												Unit
		STR7101+SI-8020			STR7102+SI-8021			STR7102+SI-8022			STR7103+SI-8023			
		min.	typ.	max.	min.	typ.	max.	min.	typ.	max.	min.	typ.	max.	
DC Input Voltage Range	V _{IN}	11		40	18		50	21		50	30		50	V
Output Voltage	V _O	5.0	5.1	5.2	11.8	12.0	12.2	14.8	15.0	15.2	23.7	24.0	24.3	V
	Conditions	V _{IN} =20V, I _O =6.0A			V _{IN} =27V, I _O =6.0A			V _{IN} =30V, I _O =6.0A			V _{IN} =40V, I _O =6.0A			
Efficiency	η		70			82			84			87		%
	Conditions	V _{IN} =20V, I _O =6.0A			V _{IN} =27V, I _O =6.0A			V _{IN} =30V, I _O =6.0A			V _{IN} =40V, I _O =6.0A			
Switching Frequency	f		35			35			35			35		kHz
	Conditions	V _{IN} =20V, I _O =6.0A			V _{IN} =27V, I _O =6.0A			V _{IN} =30V, I _O =6.0A			V _{IN} =40V, I _O =6.0A			
Line Regulation	ΔV _{OLINE}			80			120			150			200	mV
	Conditions	V _{IN} =15 to 25V, I _O =6.0A			V _{IN} =22 to 32V, I _O =6.0A			V _{IN} =25 to 35V, I _O =6.0A			V _{IN} =35 to 45V, I _O =6.0A			
Load Regulation	ΔV _{OLOAD}			30			40			40			50	mV
	Conditions	V _{IN} =20V, I _O =3 to 9A			V _{IN} =27V, I _O =3 to 9A			V _{IN} =30V, I _O =3 to 9A			V _{IN} =40V, I _O =3 to 9A			
Ripple Rejection	R _{REJ}		45			45			45			45		dB
	Conditions	f=100 to 120Hz			f=100 to 120Hz			f=100 to 120Hz			f=100 to 120Hz			
Overcurrent Protection Starting Current	I _{S1}	12		15	12		15	12		15	12		15	A
Limited Current at Overcurrent Protection Operation	I _{S2}	12		15	12		15	12		15	12		15	A
	Conditions	R _S =0.01Ω			R _S =0.01Ω			R _S =0.01Ω			R _S =0.01Ω			

●STR7000+SI-8020 Series

■Outline Drawing

(unit: mm)

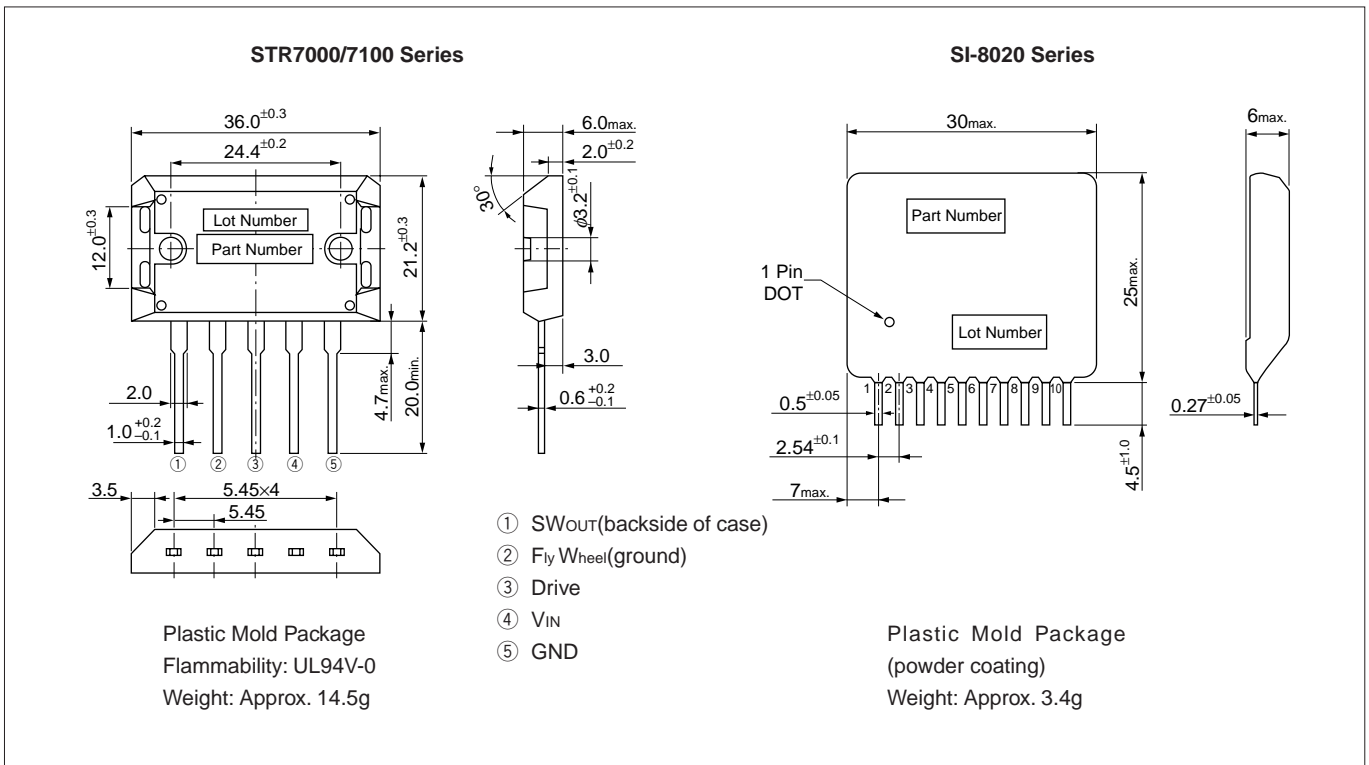

■Block Diagram

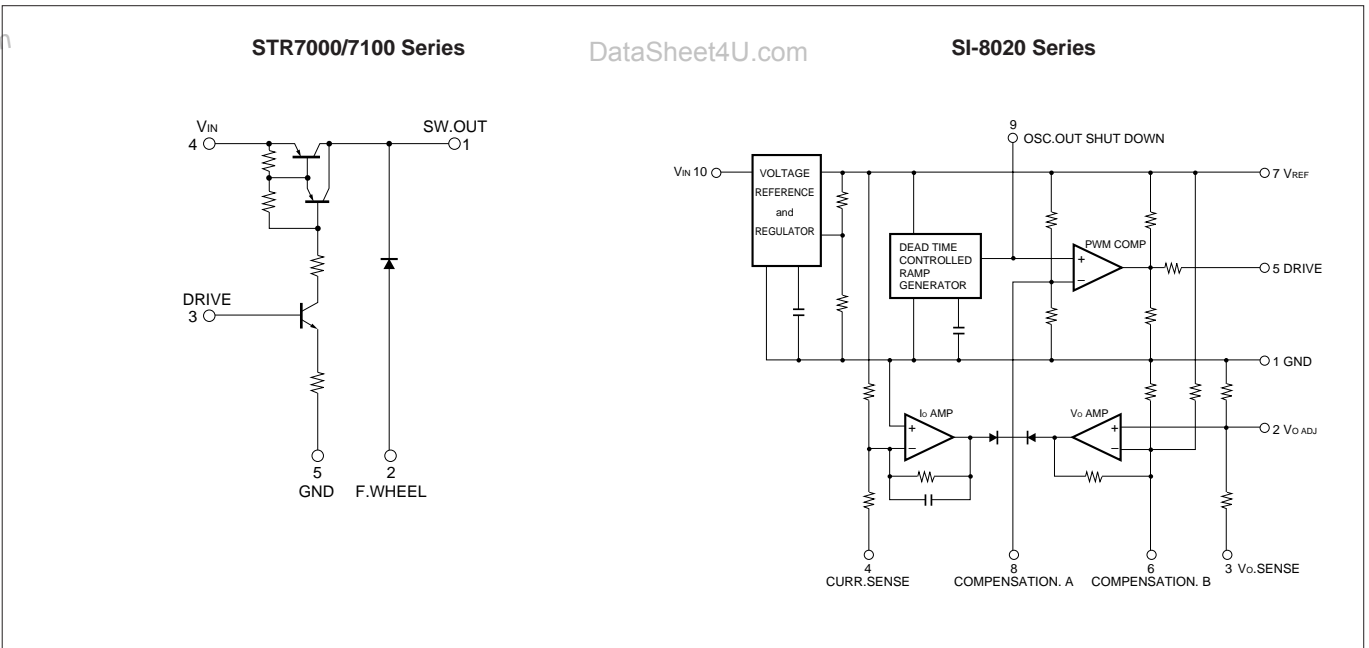

Standard External Circuit

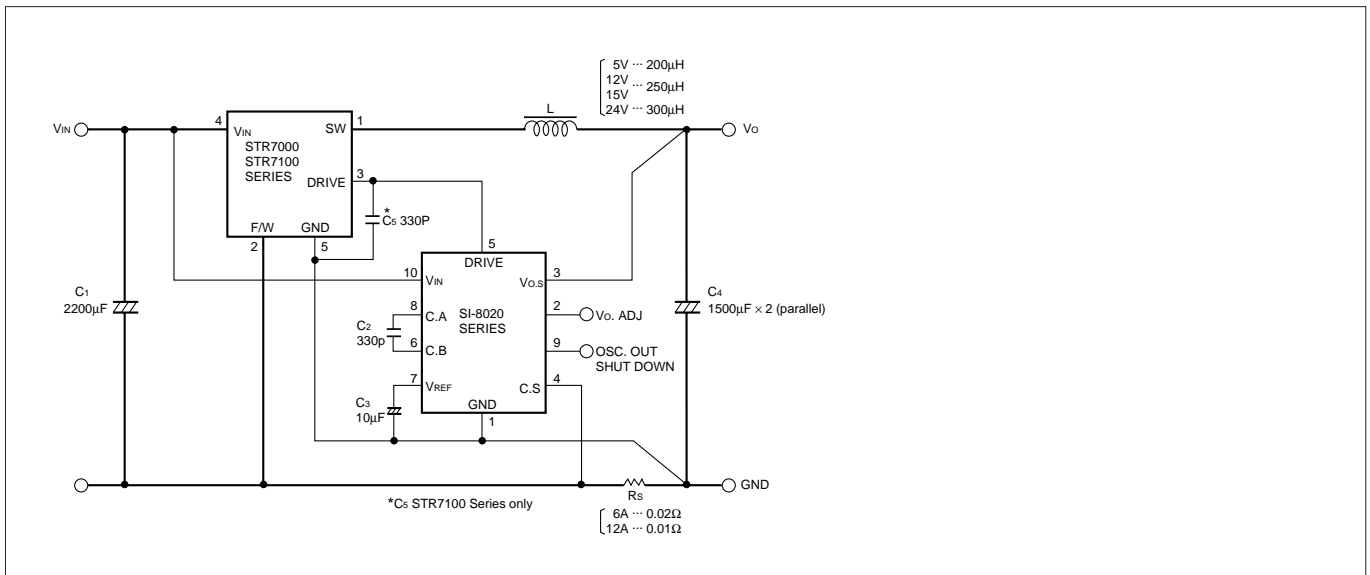

Notes of Pattern Design

- 1) Thick lines in the Standard External Circuit are lines through which a large current flows. Make these pattern lines as thick as possible.
- 2) Place capacitor C₁ on the input side as closely as possible to terminals no.2 and no.4 of the STR7000/7100 series. C₁ may be used in combination with a smoothing capacitor for rectifying, but the above points must be taken into consideration. In cases where C₁ is not provided or it is placed too far from the terminals stated above, abnormal oscillation due to poorer transient response or increased ringing may occur.
- 3) Connect voltage sensing terminal V_{O.S} and GND as closely as possible to output capacitor C₄ (a current of approximately 1mA flows into the V_{O.S} terminal). If they are placed too far from C₄, abnormal oscillation due to decreased regulation or increased switching ripple may occur.
- 4) Connect current sensing terminal C.S and GND as closely as possible to the detection resistor R_s (a current of approximately 0.5mA flows from the CS terminal).

If they are placed too far from R_s, a decrease of the overcurrent setting point due to the voltage drop in the pattern, or malfunction of the protection circuit due to increased ringing may occur.

T_a-P_d Characteristics

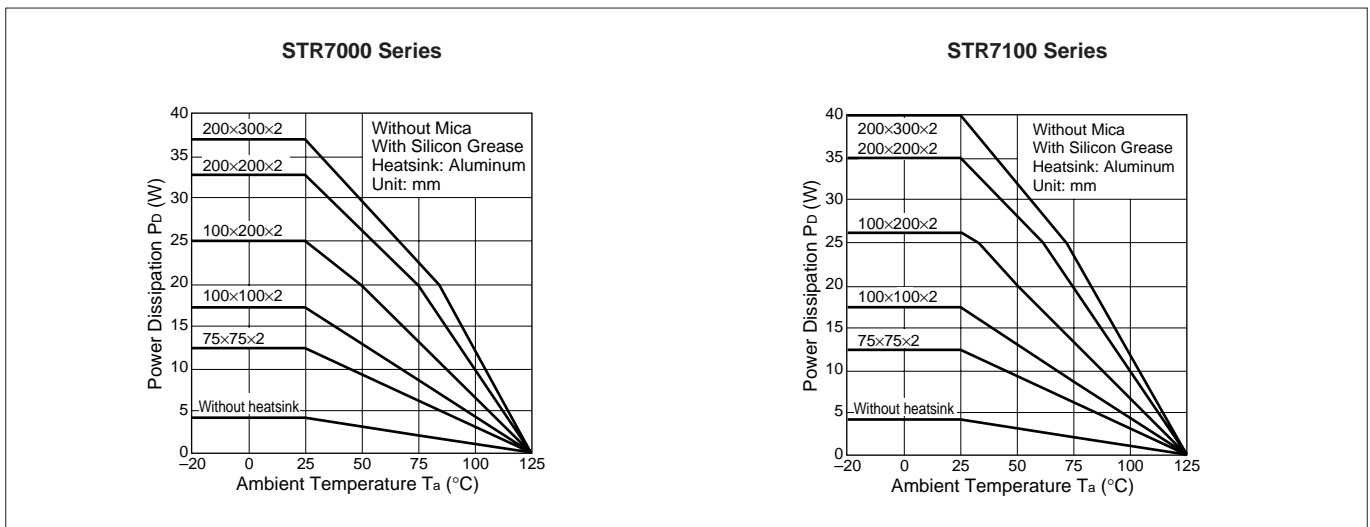

Typical Characteristics

($T_a=25^{\circ}\text{C}$)

STR7001+SI-8020(5V)

Rise Characteristics

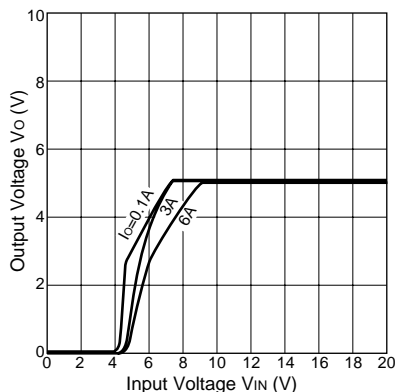

Efficiency Characteristics

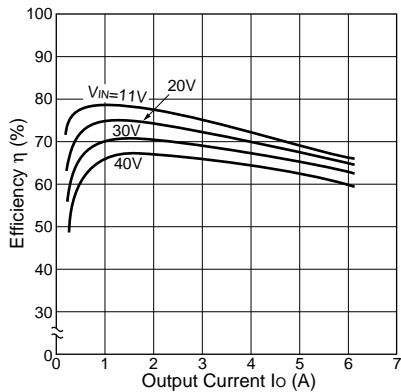

STR7002+SI-8021(12V)

Rise Characteristics

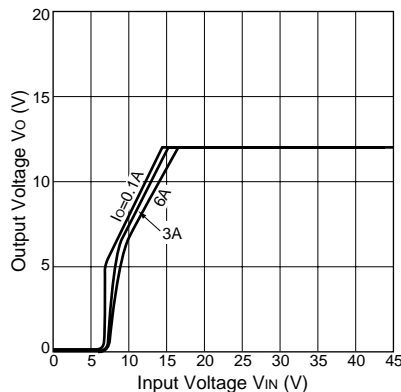

Efficiency Characteristics

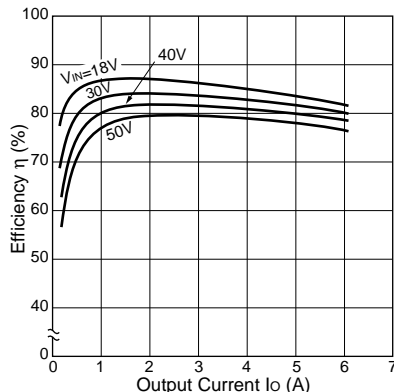

STR7003+SI-8023(24V)

Rise Characteristics

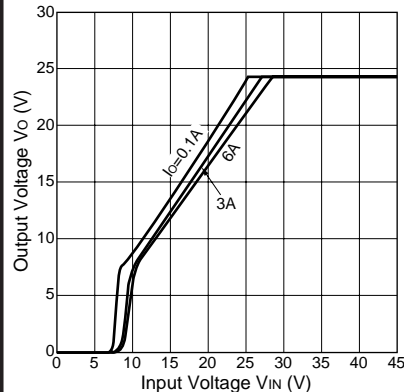

Efficiency Characteristics

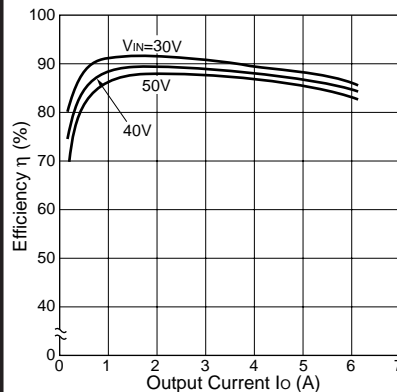

STR7101+SI-8020(5V)

Rise Characteristics

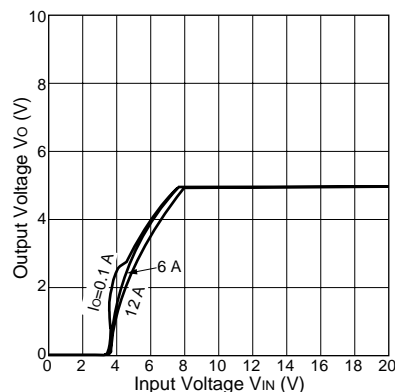

Efficiency Characteristics

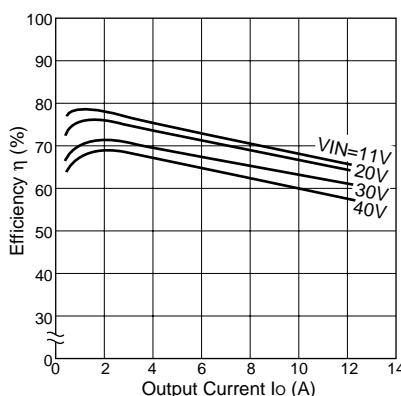

STR7102+SI-8021(12V)

Rise Characteristics

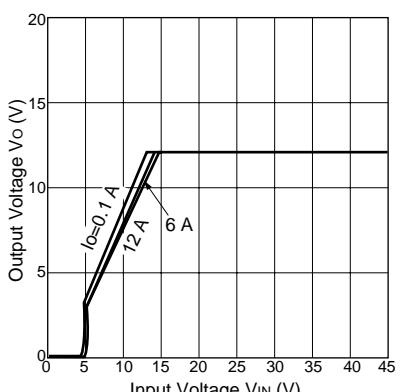

Efficiency Characteristics

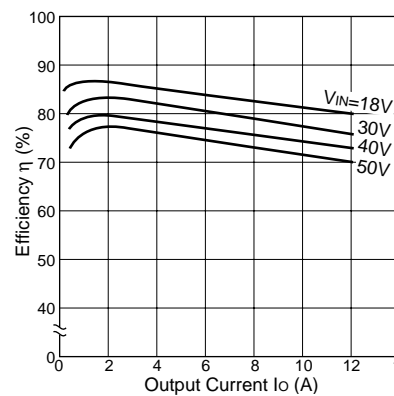

STR7103+SI-8023(24V)

Rise Characteristics

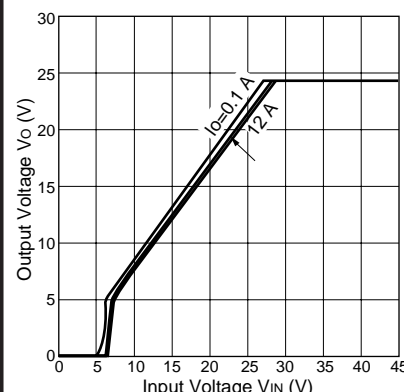

Efficiency Characteristics

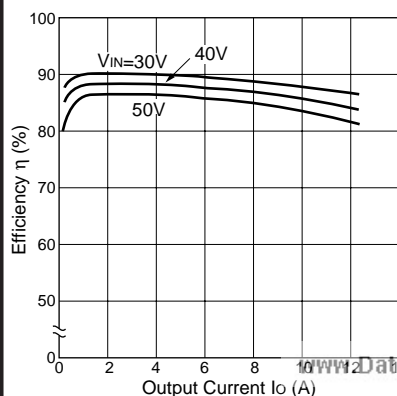

et4U.com

DataShe

www.DataSheet4U.com