

TMC-4F30-xxx

VCSEL TO-46 metal can for general purpose

FEATURES:

- Industry standard TO-46 package with flat window glass.
- Low dependence of power output over temperature.
- Symmetrical beam.
- Packaged with a photodiode.
- Cost-effective laser light source.

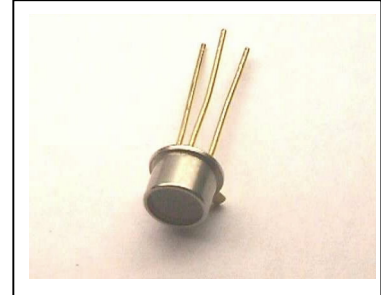

ELECTRO-OPTICAL CHARACTERISTICS:

PARAMETERS	SYMBOL	MIN	TYP	MAX	UNIT	TEST CONDITIONS ⁽¹⁾
Threshold Current	I_{th}		5	10	mA	
Output Power	P_o	1	2	4	mW	$I_F=15\text{ mA}$ ⁽²⁾
Operating Current	I_{OP}		12		mA	Adjustable to establish 1.5 mW output power
Slope Efficiency	η		0.20		mW/mA	$I_F=15\text{ mA}$ ⁽³⁾
Wavelength	λ_p	820	850	870	nm	$I_F=15\text{ mA}$
Forward Voltage	V_F	2.0	2.2	2.5	V	$I_F=15\text{ mA}$
Breakdown voltage	V_{BD}	10	15		V	$I_R=10\text{ }\mu\text{A}$
Series Resistance	R_S		40		Ω	$I_F=15\text{ mA}$
Monitor Current	I_M	1	2		μA	$V_R=5\text{ V}$, $P_o=1.5\text{ mW}$
Beam Divergence	θ		8		degree	$I_F=15\text{ mA}$ ⁽⁴⁾

Notes:

1. All parameters except mentioned are measured at $I_F=15\text{ mA}$, 25°C , CW.
2. Higher power can be provided under request.
3. Slope efficiency is defined as $\Delta P/(15-I_{th})$ at 25°C .
4. Beam divergence is defined as the angle of light intensity at Full Width at Half Maximum (FWHM).

THERMAL CHARACTERISTICS:

PARAMETERS	SYMBOL	MIN	TYP	MAX	UNIT	TEST CONDITIONS
Thermal Resistance	R_{th}		900		$^\circ\text{C}/\text{W}$	$T_A=25^\circ\text{C}$
I_{th} Temperature Variation	ΔI_{th}	-1.5		1.5	mA	$T_A=0\sim 70^\circ\text{C}$
V_F Temperature Coefficient	$\Delta V_F/\Delta T$		-3.0		mV/ $^\circ\text{C}$	$T_A=0\sim 70^\circ\text{C}$, $I_F=15\text{ mA}$
Temperature Coefficient	$\Delta\eta/\Delta T$		-0.20		%/ $^\circ\text{C}$	$T_A=0\sim 70^\circ\text{C}$, $I_F=15\text{ mA}$
λ_p Temperature Coefficient	$\Delta\lambda_p/\Delta T$		0.06		nm/ $^\circ\text{C}$	$T_A=0\sim 70^\circ\text{C}$, $I_F=15\text{ mA}$

ABSOLUTE MAXIMUM RATINGS:

PARAMETERS	MIN	MAX	UNIT	CONDITIONS
Storage Temperature	-40	125		
Operating Temperature	-20	85		
Lead Solder Temperature		260		5 seconds
Continuous Forward Current		40	mA	
Continuous Reverse Voltage		10	V	

Fig. 1 Typical Optical Characteristics

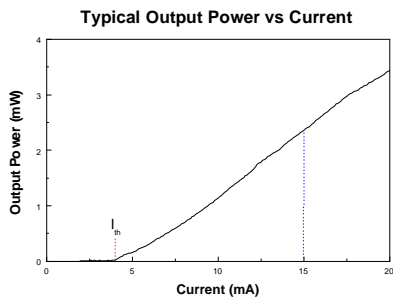

Fig. 2 Typical Electrical Characteristics

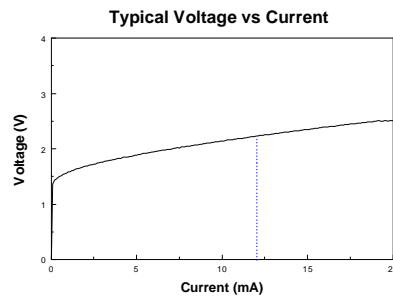
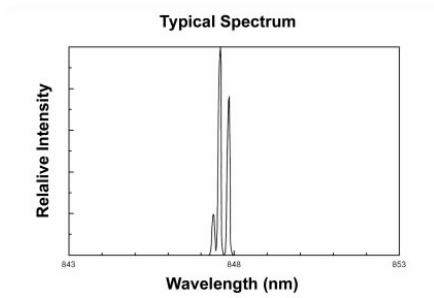
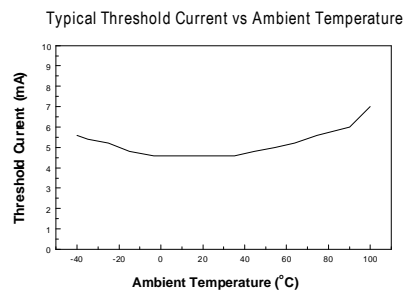

Fig. 3 Spectrum When Driving Current 15 mA



3 transverse modes typically.

Fig. 4 Temperature Dependence of Threshold Current



WARNING:

The VCSEL is a class IIIb laser in the safety standard ANSI Z136.1 and should be treated as a potential eye hazard.

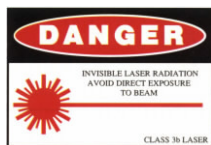

OUTLINE DIMENSIONS:

• Unit: mm

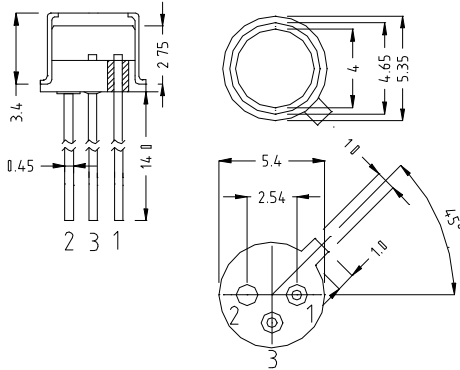

• PINOUT:

TMC-4F30-801

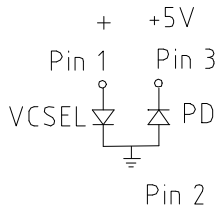

Pin 1: VCSEL Anode

Pin 2: VCSEL Cathode
PD Anode
Case

Pin 3: PD Cathode

TMC-4F30-802

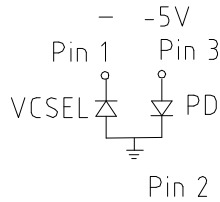

Pin 1: VCSEL Cathode

Pin 2: VCSEL Anode
PD Cathode
Case

Pin 3: PD Anode

TMC-4F30-803

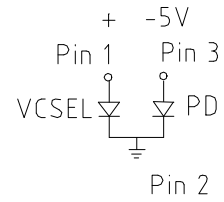

Pin 1: VCSEL Anode

Pin 2: VCSEL Cathode
PD Cathode
Case

Pin 3: PD Anode