

0.8 μ A Low Power Consumption Dual Voltage Regulator

GENERAL DESCRIPTION

The XC6411/6412 series are highly precise, low noise, positive voltage LDO dual regulators manufactured using CMOS processes. The series achieves very low supply current, 0.8 μ A / ch. (TYP.) and consists of a reference voltage source, an error amplifier, a current foldback circuit, and a phase compensation circuit plus a driver transistor. SOT-25 package for the XC6411P series, SOT-26 package for the XC6412B series and USP-6C package for the XC6412C series (preliminary) make high density mounting possible. Therefore, the series is ideal for applications where high density mounting is required such as in mobile equipment.

Output voltage of each regulators VR1 and VR2 is selectable in 100mV increments within a range of 0.9V to 5.0V by laser trimming. The series is also compatible with low ESR ceramic capacitors, which give added output stability. VR1 and VR2 are completely isolated. For this, a cross talk between each channel, which causes a problem during load fluctuations, can be greatly reduced, and the stabilized voltage can be supplied. The current limiter's foldback circuit also operates as a short protect for the output pin.

APPLICATIONS

- MP3 players, Portable AV equipment
- Mobile phones
- Cordless phones,
wireless communication equipment
- Portable games
- Cameras, Video recorders
- PDAs

FEATURES

- Maximum Output Current** : 200mA (300mA Limit, TYP.)
@ $V_{OUT}=3.0V$, $V_{IN}=4.0V$
- Dropout Voltage** : 320mV @ $I_{OUT} = 100mA$
@ $V_{OUT} = 3.0V$
- Input Voltage Range** : 1.5V ~ 6.0V
- Output Voltage Range** : 0.9V ~ 5.0V (100mV increments)
- Highly Accurate** : Set voltage accuracy $\pm 2\%$
($1.5V < V_{OUT(T)} \leq 5.0V$)
Set voltage accuracy $\pm 30mV$
($0.9V \leq V_{OUT(T)} \leq 1.5V$)
- Low Power Consumption** : 0.8 μ A / ch.(TYP.)
- Operating Temperature Range** : - 40 $^{\circ}C$ ~ 85 $^{\circ}C$
- Low ESR Capacitor Compatible**: Ceramic capacitor
- Current Limiter Circuit Built-In**
- Ultra Small Packages** : SOT-25 (XC6411P)
: SOT-26 (XC6412B)
: USP-6C (XC6412C) *Preliminary

TYPICAL APPLICATION CIRCUIT

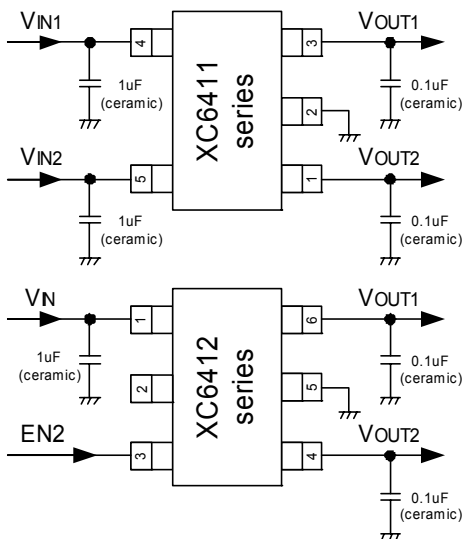

TYPICAL PERFORMANCE CHARACTERISTICS

- Supply Current vs. Input Voltage

VR1/VR2: 3.0V

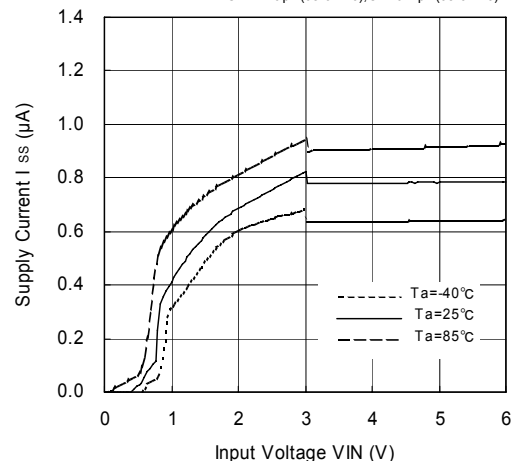
CIN=1.0 μ F(ceramic), CL=0.1 μ F(ceramic)

PIN CONFIGURATION

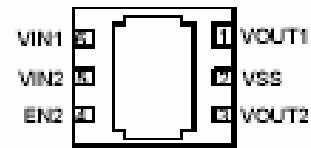
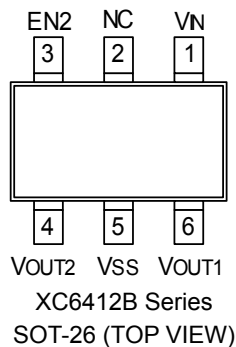
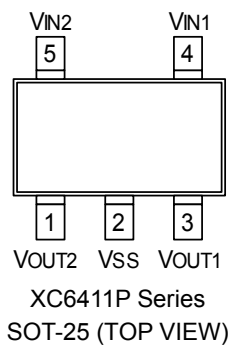

*Preliminary

* The dissipation pad for the USP-6C package should be solder-plated in recommended mount pattern and metal masking so as to enhance mounting strength and heat release. If the pad needs to be connected to other pins, it should be connected to the Vss pin (pin # 5).

PIN ASSIGNMENT

PIN NUMBER			PIN NAME	FUNCTION
XC6411P SOT-25	XC6412B SOT-26	XC6412C USP-6C		
1	4	3	VOUT2	Output 2
2	5	2	VSS	Ground
3	6	1	VOUT1	Output 1
-	1	-	VIN	Power Input
4	-	6	VIN1	Power Input 1
5	-	5	VIN2	Power Input 2
-	3	4	EN2	ON / Off Switch (ch. 2)
-	2	-	NC	No Connection

* When using an SOT-26 package of the XC6412B series, please use No. 1 pin as power input of the whole IC.

PRODUCT CLASSIFICATION

Ordering Information

XC6411P①②③④⑤

XC6412B①②③④⑤

XC6412C①②③④⑤ *Preliminary

DESIGNATOR	DESCRIPTION	SYMBOL	DESCRIPTION
①②③	Output Voltage	001~	: Internally set sequential number relating output voltage of each regulator. Regulator 1 and 2 output voltage range→0.9~5.0V (100V increments)
④	Package	M	: SOT-25 (XC6411P) : SOT-26 (XC6412B)
		E	: USP-6C (XC6412C)
⑤	Device Orientation	R	: Embossed tape, standard feed
		L	: Embossed tape, reverse feed

BLOCK DIAGRAMS

●XC6411P Series

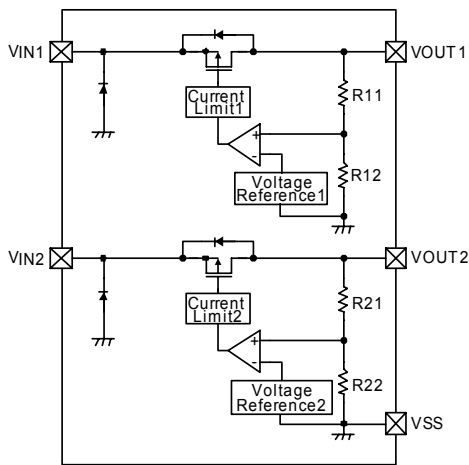

●XC6412B Series (SOT-26)

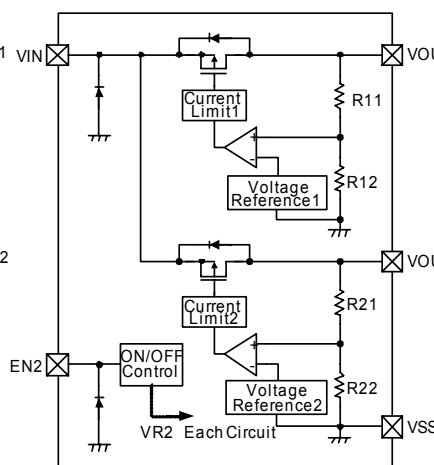

●XC6412C Series (USP-6C)

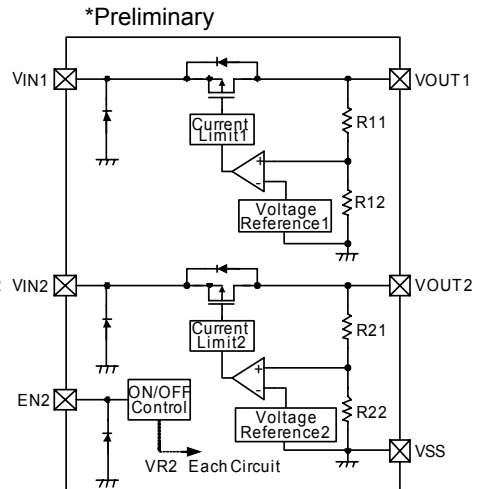

* Diodes shown in the above circuit are ESD protection diodes and parasitic diodes.

ABSOLUTE MAXIMUM RATINGS

Ta = 25°C

PARAMETER	SYMBOL	RATINGS	UNITS
Input Voltage	VIN	- 0.3 ~ + 7.0	V
Input Voltage 1	VIN1	- 0.3 ~ + 7.0	V
Input Voltage 2	VIN2	- 0.3 ~ + 7.0	V
Output Current 1	IOUT1	500 (*1)	mA
Output Current 2	IOUT2	500 (*1)	mA
Output Voltage 1	VOUT1	VSS - 0.3 ~ VIN + 0.3	V
Output Voltage 2	VOUT2	VSS - 0.3 ~ VIN + 0.3	V
EN2 Pin Voltage	VEN2	VSS - 0.3 ~ 0.7	V
Power Dissipation	SOT-25	250	mW
	SOT-26		
	USP-6C		
Operating Temperature Range	Topr	- 40 ~ + 85	°C
Storage Temperature Range	Tstg	- 55 ~ +125	°C

Note: *1: Please set the value of the XC6411P and XC6412C (USP-6C) series within the following equation:

$$Pd > [(VIN1 - VOUT1) \times IOUT1 + (VIN2 - VOUT2) \times IOUT2]$$

Please set the value of the XC6412B (SOT-26) series within the following equation:

$$Pd > [(VIN - VOUT1) \times IOUT1 + (VIN - VOUT2) \times IOUT2]$$

ELECTRICAL CHARACTERISTICS

XC6411P/6412 Series, Regulator 1 and Regulator 2

Ta = 25°C

PARAMETER	SYMBOL	CONDITIONS	MIN.	TYP.	MAX.	UNIT.	CIRCUIT
Output Voltage (*2)	V _{OUT(E)}	V _{IN} =V _{OUT(T)} (*1) + 1.0V, I _{OUT} =1mA	E-0 (*6)			V	①
Maximum Output Current	I _{OUTMAX}	V _{IN} =V _{OUT(T)} + 1.0V V _{OUT(T)} =0.9V	50	70	-	mA	①
		V _{IN} =V _{OUT(T)} + 1.0V V _{OUT(T)} =1.0V ~ 1.1V	60	80	-		
		V _{IN} =V _{OUT(T)} + 1.0V V _{OUT(T)} =1.2V ~ 1.3V	80	110	-		
		V _{IN} =V _{OUT(T)} + 1.0V V _{OUT(T)} =1.4V ~ 1.6V	100	140	-		
		V _{IN} =V _{OUT(T)} + 1.0V V _{OUT(T)} =1.7V ~ 2.2V	120	150	-		
		V _{IN} =V _{OUT(T)} + 1.0V V _{OUT(T)} =2.3V ~ 2.9V	150	195	-		
		V _{IN} =V _{OUT(T)} + 1.0V V _{OUT(T)} ≥3.0V	200	300	-		
Load Regulation	ΔV _{OUT}	V _{IN} =V _{OUT(T)} + 1.0V, V _{OUT(T)} = 0.9V 1mA ≤ I _{OUT} ≤ 50mA	-	15	70	mV	①
		V _{IN} =V _{OUT(T)} + 1.0V V _{OUT(T)} = 1.0V ~ 1.1V 1mA ≤ I _{OUT} ≤ 60mA					
		V _{IN} =V _{OUT(T)} + 1.0V V _{OUT(T)} = 1.2V~1.3V 1mA ≤ I _{OUT} ≤ 80mA					
		V _{IN} =V _{OUT(T)} + 1.0V V _{OUT(T)} ≥ 1.4V 1mA ≤ I _{OUT} ≤ 100mA					
Dropout Voltage (*3)	V _{dif}	V _{OUT(T)} = 0.9V, I _{OUT} = 50mA	E-1(*6)			mV	①
		V _{OUT(T)} = 1.0V ~ 1.1V, I _{OUT} = 60mA					
		V _{OUT(T)} = 1.2V ~ 1.3V, I _{OUT} = 80mA					
		V _{OUT(T)} ≥ 1.4V, I _{OUT} = 100mA					
Line Regulation	ΔV _{OUT} / ΔV _{IN} · V _{OUT}	V _{OUT(T)} = 0.9V, 1.5V ≤ V _{IN} ≤ 6.0V, I _{OUT} = 1mA	-	0.05	0.15	%V	①
		V _{OUT(T)} = 1.0V~1.2V, V _{OUT(T)} + 0.5V ≤ V _{IN} ≤ 6.0V I _{OUT} = 1mA					
		V _{OUT(T)} ≥ 1.3V, V _{OUT(T)} + 0.5V ≤ V _{IN} ≤ 6.0V I _{OUT} = 30mA					
Input Voltage	V _{IN}	-	1.5	-	6.0	V	-
Output Voltage Temperature Characteristics	ΔV _{OUT} / ΔT _{opr} · V _{OUT}	V _{IN} = V _{OUT(T)} + 1.0V, I _{OUT} = 30mA, - 40°C ≤ T _{opr} ≤ 85°C	-	±100	-	ppm / °C	①

■ ELECTRICAL CHARACTERISTICS (Continued)

XC6411P/6412 Series, Regulator 1 and Regulator 2 (Continued)

Ta = 25°C

PARAMETER	SYMBOL	CONDITIONS	MIN.	TYP.	MAX.	UNIT.	CIRCUIT
Current Limit	ILIM	VOUT=VOUT(E)×0.95 VOUT(T)=0.9V VIN=VOUT(T)+2.0V	100	300	-	mA	①
		VOUT=VOUT(E)×0.95 VOUT(T)=1.0V ~ 1.1V VIN=VOUT(T)+2.0V	120	300	-		
		VOUT=VOUT(E)×0.95 VOUT(T)=1.2V ~ 1.3V VIN=VOUT(T)+2.0V	160	300	-		
		VOUT=VOUT(E)×0.95 VOUT(T)=1.4V ~ 2.9V VIN=VOUT(T)+2.0V	200	300	-		
		VOUT=VOUT(E)×0.95 VOUT(T)≥3.0V VIN=VOUT(T)+1.0V	200	300	-		
Short Circuit Current	Ishort	VIN=VOUT(T)+1.0V, VOUT=0V	-	50	-	mA	①

NOTE: *1: VOUT(T): Setting output voltage

*2: VOUT(E) = Effective output voltage

(i.e. the output voltage when "VOUT(T) + 1.0V" is provided at the VIN pin while maintaining a certain IOUT value).

*3: $V_{dif} = \{V_{IN0}^{(4)} - V_{OUT0}^{(5)}\}$

*4: VIN0 = The input voltage when VOUT0 appears as input voltage is gradually decreased.

*5: VOUT0 = A voltage equal to 98% of the output voltage whenever an amply stabilized IOUT {VOUT(T) + 1.0V} is input.

*6: Refer to "VOLTAGE CHART".

*7: Unless otherwise stated, VEN2=VIN for the XC6412 series.

*8: When the series are the XC6411P and XC6412C series, "VIN" shown in the conditions represents VIN1 or VIN2.

ELECTRICAL CHARACTERISTICS (Continued)

XC6411P Series: Regulator 1, Regulator 2 (each channel)

Ta = 25°C

PARAMETER	SYMBOL	CONDITIONS	MIN.	TYP.	MAX.	UNIT.	CIRCUIT
Supply Current	IDD	VIN=VOUT(T) + 1.0V VOUT(T) ≤ 3.9V	-	0.8	1.5	μA	②
		VIN=VOUT(T) + 1.0V VOUT(T) ≥ 4.0V		1.0	1.8	μA	②

XC6412B Series (SOT-26)

Ta = 25°C

PARAMETER	SYMBOL	CONDITIONS	MIN.	TYP.	MAX.	UNIT.	CIRCUIT
Supply Current 2 (*8)	IDD2	VIN=VOUT(T) + 1.0V, VEN2=VIN VOUT(T) ≤ 3.9V	-	1.6	3.0	μA	②
		VIN=VOUT(T) + 1.0V, VEN2=VIN VOUT(T) ≥ 4.0V	-	2.0	3.6	μA	②
Supply Current 3 (*9)	IDD3	VIN=VOUT(T) + 1.0V, VEN2=VIN VOUT(T) ≤ 3.9V	-	0.8	1.6	μA	②
		VIN=VOUT(T) + 1.0V, VEN2=VIN VOUT(T) ≥ 4.0V	-	1.0	1.9	μA	②
EN 'H' Level Voltage	VENH	VIN=VOUT(T)+1.0V	1.0	-	6.0	V	①
EN 'L' Level Voltage	VENL	VIN=VOUT(T)+1.0V	-	-	0.3	V	①
EN 'H' Level Current	IENH	VIN=VOUT(T)+1.0V, VEN2=VIN	- 0.1	-	0.1	μA	②
EN 'L' Level Current	IENL	VIN=VOUT(T)+1.0V, VEN2=VIN	- 0.1	-	0.1	μA	②

NOTE:

*8: Supply current of the IC: (VR1 supply current + VR2 supply current)

*9: Supply current of the IC when VR2 is in stand-by mode: (VR1 supply current + VR2 stand-by current)

XC6412C Series (USP-6C * Preliminary): Regulator 1

Ta = 25°C

PARAMETER	SYMBOL	CONDITIONS	MIN.	TYP.	MAX.	UNIT.	CIRCUIT
VR1 Supply Current	IDD_VR1	VIN=VOUT(T) + 1.0V VOUT(T) ≤ 3.9V	-	0.8	1.5	μA	②
		VIN=VOUT(T) + 1.0V VOUT(T) ≥ 4.0V		1.0	1.8	μA	②

XC6412C Series (USP-6C *Preliminary): Regulator 2

Ta = 25°C

PARAMETER	SYMBOL	CONDITIONS	MIN.	TYP.	MAX.	UNIT.	CIRCUIT
VR2 Supply Current	IDD_VR2	VIN=VOUT(T) + 1.0V, VEN2=VIN VOUT(T) ≤ 3.9V	-	0.8	1.5	μA	②
		VIN=VOUT(T) + 1.0V, VEN2=VIN VOUT(T) ≥ 4.0V	-	1.0	1.8	μA	②
VR2 Stand-by Current	Istby	VIN=VOUT(T) + 1.0V, VEN2=VSS	-	-	0.1	μA	②
EN2 'H' Level Voltage	VENH	VIN=VOUT(T)+1.0V	1.0	-	6.0	V	①
EN2 'L' Level Voltage	VENL	VIN=VOUT(T)+1.0V	-	-	0.3	V	①
EN2 'H' Level Current	IENH	VIN=VOUT(T)+1.0V, VEN2=VIN	- 0.1	-	0.1	μA	②
EN2 'L' Level Current	IENL	VIN=VOUT(T)+1.0V, VEN2=VIN	- 0.1	-	0.1	μA	②

■ ELECTRICAL CHARACTERISTICS (Continued)

● Voltage Chart

Ta = 25°C

SETTING OUTPUT VOLTAGE	E-0		E-1	
	OUTPUT VOLTAGE (V)		DROPOUT VOLTAGE (mV)	
	V _{OUT}		V _{dif}	
V _{OUT(T)}	MIN.	MAX.	TYP.	MAX.
0.9	0.870	0.930	870	1000
1.0	0.970	1.030	860	1000
1.1	1.070	1.130	780	950
1.2	1.170	1.230	800	1000
1.3	1.270	1.330	720	900
1.4	1.370	1.430	750	960
1.5	1.470	1.530	700	890
1.6	1.568	1.632	680	860
1.7	1.666	1.734	650	830
1.8	1.764	1.836	630	800
1.9	1.862	1.938	610	780
2.0	1.960	2.040	580	740
2.1	2.058	2.142	580	740
2.2	2.156	2.244	580	740
2.3	2.254	2.346	510	650
2.4	2.352	2.448	510	650
2.5	2.450	2.550	450	580
2.6	2.548	2.652	450	580
2.7	2.646	2.754	450	580
2.8	2.744	2.856	450	580
2.9	2.842	2.958	450	580
3.0	2.940	3.060	320	420
3.1	3.038	3.162	320	420
3.2	3.136	3.264	320	420
3.3	3.234	3.366	320	420
3.4	3.332	3.468	320	420
3.5	3.430	3.570	320	420
3.6	3.528	3.672	320	420
3.7	3.626	3.774	320	420
3.8	3.724	3.876	320	420
3.9	3.822	3.978	320	420
4.0	3.920	4.080	290	380
4.1	4.018	4.182	290	380
4.2	4.116	4.284	290	380
4.3	4.214	4.386	290	380
4.4	4.312	4.488	290	380
4.5	4.410	4.590	290	380
4.6	4.508	4.692	290	380
4.7	4.606	4.794	290	380
4.8	4.704	4.896	290	380
4.9	4.802	4.998	290	380
5.0	4.900	5.100	230	310

TEST CIRCUITS

●XC6411P Series

Circuit ①

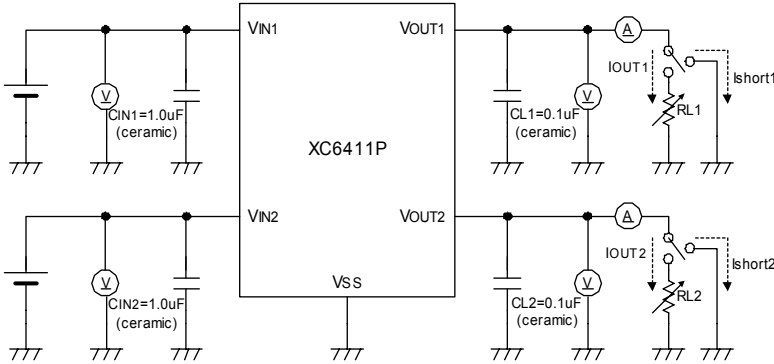

Circuit ②

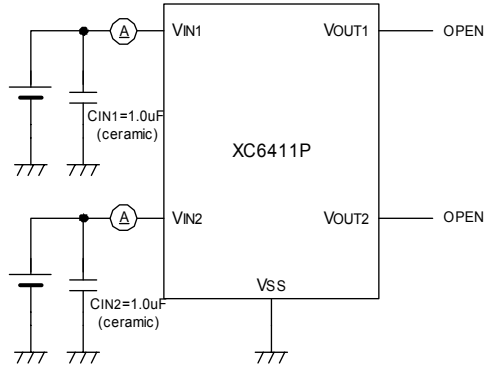

●XC6412B Series (SOT-26)

Circuit ①

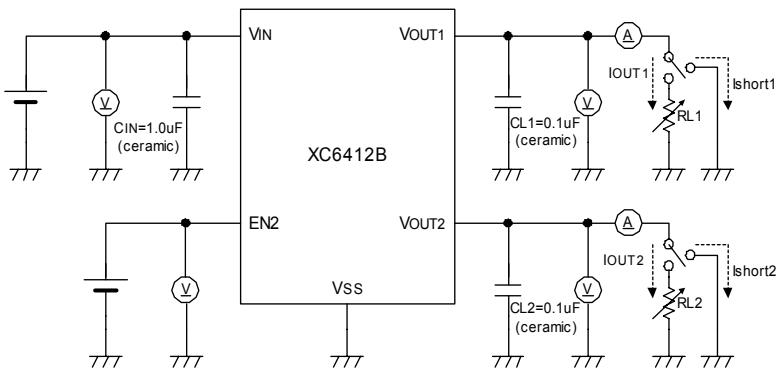

Circuit ②

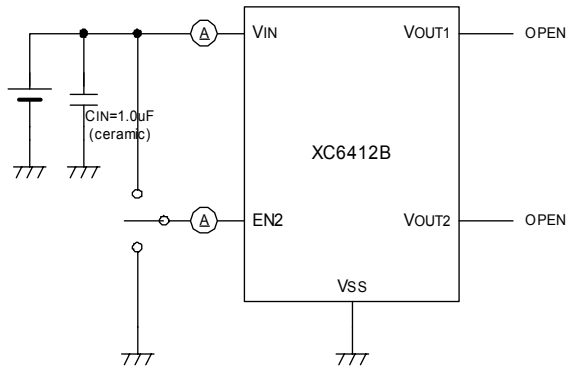

●XC6412C Series (USP-6C) *Preliminary

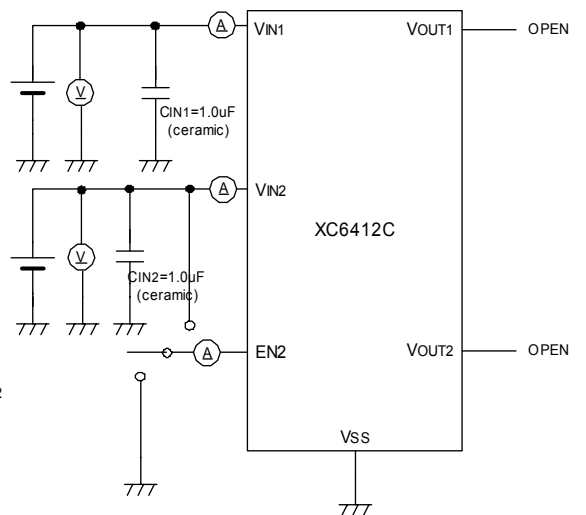
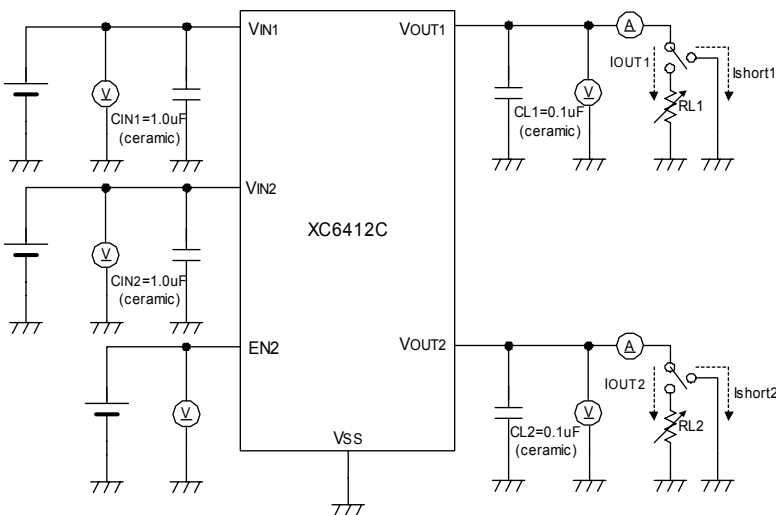

OPERATIONAL EXPLANATION

<Output Voltage Control>

The voltage, divided by resistors R11 & R12 for a regulator 1 and R21 & R22 for a regulator 2 is compared with the internal reference voltage by the error amplifier. These resistors are connected to the VOUT pin. The P-channel MOSFET, which is connected to the VOUT pin, is then driven by the subsequent output signal. The output voltage at the VOUT pin is controlled and stabilized by a system of negative feedback. The current limit circuit operates when the load current reaches the current limit level.

●XC6411P Series

●XC6412B Series (SOT-26)

●XC6412C Series (USP-6C) *Preliminary

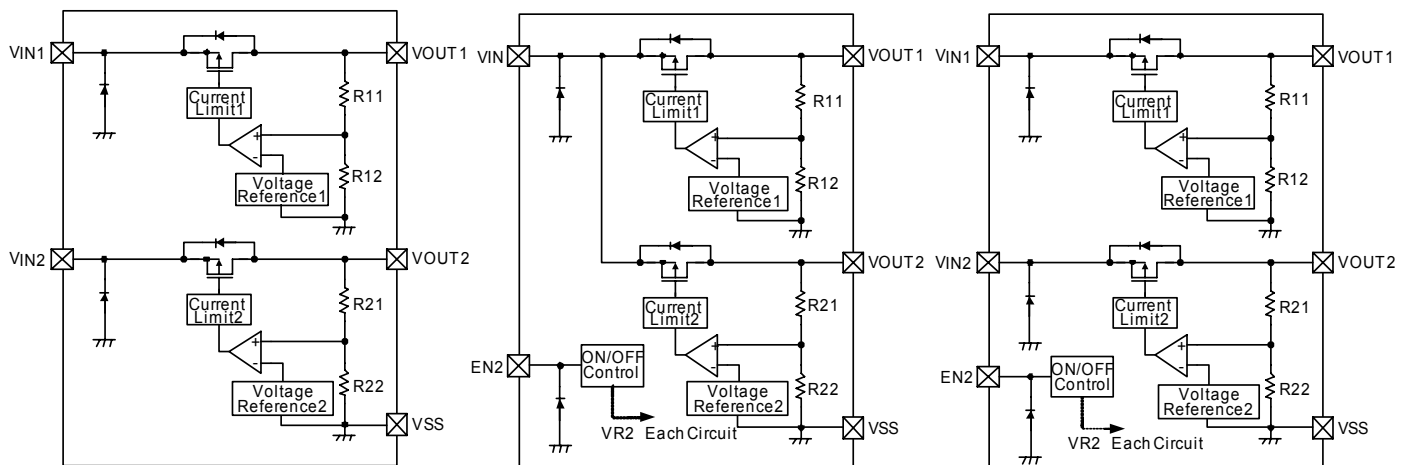

* Diodes shown in the above circuit are ESD protection diodes and parasitic diodes.

<Dual Inputs>

The power input voltage pin of the regulator 1 and regulator 2 in the XC6411P/XC6412C series operate independently of absolute, which makes the circuit structure efficiently.

<Short Protection Circuit>

The XC6411P/6412 series' regulator offers short-circuit protection by means of a built-in foldback circuit. When the load current reaches the current limit level, the fixed current limiter circuit operates and output voltage drops. As a result of this drop in output voltage, the foldback circuit operates, the output voltage drops further and output current decreases. When the output voltage pin is shorted, a current of about 50mA flows.

<EN2 Pin>

The regulator 2's internal circuitry can be operated or shutdown via the signal from the EN2 pin with the XC6412 series. In so doing the regulator 1 maintains an operational state constantly. In shutdown mode, output at the VOUT2 pin will be pulled down to the Vss level via R21 & R22. Note that the XC6412 series' regulator is "High Active/No Pull-Down", operations will become unstable with the EN2 pin open. We suggest that you use this IC with either a VIN voltage or a Vss voltage input at the EN2 pin. If this IC is used with the correct specifications for the EN pin, the operational logic is fixed and the IC will operate normally. However, supply current may increase as a result of through current in the IC's internal circuitry.

NOTES ON USE

1. Please use this IC within the stated absolute maximum ratings. The IC is liable to malfunction should the ratings be exceeded.
2. Where wiring impedance is high, operations may become unstable due to noise and/or phase lag depending on output current.
3. As for the XC6412 series, internally achieved phase compensation makes a stable operation of the IC possible even when there is no output capacitor (CL). In order to stabilize the VIN's voltage level, we recommend that an input capacitor (CIN) of about 0.1 to 1.0 μ F be connected between each VIN pin and the Vss pin. Moreover, during transient response, so as to prevent an undershoot or overshoot, we recommend that the output capacitor (CL) of about 0.1 to 1.0 μ F be connected between each VOUT pin and the Vss pin. However, please wire the input capacitor (CIN) and the output capacitor (CL) as close to the IC as possible.
4. The XC6412C series (USP-6C package) is under development.

TYPICAL PERFORMANCE CHARACTERISTICS

www.DataSheet4U.com

●XC6411P/6412 Series

(1) Output Voltage vs. Output Current

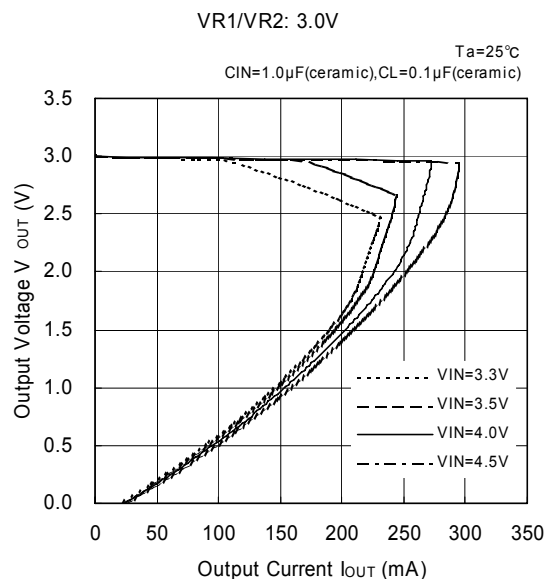
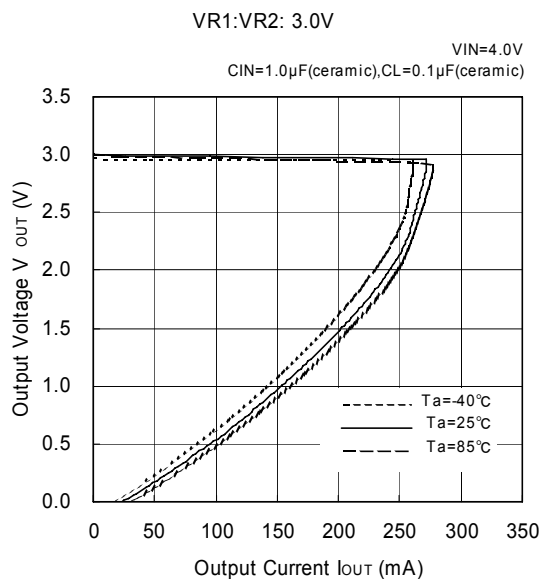
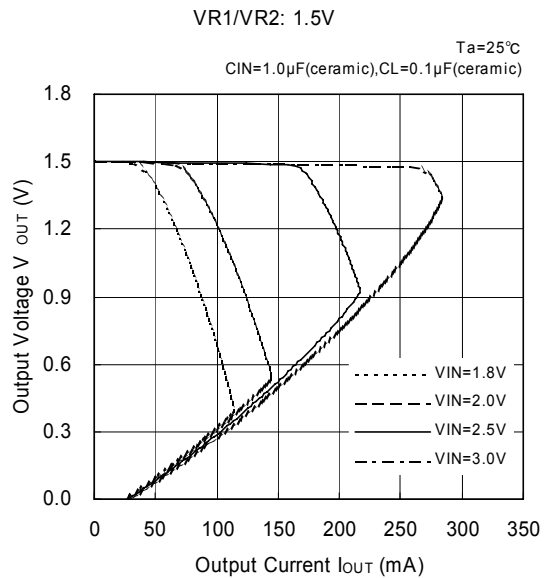
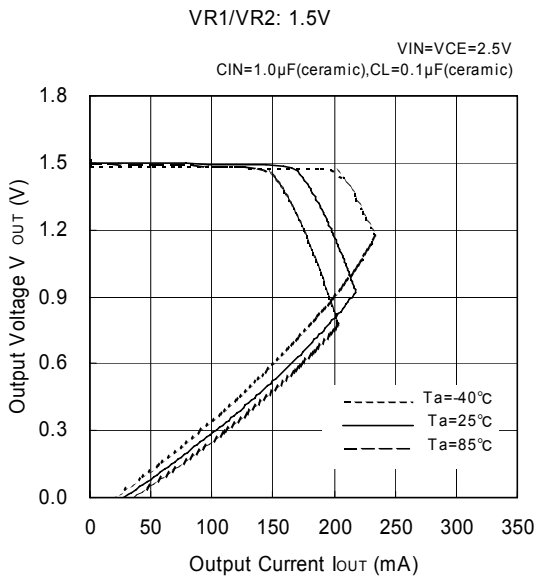
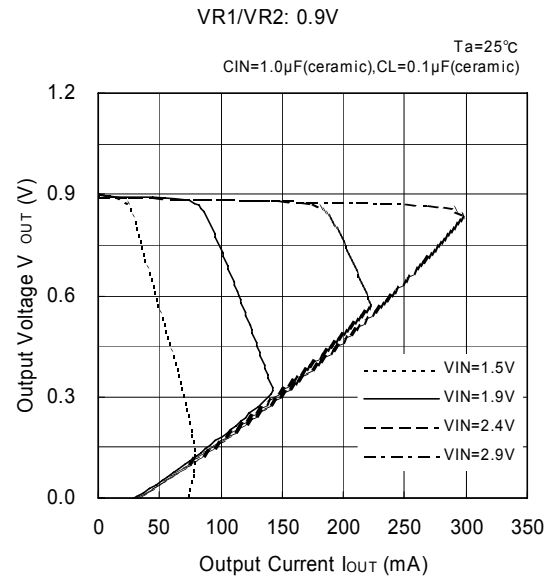
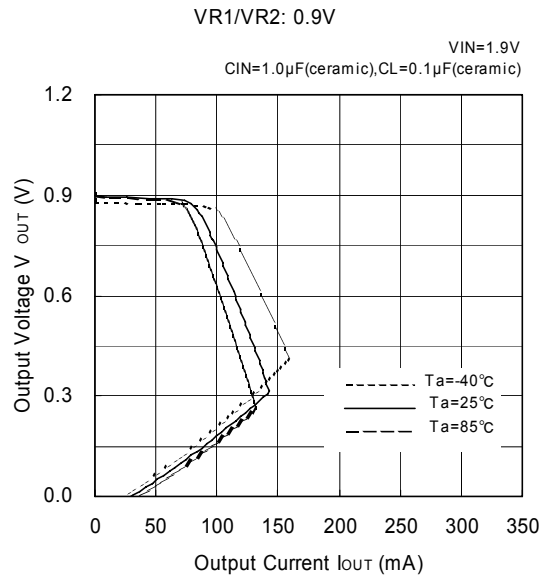

TYPICAL PERFORMANCE CHARACTERISTICS (Continued)

(1) Output Voltage vs. Output Current (Continued)

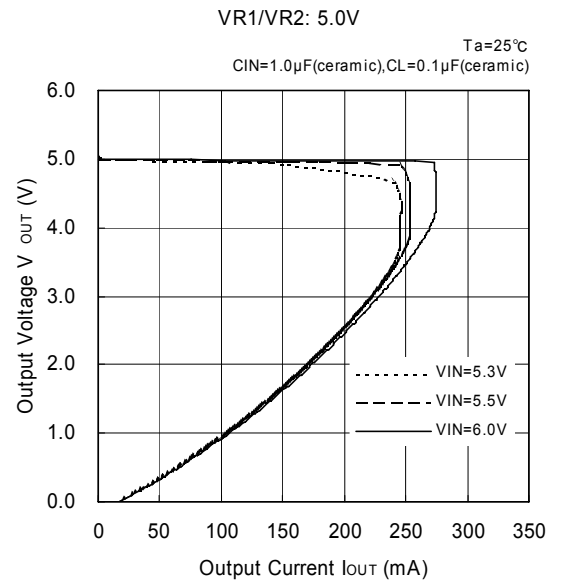
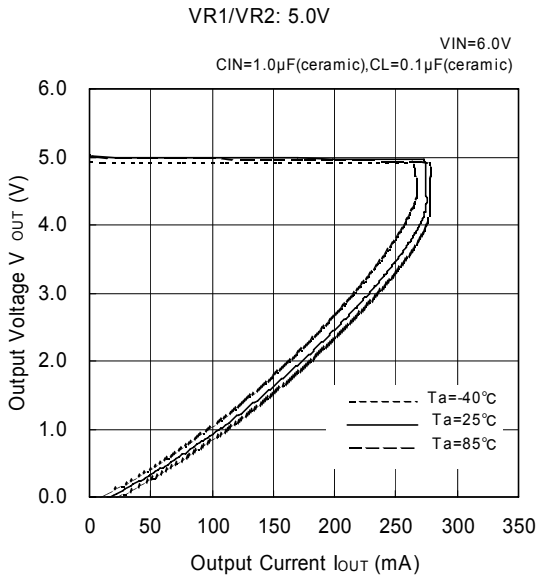

(2) Output Voltage vs. Input Voltage

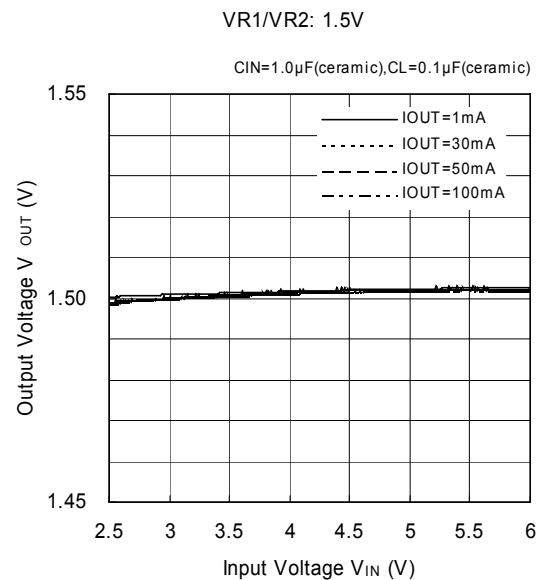
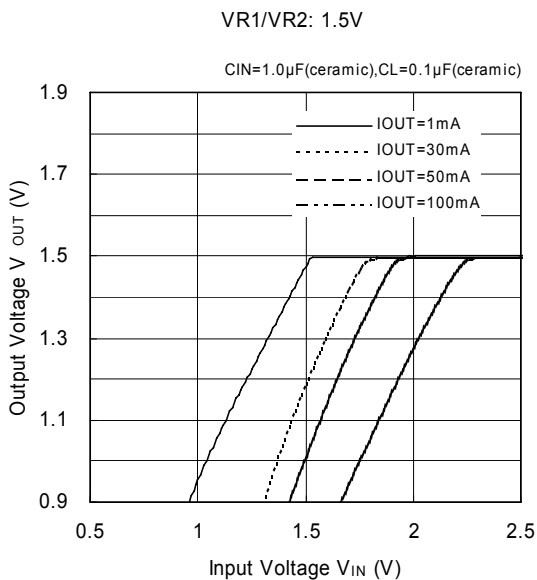
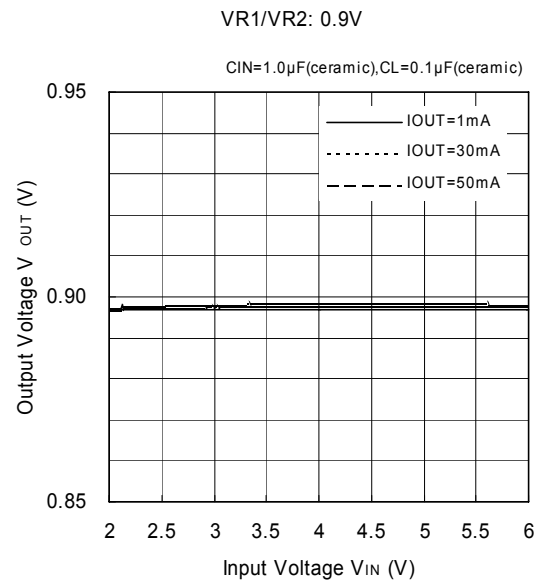
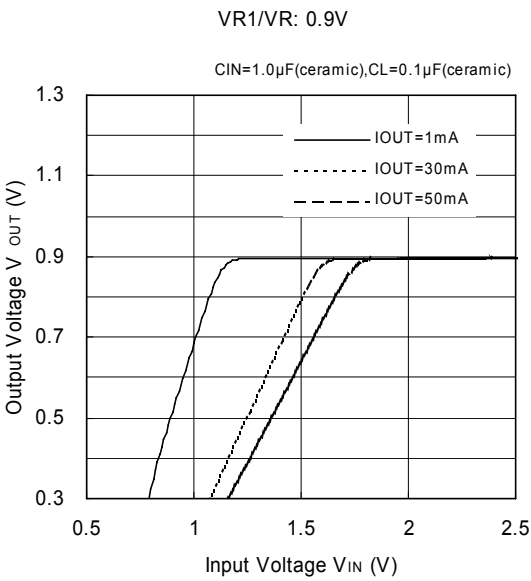

TYPICAL PERFORMANCE CHARACTERISTICS (Continued)

(2) Output Voltage vs. Input Voltage (Continued)

VR1/VR2: 3.0V

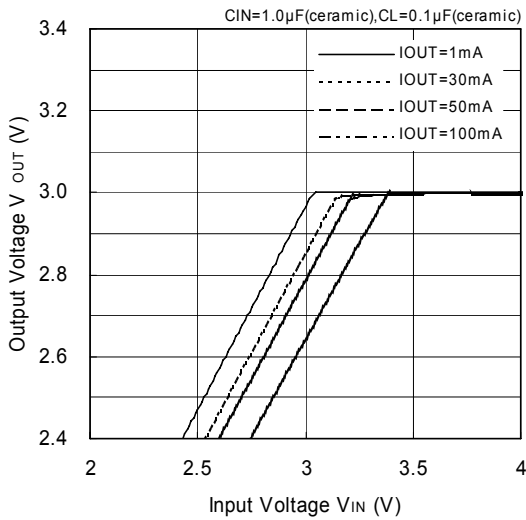

VR1/VR2: 3.0V

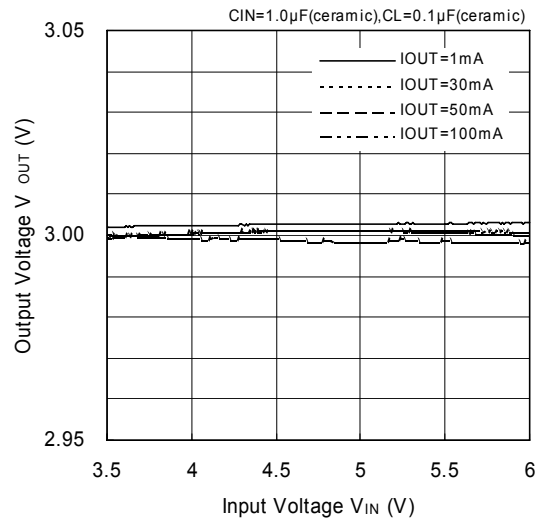

VR1/VR2: 5.0V

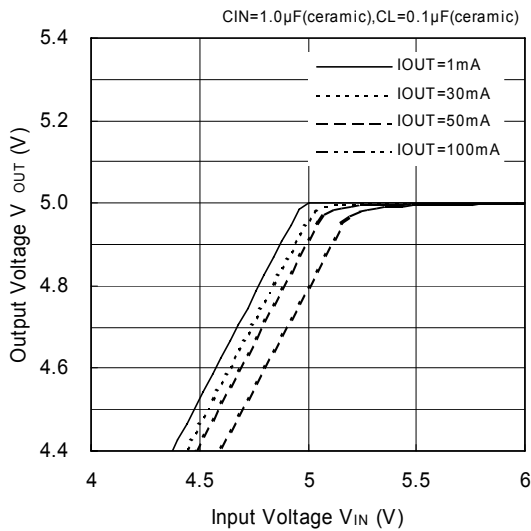

VR1/VR2: 5.0V

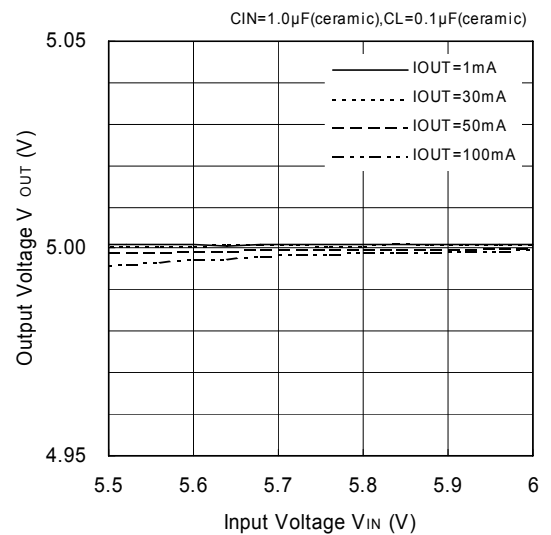

(3) Dropout Voltage vs. Output Current

VR1/VR2: 0.9V

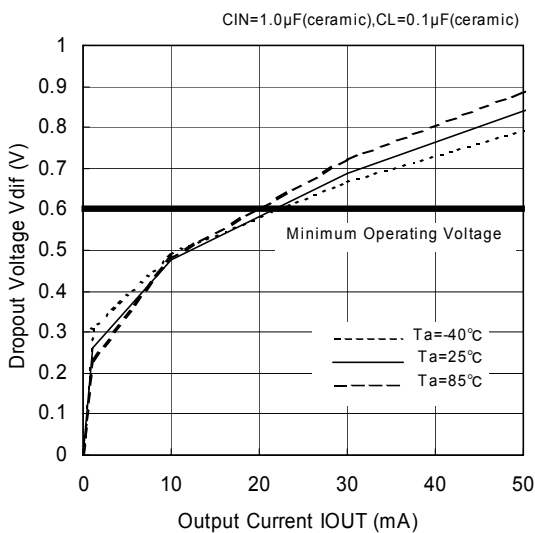

VR1/VR2: 1.5V

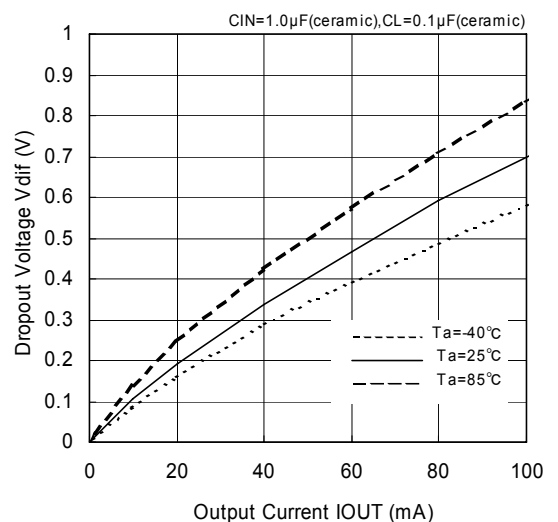

TYPICAL PERFORMANCE CHARACTERISTICS (Continued)

(3) Dropout Voltage vs. Output Current (Continued)

VR1/VR2: 3.0V

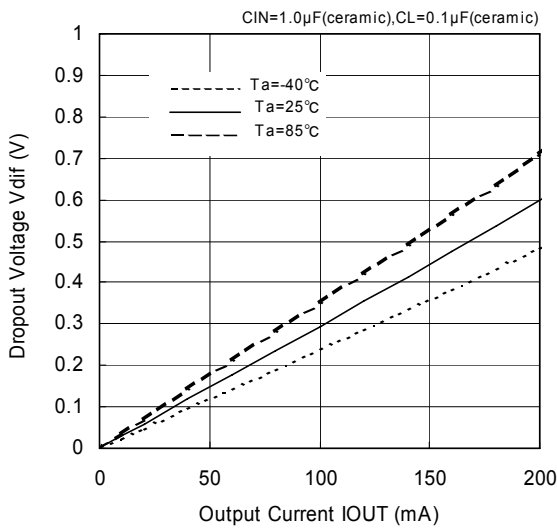

VR1/VR2: 5.0V

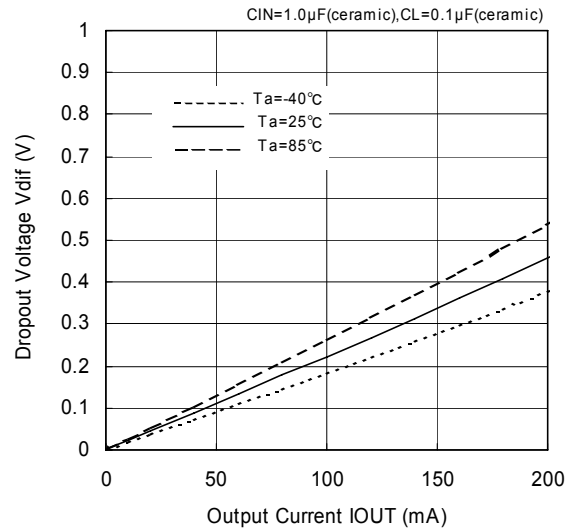

(4) Supply Current vs. Input Voltage

VR1/VR2: 0.9V

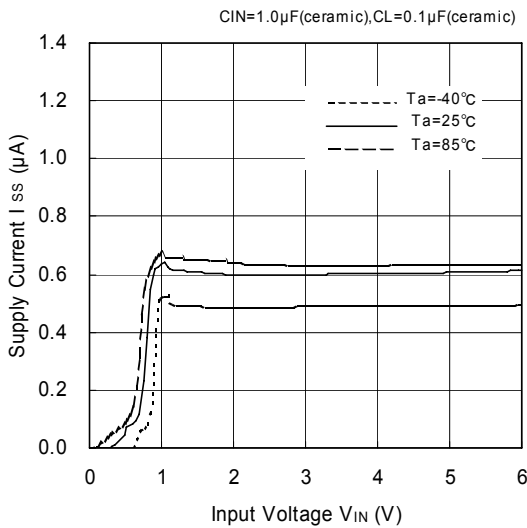

VR1/VR2: 1.5V

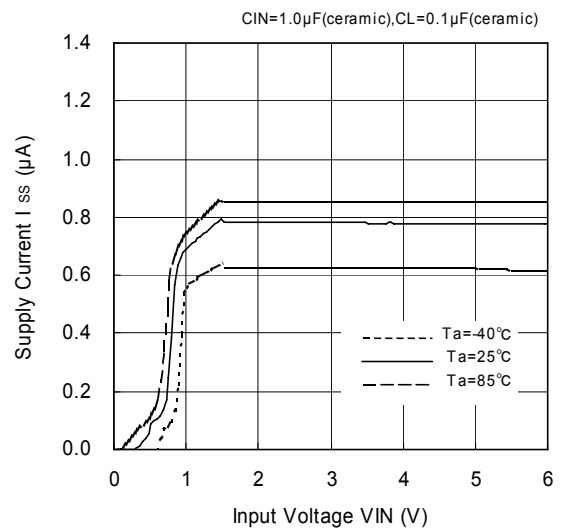

VR1/VR2: 3.0V

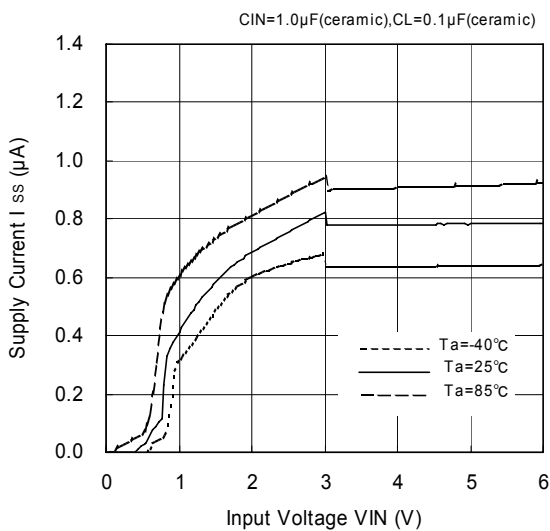

VR1/VR2: 5.0V

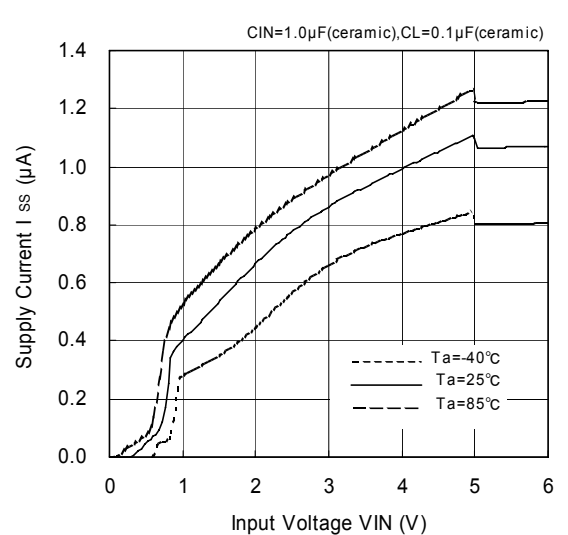

TYPICAL PERFORMANCE CHARACTERISTICS (Continued)

(5) Output Voltage vs. Ambient Temperature

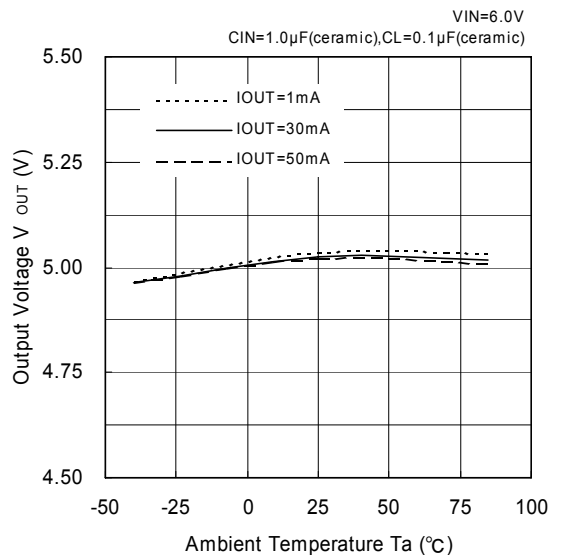
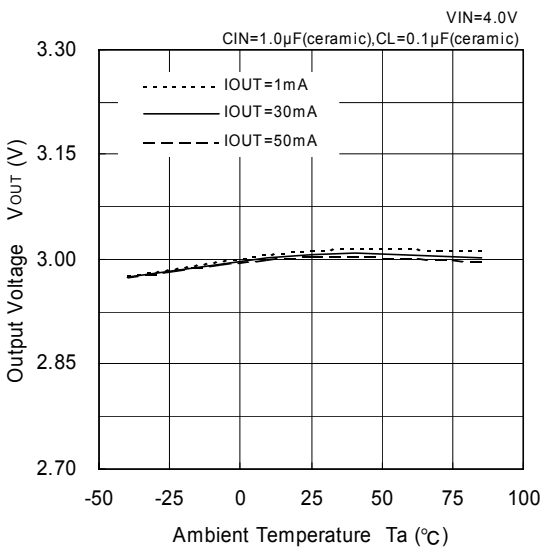
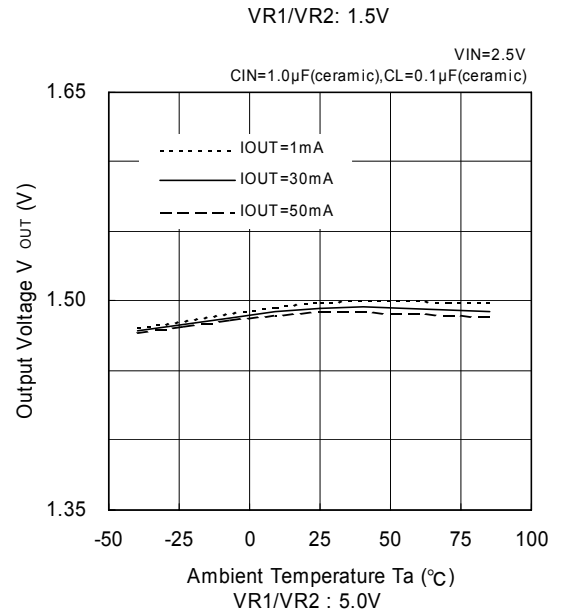
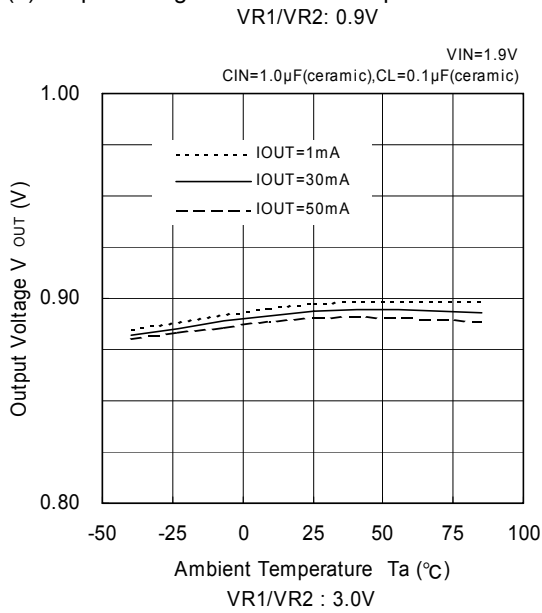

(6) Supply Current vs. Ambient Temperature

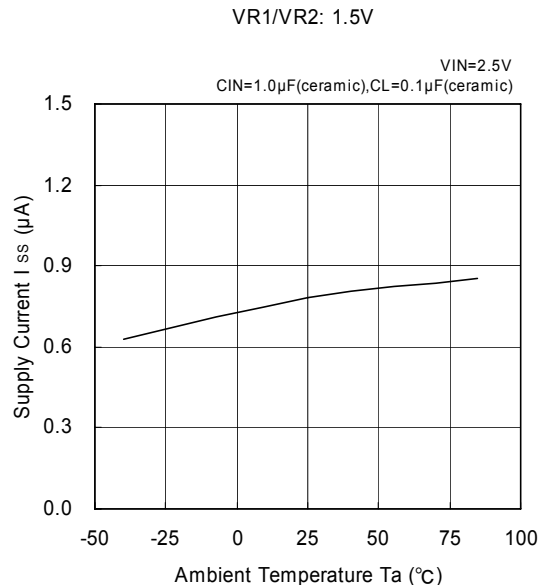
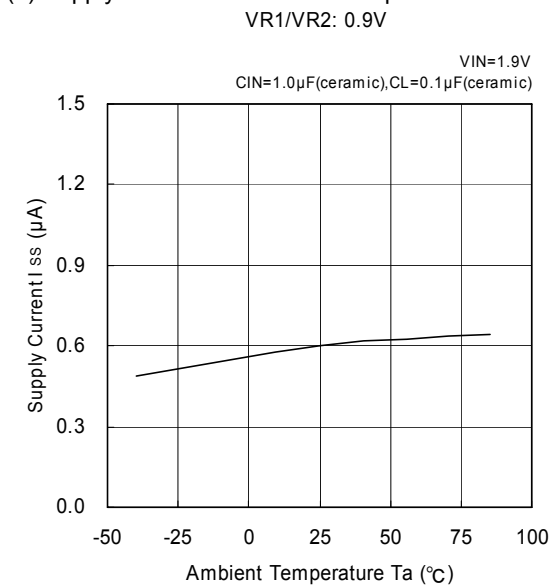

TYPICAL PERFORMANCE CHARACTERISTICS (Continued)

www.DataSheet4U.com

(6) Supply Current vs. Ambient Temperature (Continued)

VR1/VR2: 3.0V

VR1/VR2: 5.0V

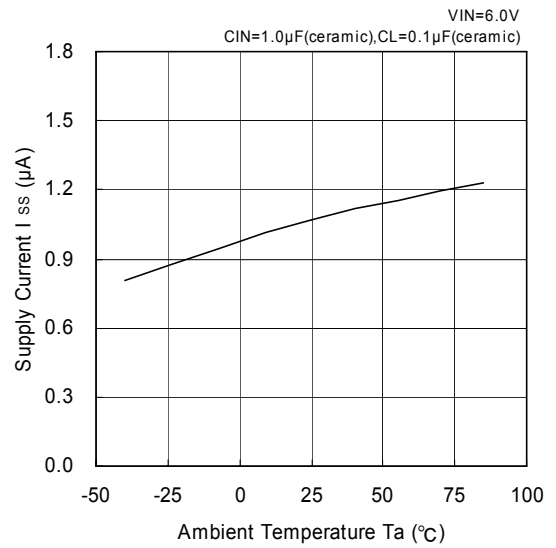
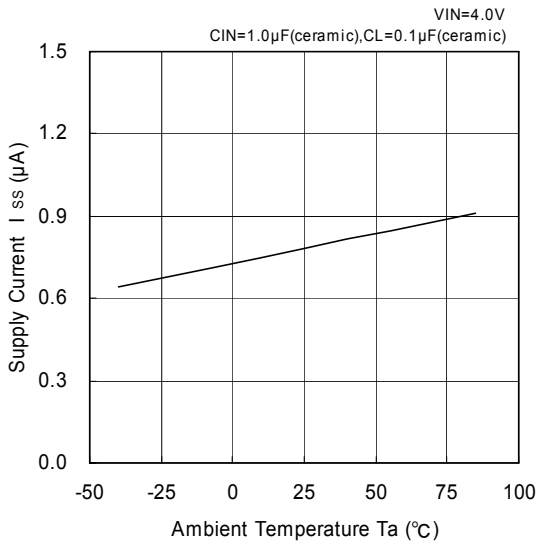

(7) EN2 Threshold Voltage vs. Ambient Temperature (XC6412 series)

XC6412B (VR2: 0.9V)

XC6412B (VR2: 1.5V)

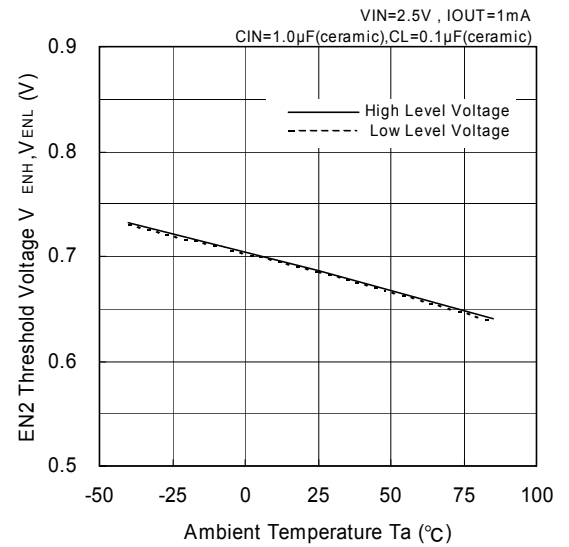
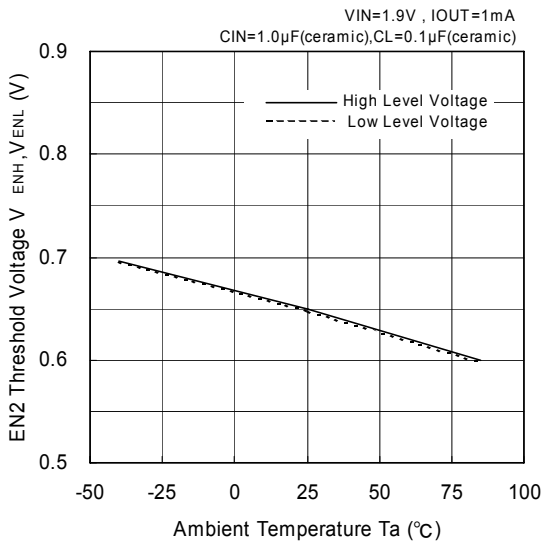

XC6412B (VR2: 3.0V)

XC6412B (VR2: 5.0V)

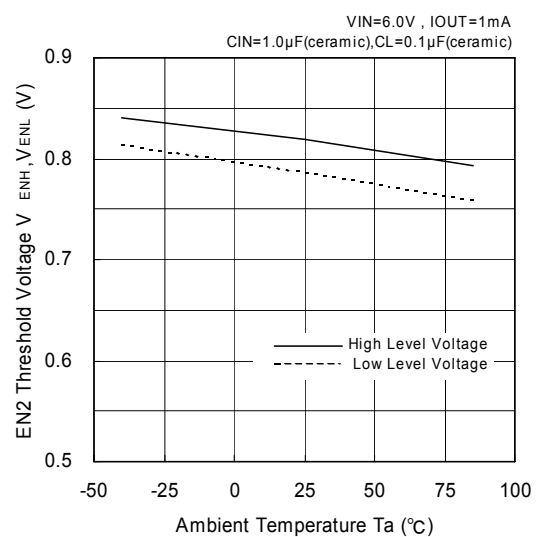
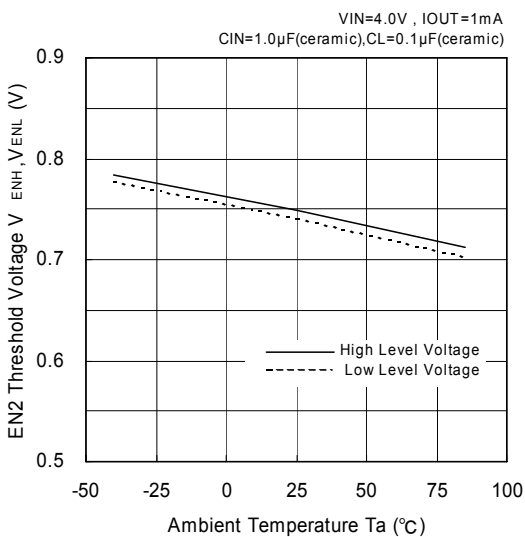

TYPICAL PERFORMANCE CHARACTERISTICS (Continued)

(8) Input Transient Response

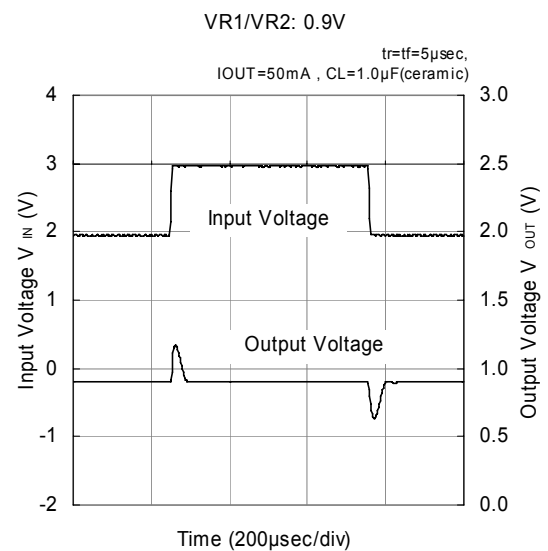
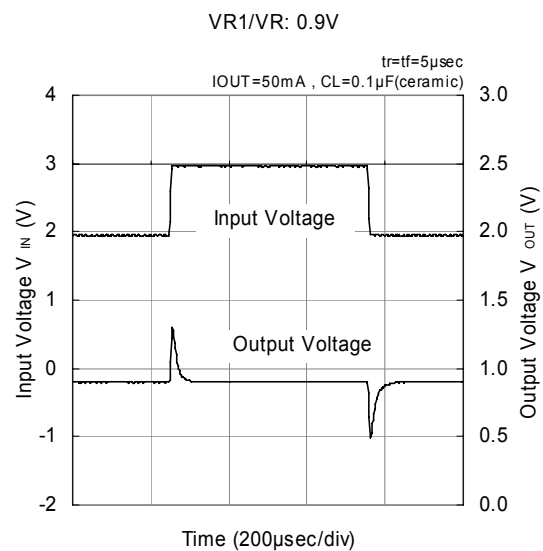
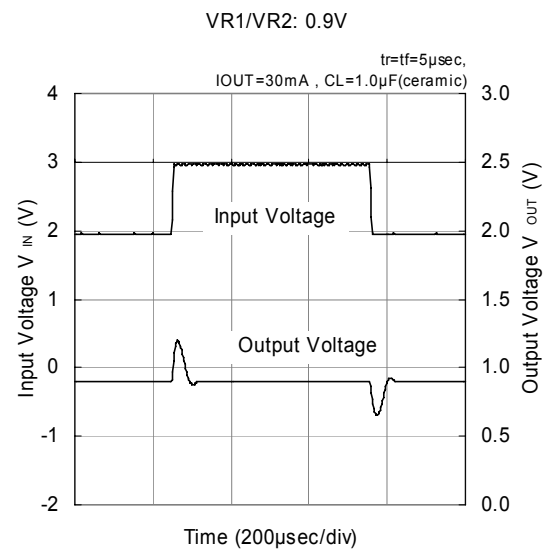
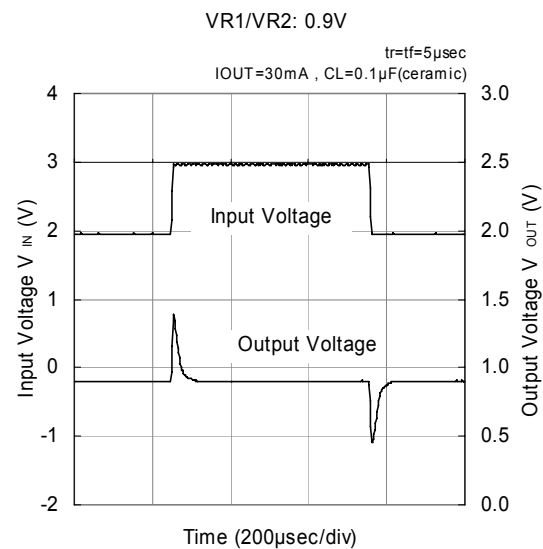
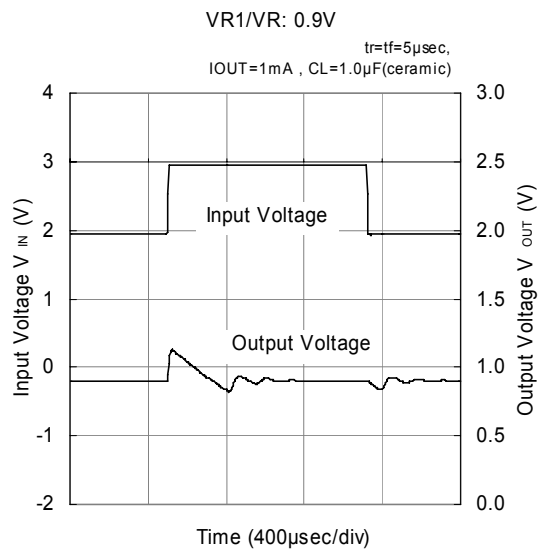
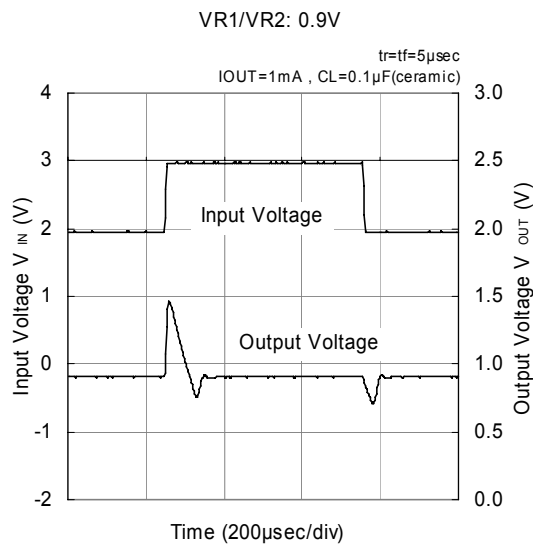

TYPICAL PERFORMANCE CHARACTERISTICS (Continued)

www.DataSheet4U.com

(8) Input Transient Response (Continued)

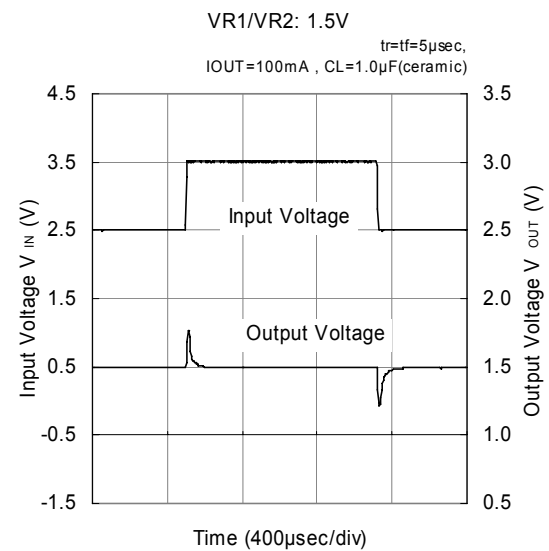
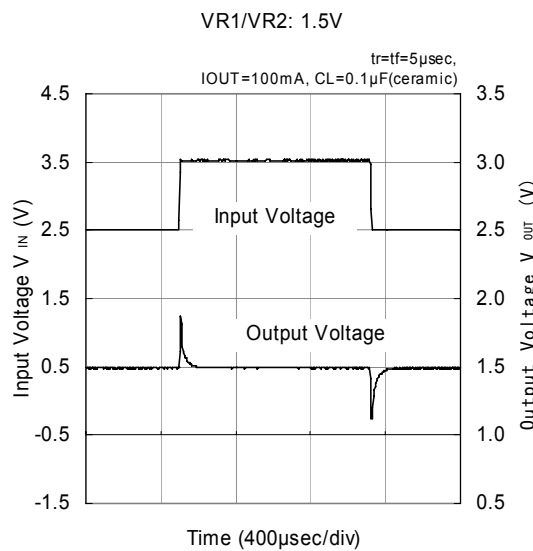
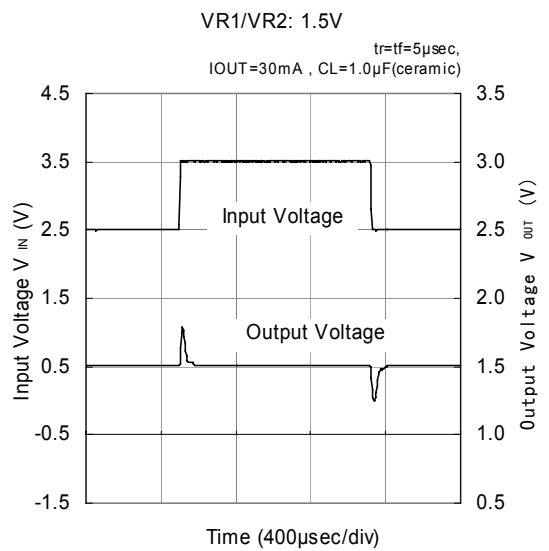
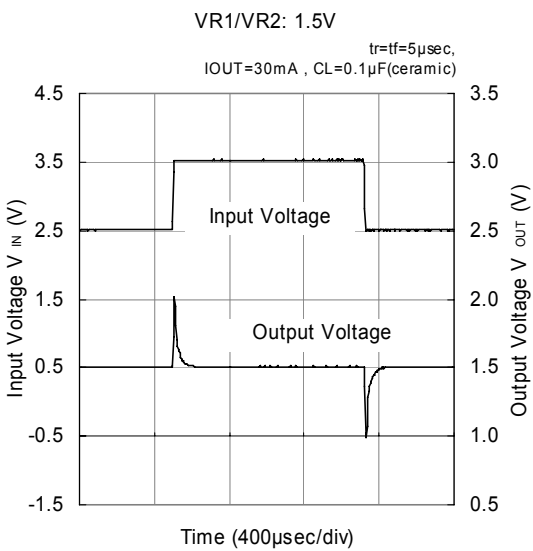
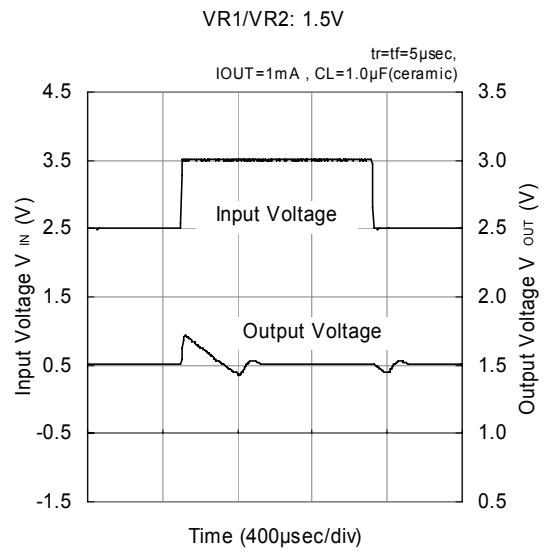
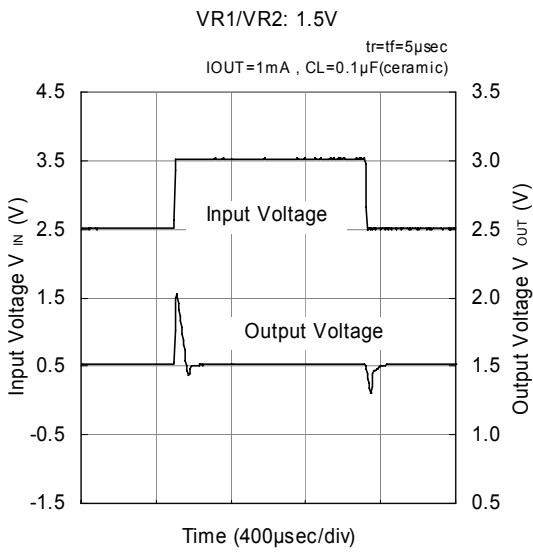

TYPICAL PERFORMANCE CHARACTERISTICS (Continued)

www.DataSheet4U.com

(8) Input Transient Response (Continued)

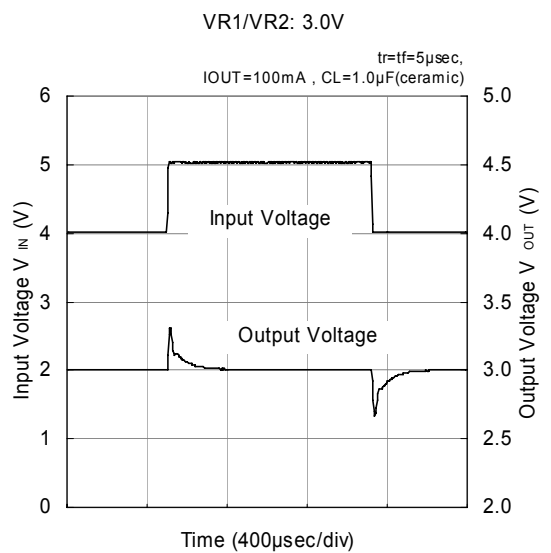
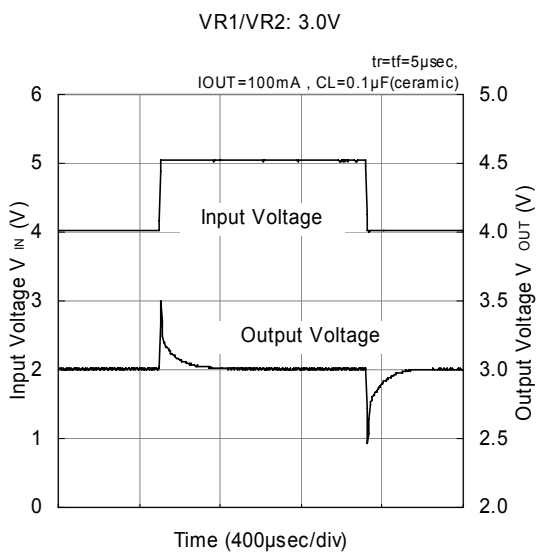
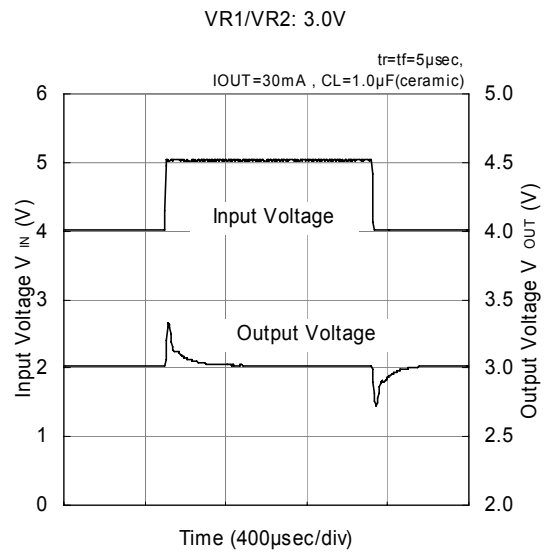
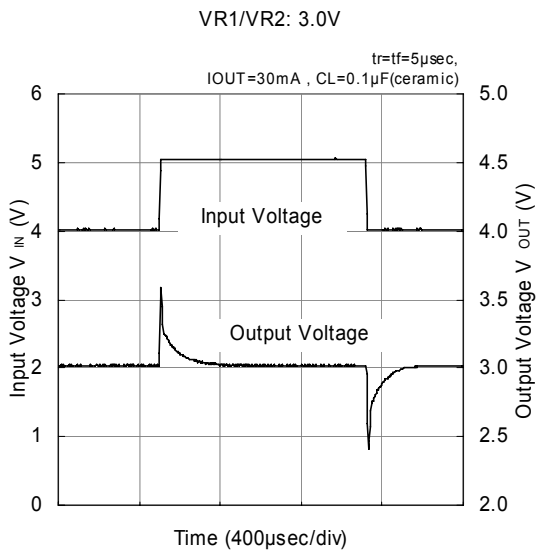
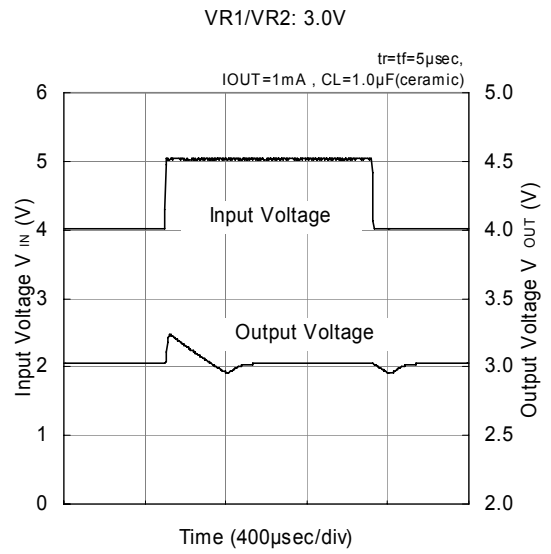
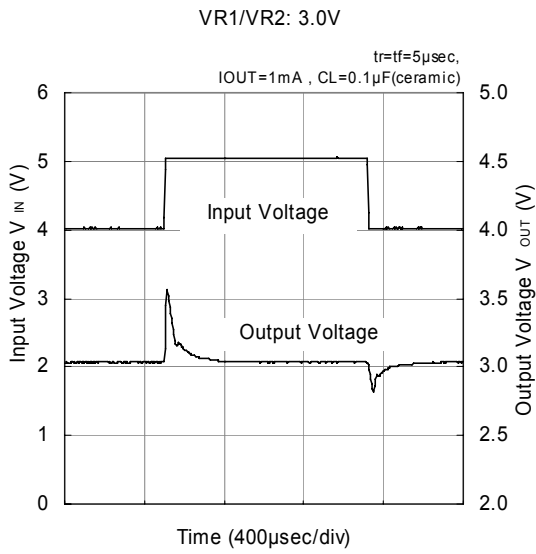

TYPICAL PERFORMANCE CHARACTERISTICS (Continued)

www.DataSheet4U.com

(8) Input Transient Response (Continued)

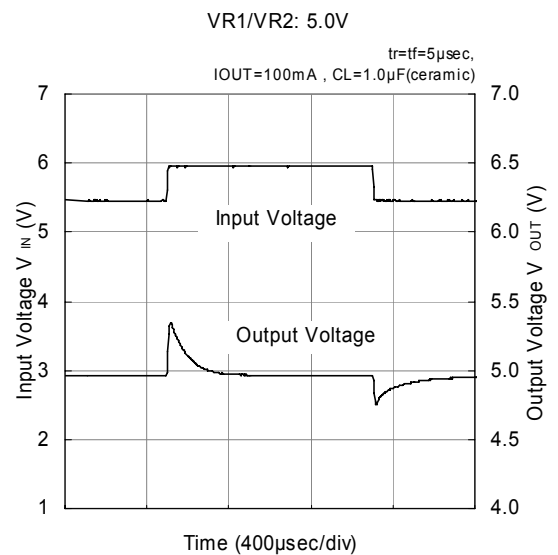
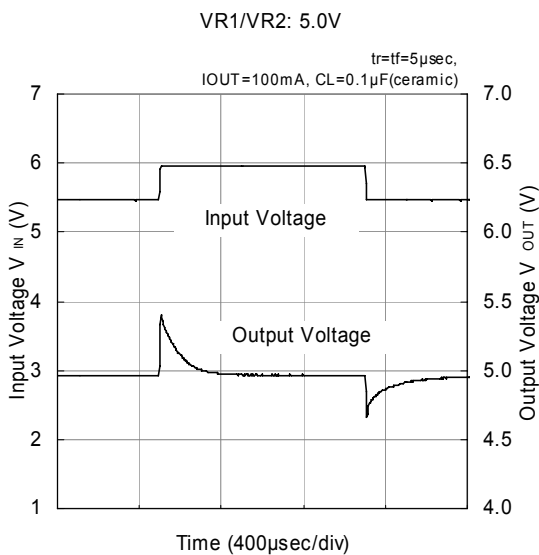
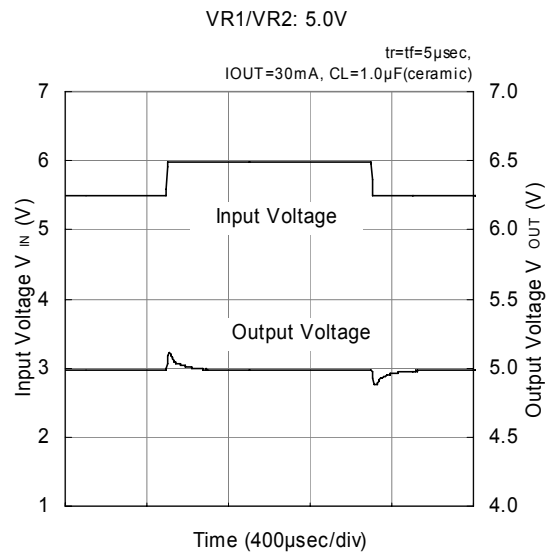
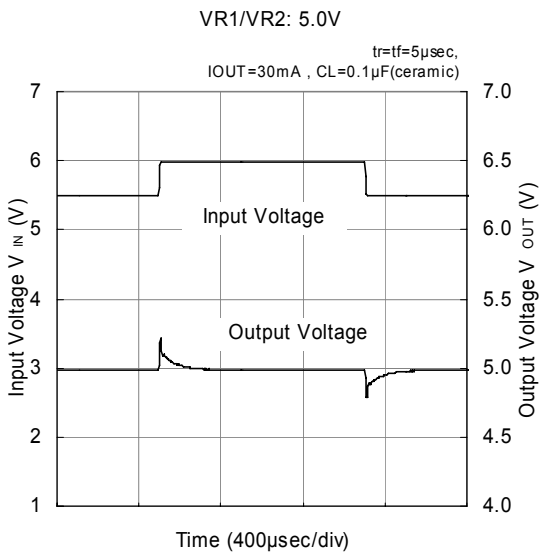
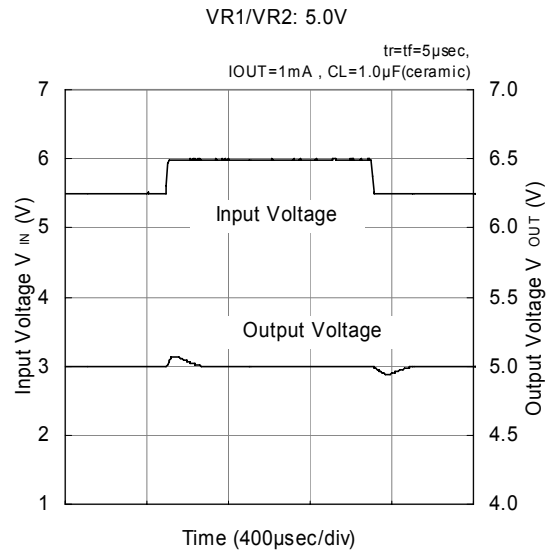
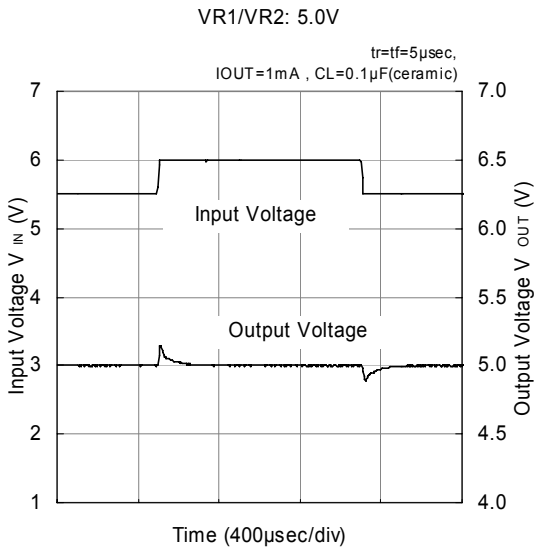

TYPICAL PERFORMANCE CHARACTERISTICS (Continued)

www.DataSheet4U.com

(9) Load Transient Response

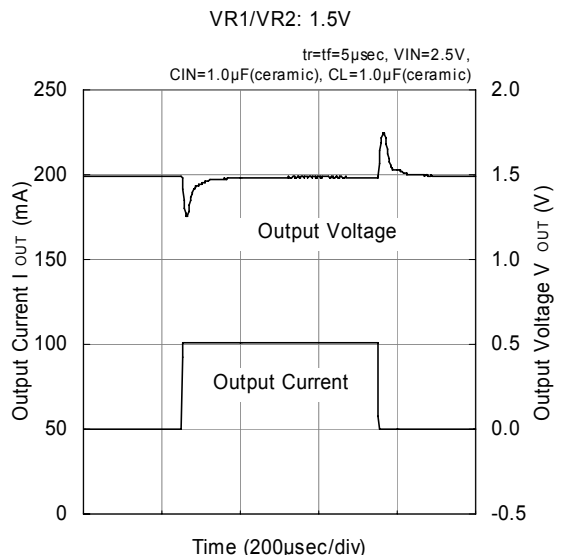
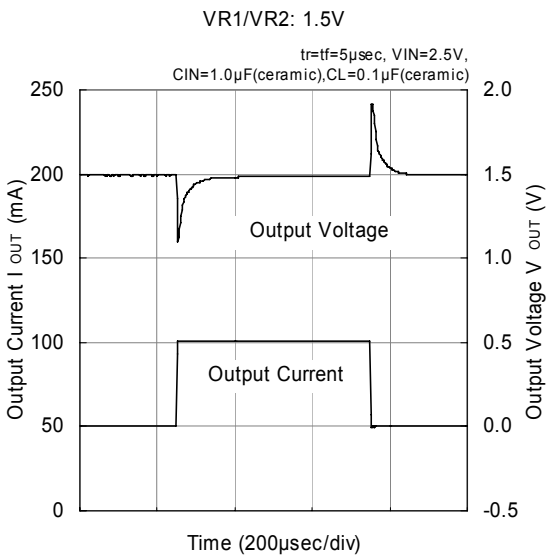
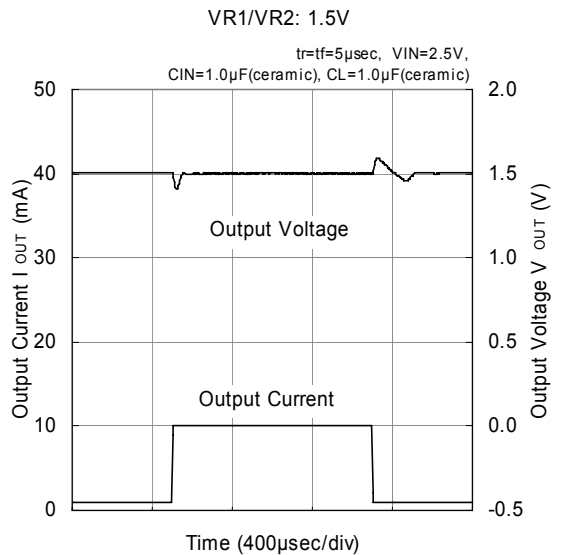
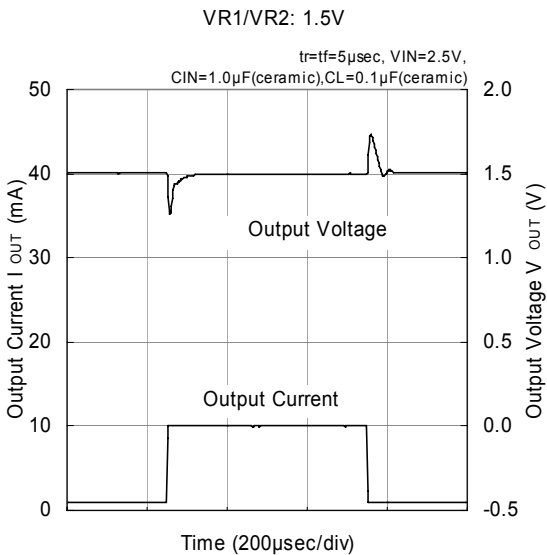
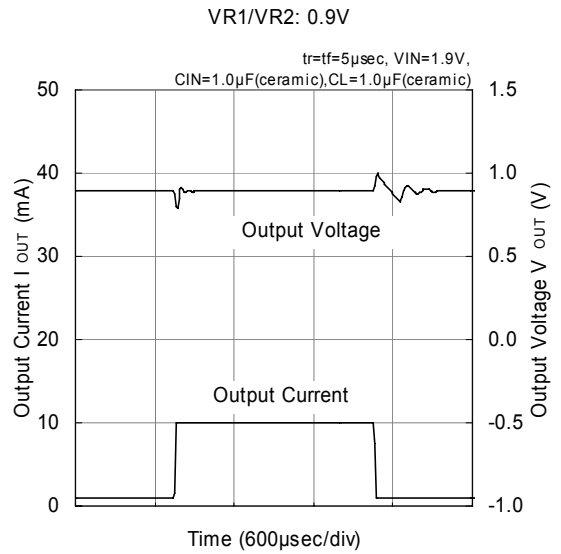
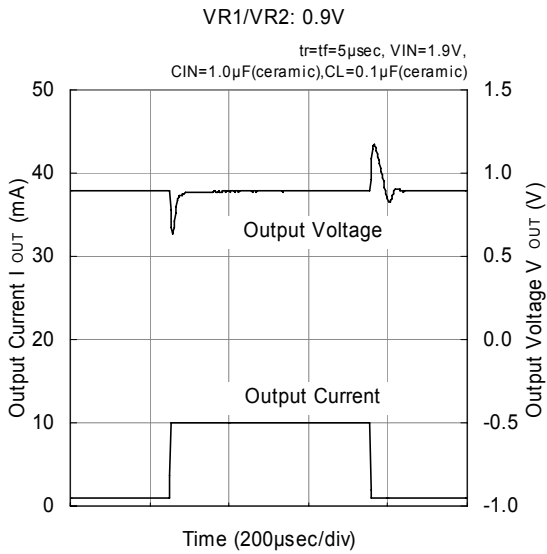

TYPICAL PERFORMANCE CHARACTERISTICS (Continued)

www.DataSheet4U.com

(9) Load Transient Response (Continued)

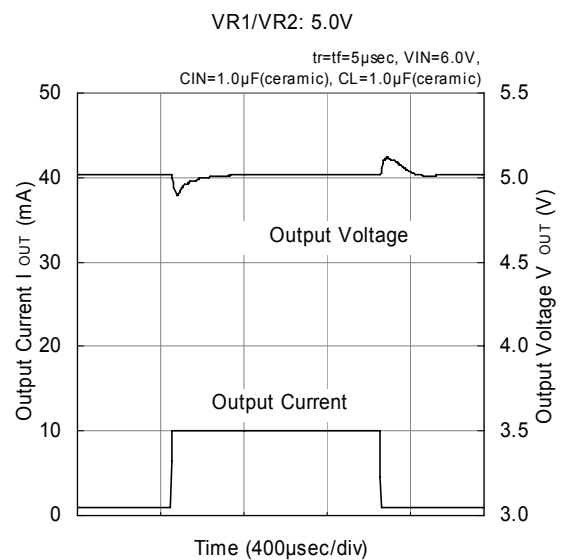
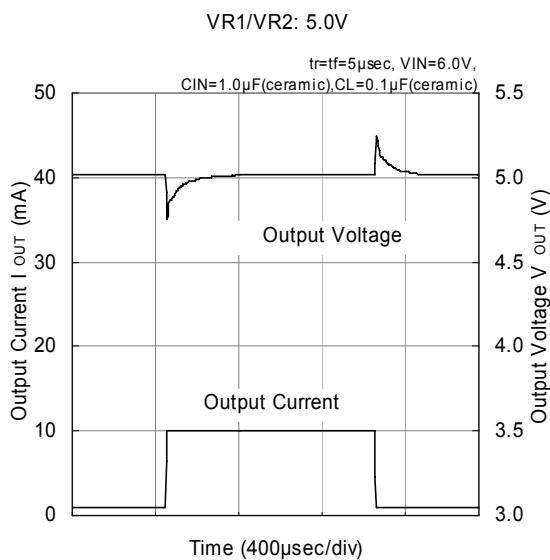
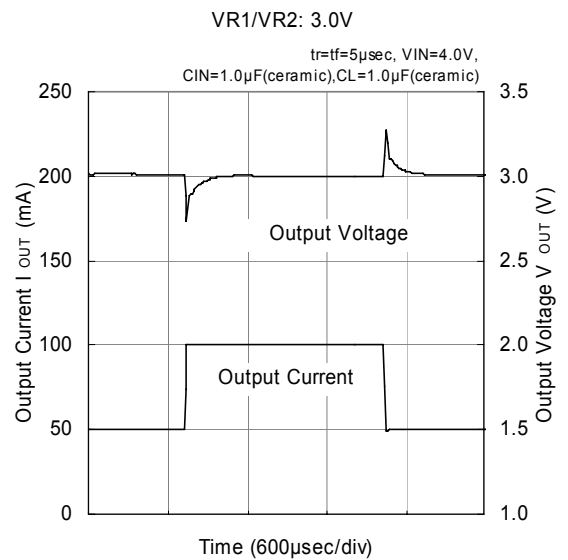
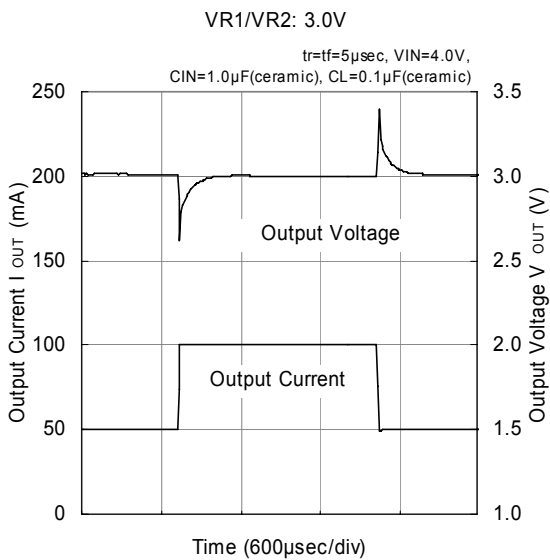
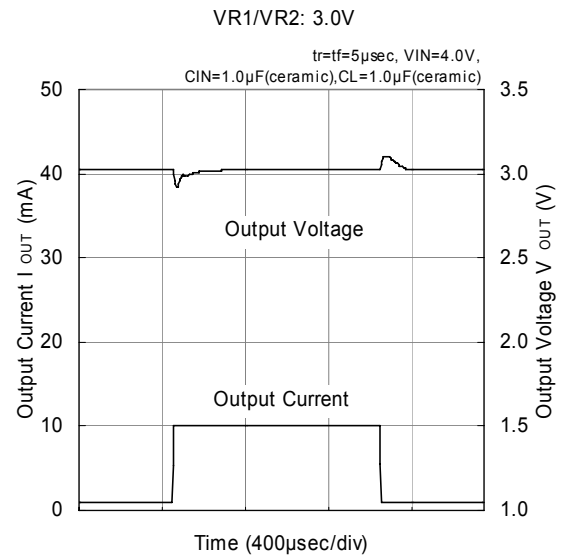
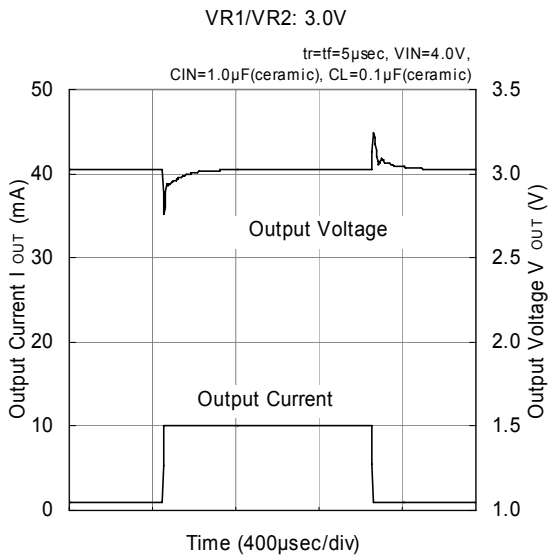

TYPICAL PERFORMANCE CHARACTERISTICS (Continued)

www.DataSheet4U.com

(9) Load Transient Response (Continued)

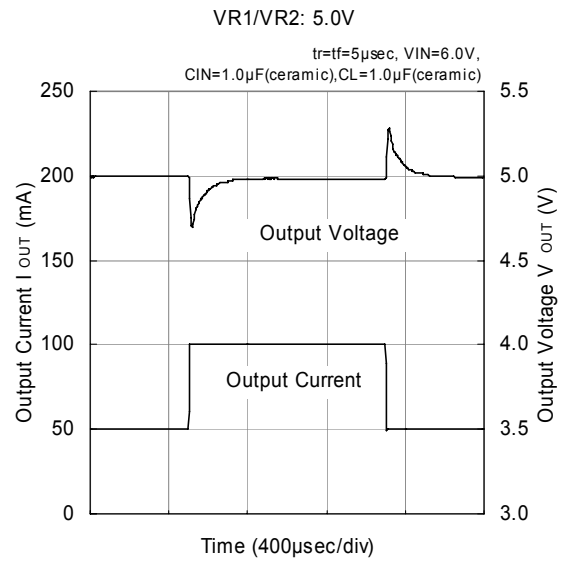
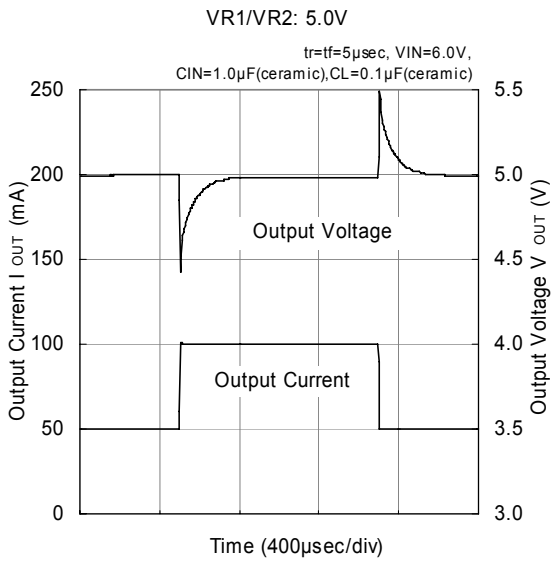

(10) Rising Response Time

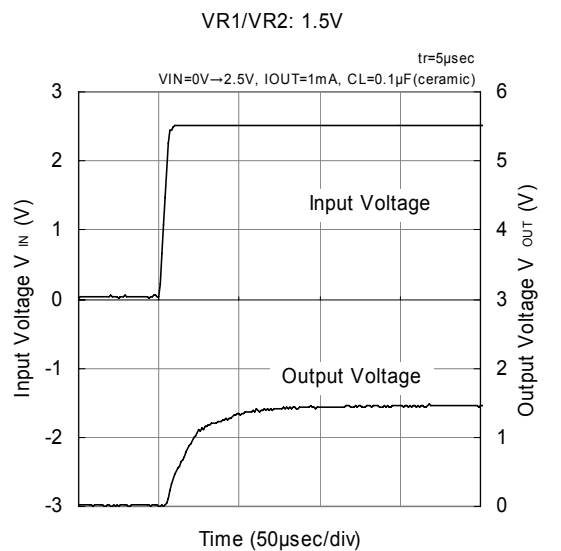
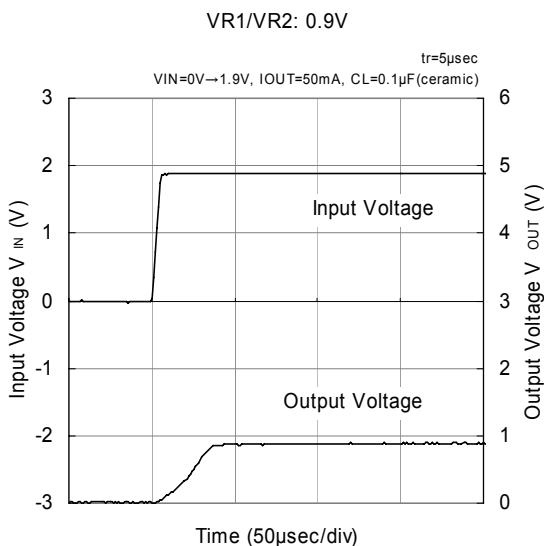
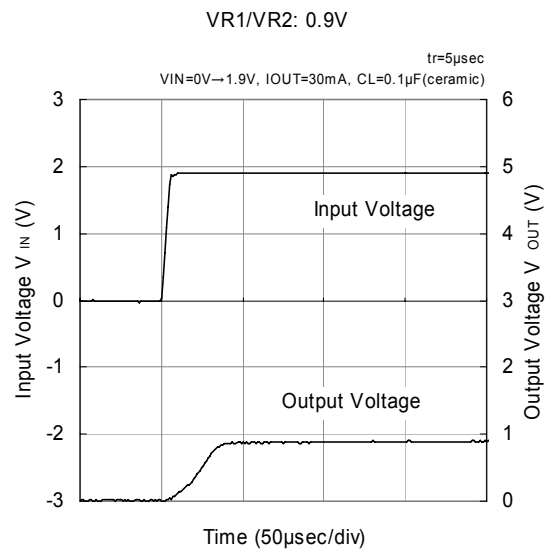
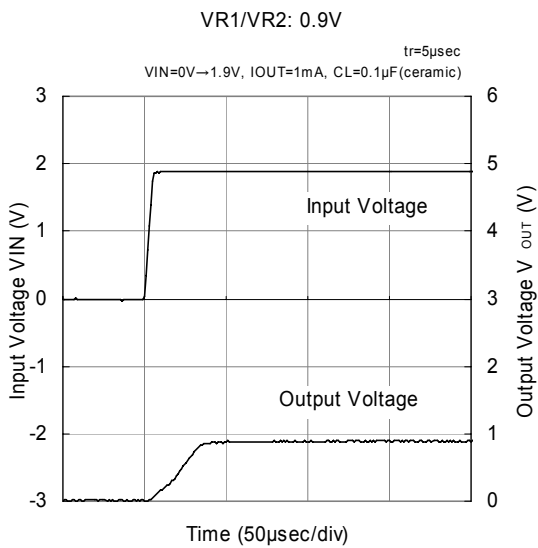

TYPICAL PERFORMANCE CHARACTERISTICS (Continued)

www.DataSheet4U.com

(10) Rising Response Time (Continued)

VR1/VR2: 1.5V

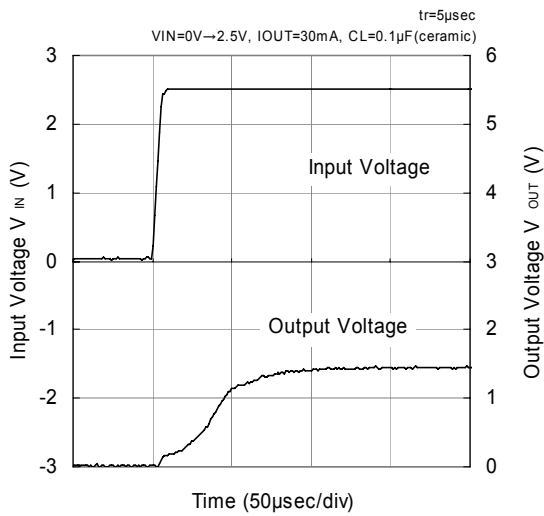

VR1/VR2: 1.5V

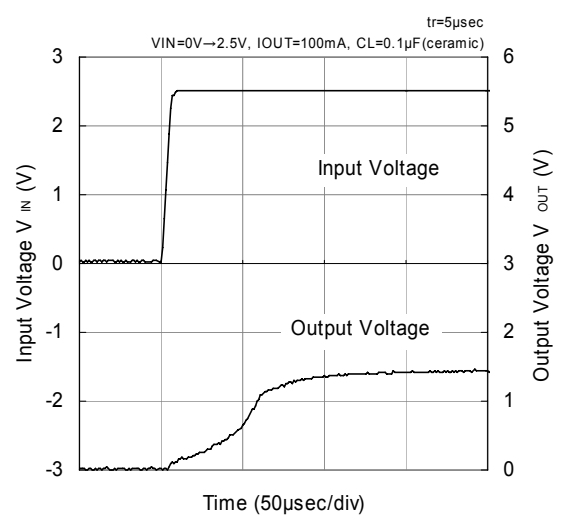

VR1/VR2: 3.0V

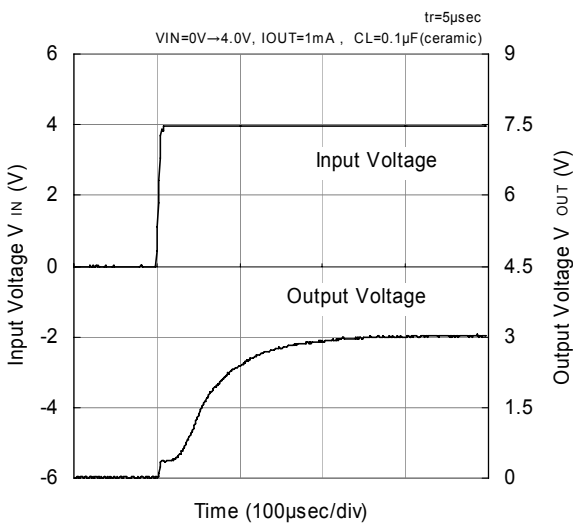

VR1/VR2: 3.0V

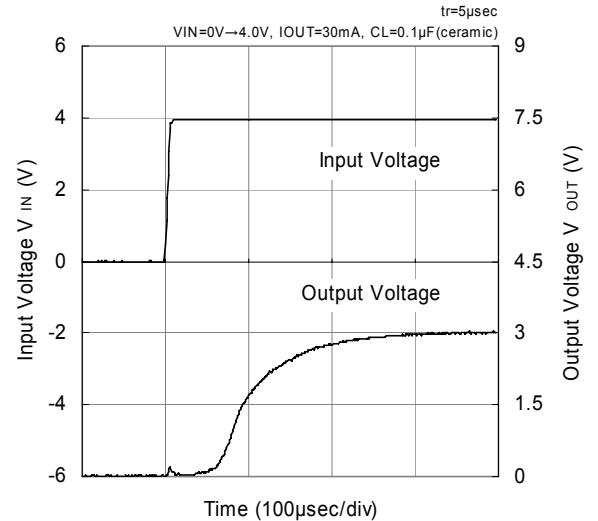

VR1/VR2: 3.0V

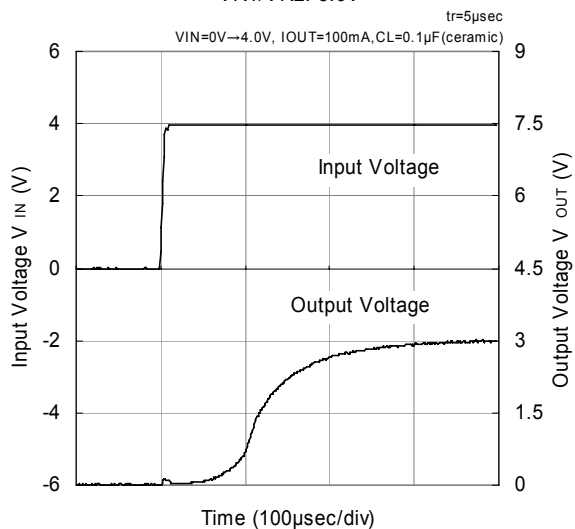

VR1/VR2: 5.0V

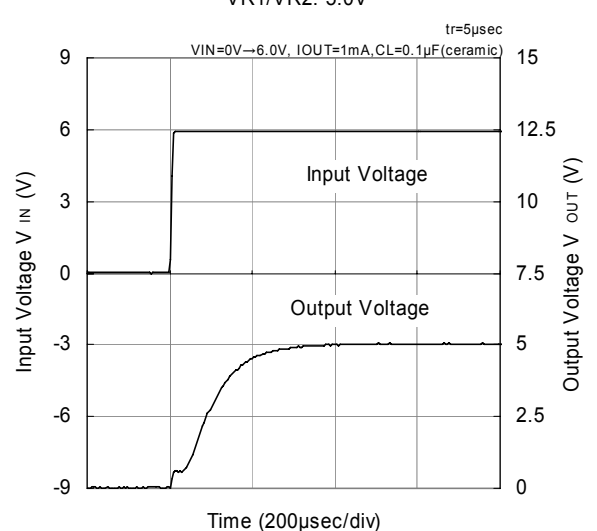

TYPICAL PERFORMANCE CHARACTERISTICS (Continued)

www.DataSheet4U.com

(10) Rising Response Time (Continued)

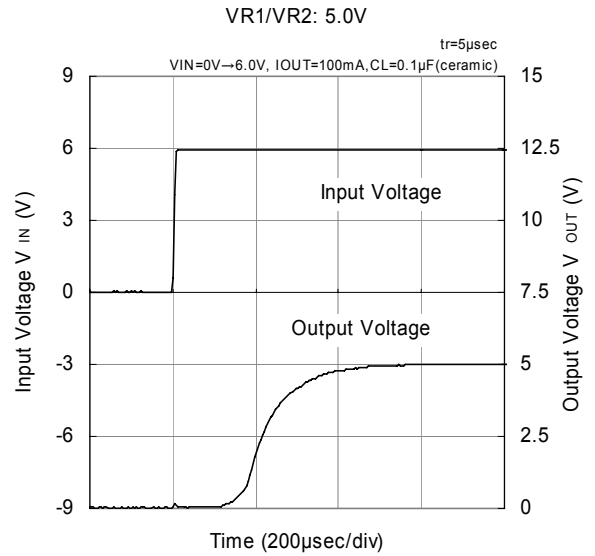
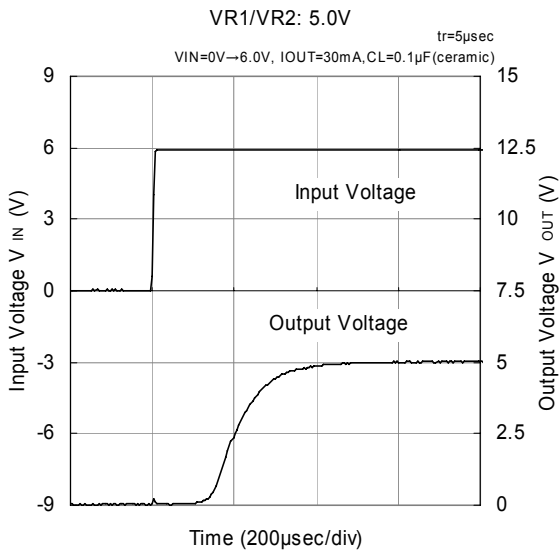

(11) EN2 Rising Response Time (For XC6412 series)

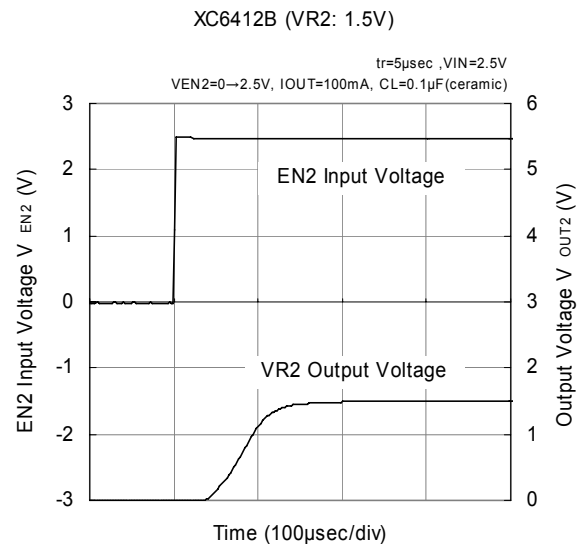
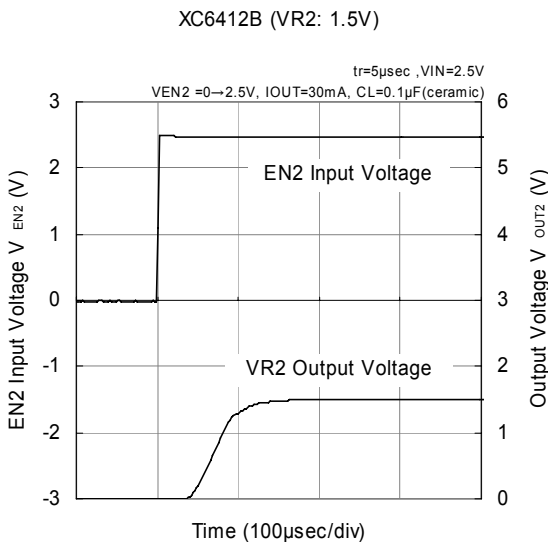
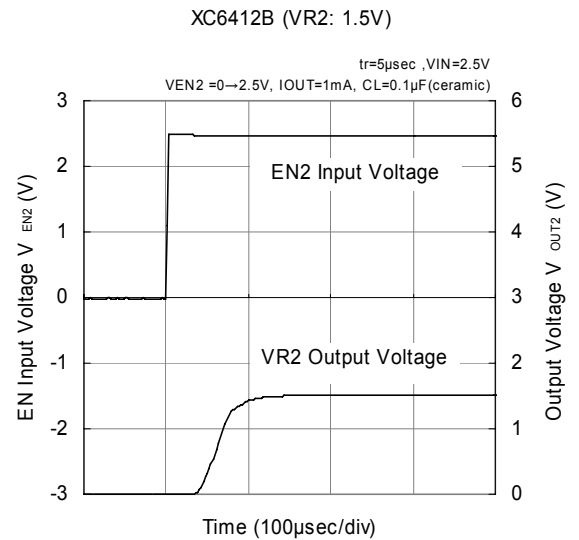
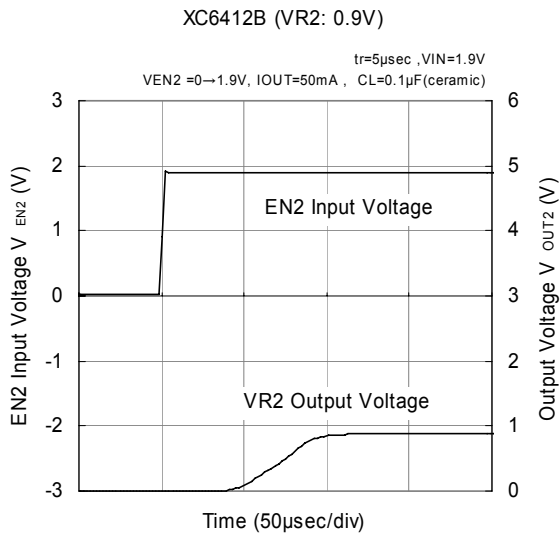

TYPICAL PERFORMANCE CHARACTERISTICS (Continued)

www.DataSheet4U.com

(11) EN2 Rising Response Time (For XC6412 series) (Continued)

XC6412B (VR2: 1.5V)

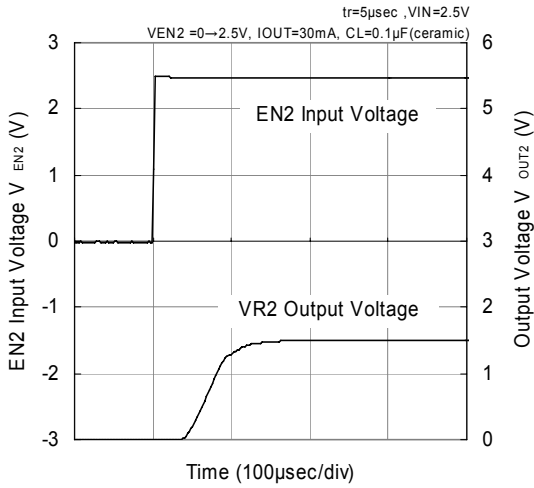

XC6412B (VR2: 1.5V)

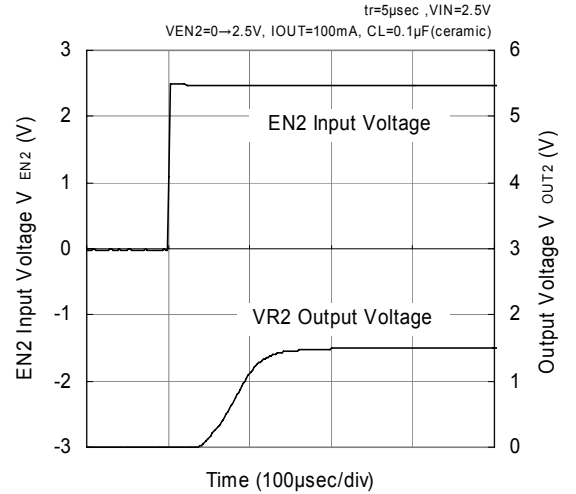

XC6412B (VR2: 3.0V)

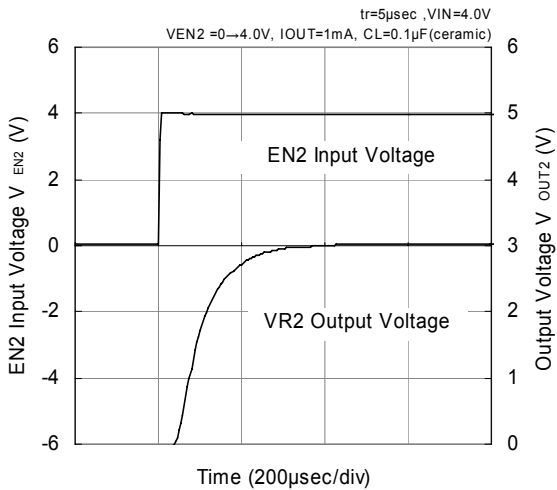

XC6412B (VR2: 3.0V)

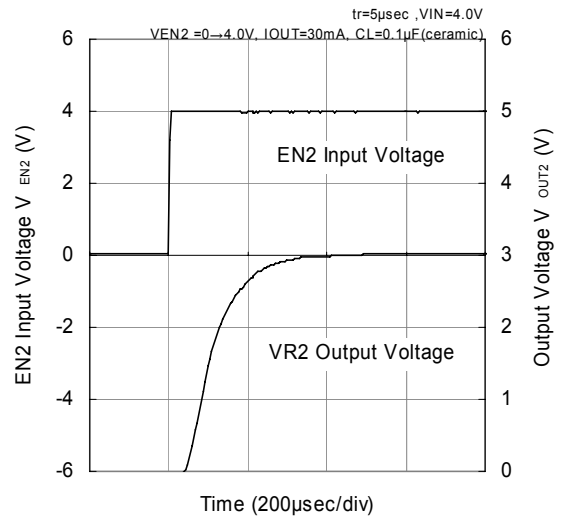

XC6412B (VR2: 3.0V)

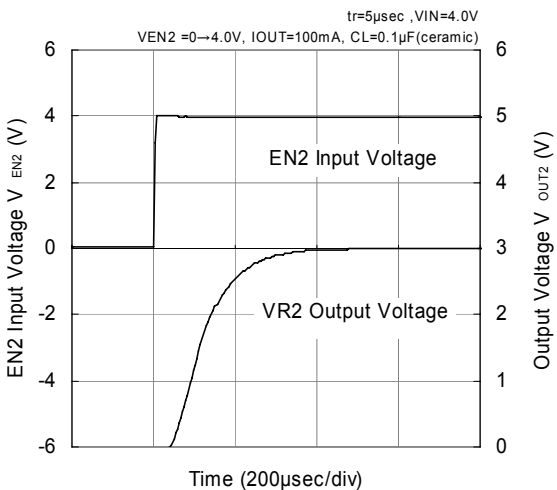

XC6412B (VR2: 5.0V)

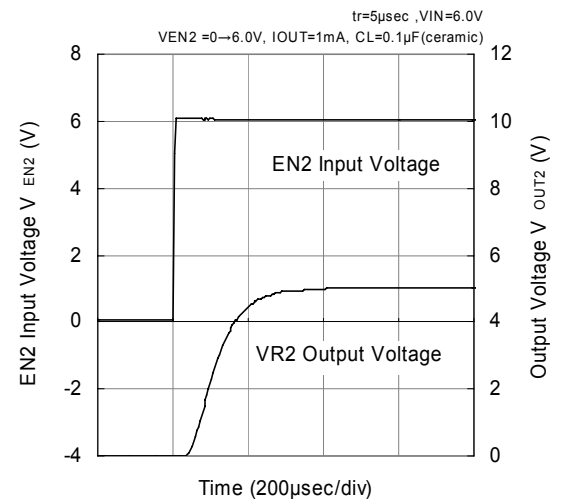

TYPICAL PERFORMANCE CHARACTERISTICS (Continued)

www.DataSheet4U.com

(11) EN2 Rising Response Time (For XC6412 series)

XC6412B (VR2: 5.0V)

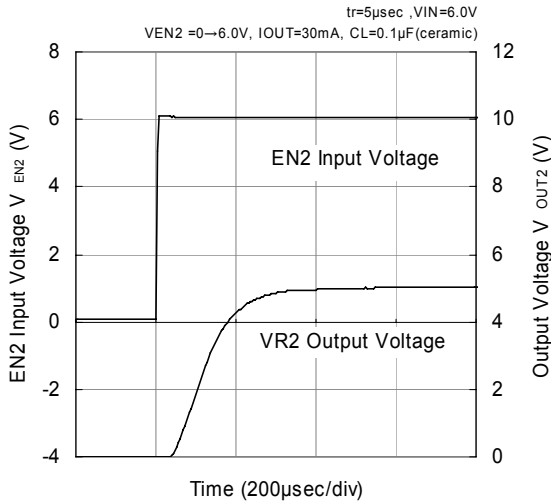

XC6412B (VR2: 5.0V)

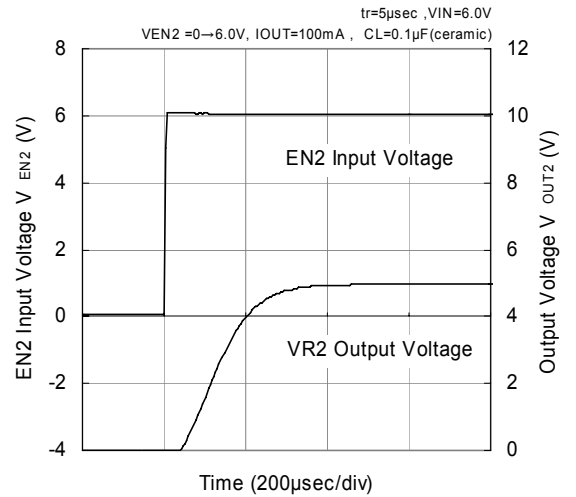

(12) Ripple Rejection Rate

VR1/VR2: 0.9V

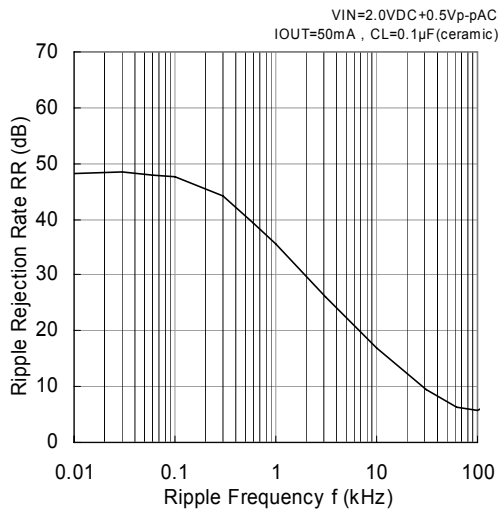

VR1/VR2: 1.5V

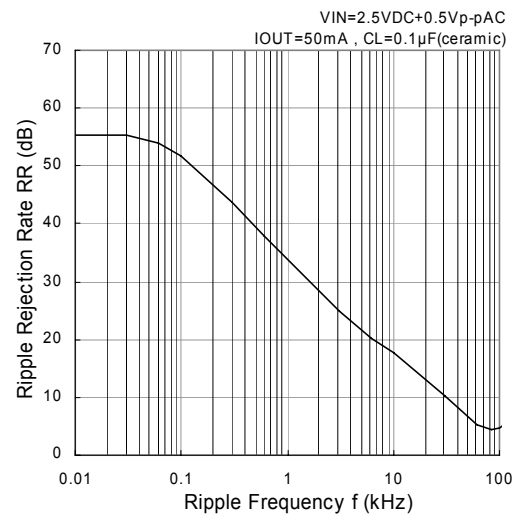

VR1/VR2: 3.0V

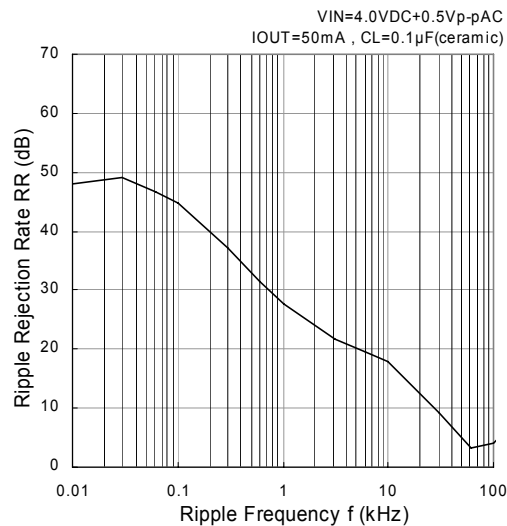

VR1/VR2: 5.0V

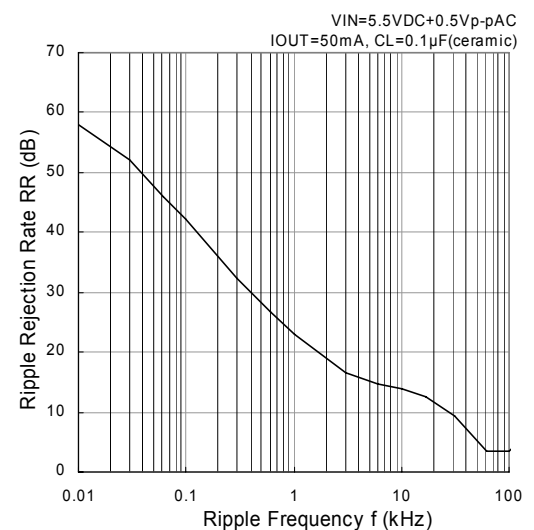

PACKAGING INFORMATION

● SOT-25

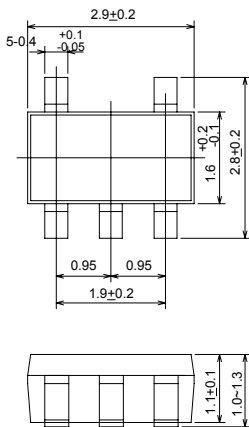

● SOT-26

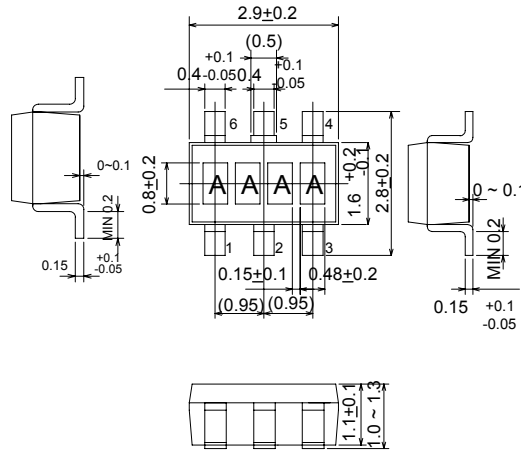

● USP-6C

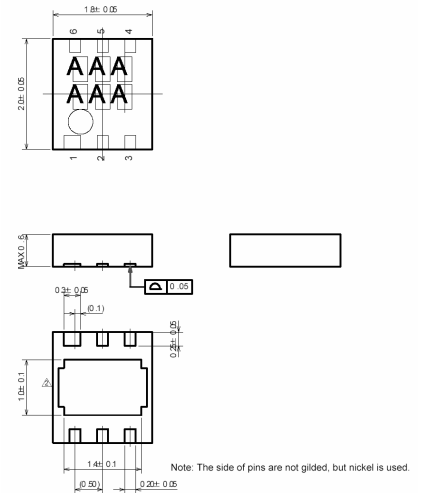

● USP-6C Recommended Pattern Layout

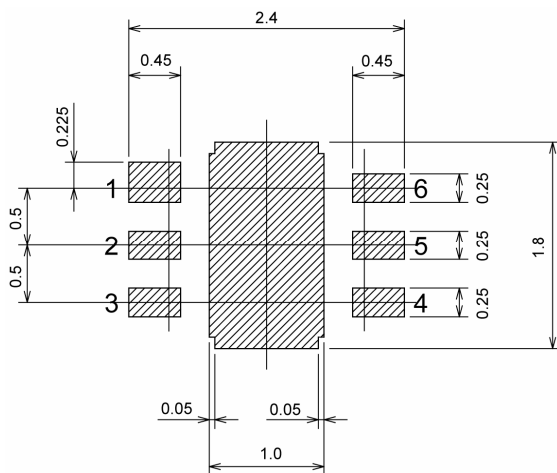

● USP-6C Recommended Metal Mask Design

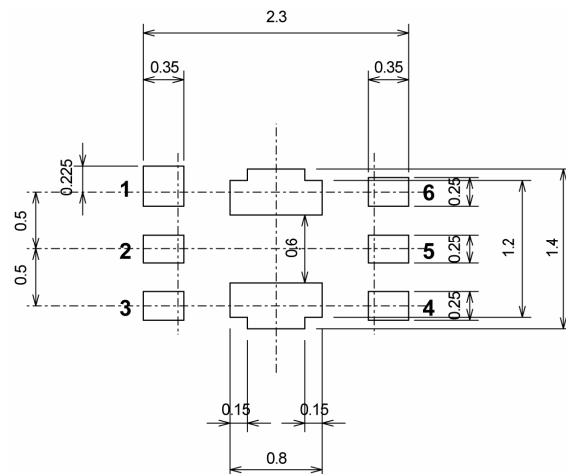

1. The products and product specifications contained herein are subject to change without notice to improve performance characteristics. Consult us, or our representatives before use, to confirm that the information in this catalog is up to date.
2. We assume no responsibility for any infringement of patents, patent rights, or other rights arising from the use of any information and circuitry in this catalog.
3. Please ensure suitable shipping controls (including fail-safe designs and aging protection) are in force for equipment employing products listed in this catalog.
4. The products in this catalog are not developed, designed, or approved for use with such equipment whose failure of malfunction can be reasonably expected to directly endanger the life of, or cause significant injury to, the user.
(e.g. Atomic energy; aerospace; transport; combustion and associated safety equipment thereof.)
5. Please use the products listed in this catalog within the specified ranges.
Should you wish to use the products under conditions exceeding the specifications, please consult us or our representatives.
6. We assume no responsibility for damage or loss due to abnormal use.
7. All rights reserved. No part of this catalog may be copied or reproduced without the prior permission of Torex Semiconductor Ltd.

TOREX SEMICONDUCTOR LTD.