

# NL7SZ98

## Configurable Multifunction Gate

The NL7SZ98 is an advanced high-speed CMOS multifunction gate. The device allows the user to choose logic functions MUX, AND, OR, NAND, NOR, INVERT and BUFFER. The device has Schmitt-trigger inputs, thereby enhancing noise immunity.

The NL7SZ98 input and output structures provide protection when voltages up to 7.0 V are applied, regardless of the supply voltage.

### Features

- High Speed:  $t_{PD} = 3.4 \text{ ns (Typ) @ } V_{CC} = 5.0 \text{ V}$
- Low Power Dissipation:  $I_{CC} = 1 \mu\text{A (Maximum) at } T_A = 25^\circ\text{C}$
- Power Down Protection Provided on inputs
- Balanced Propagation Delays
- Overvoltage Tolerant (OVT) Input and Output Pins
- Ultra-Small Package
- This is a Pb-Free Device



**ON Semiconductor®**

<http://onsemi.com>



1

**SC-88 (SOT-363)  
CASE 419B**

### MARKING DIAGRAM

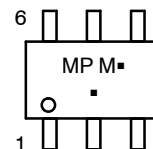

MP = Specific Device Code  
M = Date Code  
▪ = Pb-Free Package

(Note: Microdot may be in either location)

### PIN ASSIGNMENTS

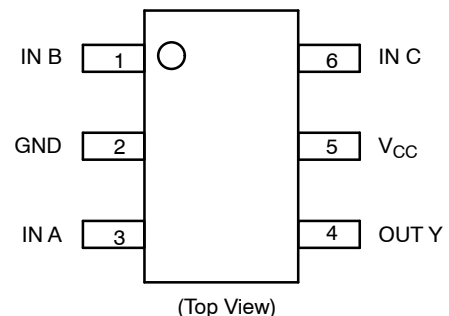

(Top View)

### ORDERING INFORMATION

See detailed ordering and shipping information in the package dimensions section on page 7 of this data sheet.

# NL7SZ98

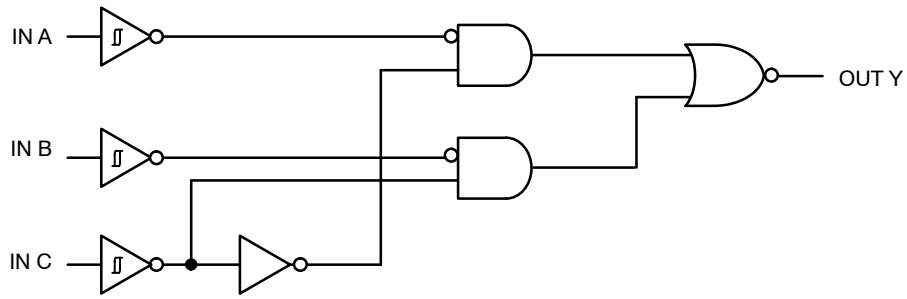

Figure 1. Function Diagram

## PIN ASSIGNMENT

1	IN B
2	GND
3	IN A
4	OUT Y
5	V <sub>CC</sub>
6	IN C

## FUNCTION TABLE\*

Input			Output
A	B	C	Y
L	L	L	H
L	L	H	H
L	H	L	L
L	H	H	H
H	L	L	H
H	L	H	L
H	H	L	L
H	H	H	L

\*To select a logic function, please refer to "Logic Configurations section".

# NL7SZ98

## LOGIC CONFIGURATIONS

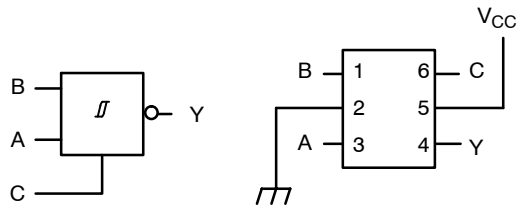

Figure 2. 2-Input MUX with Output Inverted

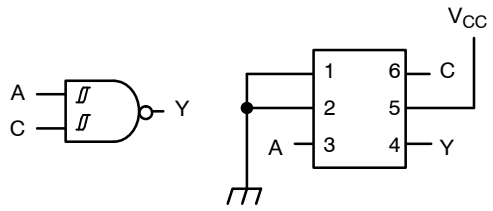

Figure 3. 2-Input NAND (When B = "L")

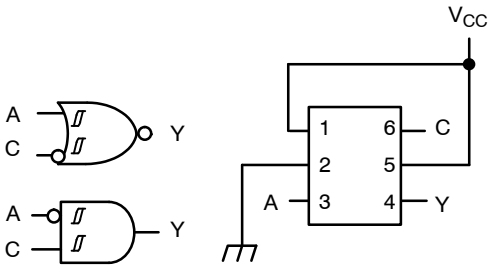

Figure 4. 2-Input NOR with Input C Inverted (When B = "H")

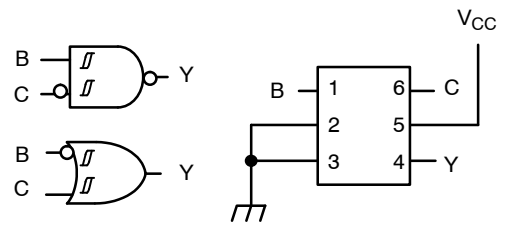

Figure 5. 2-Input NAND with Input C Inverted (When A = "L")

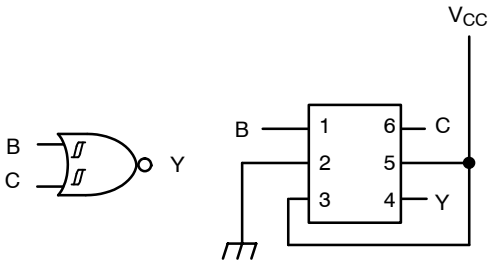

Figure 6. 2-Input NOR (When A = "H")

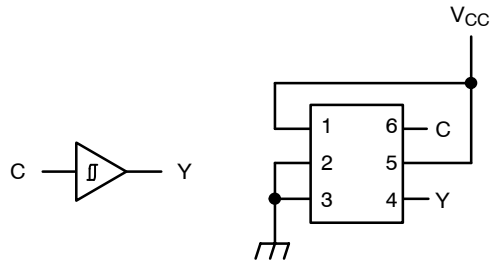

Figure 7. Buffer (When A = "L" and B = "H")

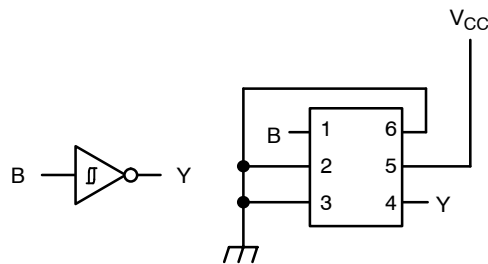

Figure 8. Inverter (When A = C = "L")

# NL7SZ98

## MAXIMUM RATINGS

Symbol	Parameter	Value	Unit
V <sub>CC</sub>	DC Supply Voltage	-0.5 to +7.0	V
V <sub>IN</sub>	DC Input Voltage	-0.5 to +7.0	V
V <sub>OUT</sub>	DC Output Voltage	-0.5 to +7.0	V
I <sub>IK</sub>	DC Input Diode Current V <sub>IN</sub> < GND	-50	mA
I <sub>OK</sub>	DC Output Diode Current V <sub>OUT</sub> < GND	-50	mA
I <sub>O</sub>	DC Output Source/Sink Current	± 50	mA
I <sub>CC</sub>	DC Supply Current Per Supply Pin	± 100	mA
I <sub>GND</sub>	DC Ground Current per Ground Pin	± 100	mA
T <sub>STG</sub>	Storage Temperature Range	-65 to +150	°C
T <sub>L</sub>	Lead Temperature, 1 mm from Case for 10 Seconds	260	°C
T <sub>J</sub>	Junction Temperature Under Bias	+150	°C
θ <sub>JA</sub>	Thermal Resistance (Note 1) SC-88	350	°C/W
P <sub>D</sub>	Power Dissipation in Still Air at 85°C SC-88	200	mW
MSL	Moisture Sensitivity	Level 1	
F <sub>R</sub>	Flammability Rating Oxygen Index: 28 to 34	UL 94 V-0 @ 0.125 in	
V <sub>ESD</sub>	ESD Withstand Voltage Human Body Mode (Note 2) Machine Model (Note 3) Charged Device Model (Note 4)	>2000 >200 N/A	V
I <sub>LATCHUP</sub>	Latchup Performance Above V <sub>CC</sub> and Below GND at 125°C (Note 5)	± 500	mA

Stresses exceeding Maximum Ratings may damage the device. Maximum Ratings are stress ratings only. Functional operation above the Recommended Operating Conditions is not implied. Extended exposure to stresses above the Recommended Operating Conditions may affect device reliability.

1. Measured with minimum pad spacing on an FR4 board, using 10 mm by 1 inch, 2 ounce copper trace no air flow.
2. Tested to EIA/JESD22-A114-A.
3. Tested to EIA/JESD22-A115-A.
4. Tested to JESD22-C101-A.
5. Tested to EIA/JESD78.

## RECOMMENDED OPERATING CONDITIONS

Symbol	Parameter	Min	Max	Unit
V <sub>CC</sub>	Positive DC Supply Voltage	1.65	5.5	V
V <sub>IN</sub>	Digital Input Voltage	0	5.5	V
V <sub>OUT</sub>	Output Voltage	0	5.5	V
T <sub>A</sub>	Operating Free-Air Temperature	-55	+125	°C
Δt/ΔV	Input Transition Rise or Fall Rate V <sub>CC</sub> = 2.5 V ± 0.2 V V <sub>CC</sub> = 3.3 V ± 0.3 V V <sub>CC</sub> = 5.0 V ± 0.5 V	0 0 0	No Limit No Limit No Limit	nS/V

# NL7SZ98

## DC ELECTRICAL CHARACTERISTICS

Symbol	Parameter	Conditions	V <sub>CC</sub> (V)	T <sub>A</sub> = 25°C			T <sub>A</sub> ≤ +85°C		T <sub>A</sub> = -55°C to +125°C		Unit
				Min	Typ	Max	Min	Max	Min	Max	
V <sub>T+</sub>	Positive Threshold Voltage		1.65	0.79		1.16		1.16		1.16	V
			2.3	1.11		1.56		1.56		1.56	
			3.0	1.5		1.87		1.87		1.87	
			4.5	2.16		2.74		2.74		2.74	
			5.5	2.61		3.33		3.33		3.33	
V <sub>T-</sub>	Negative Threshold Voltage		1.65	0.35		0.62	0.35		0.35		V
			2.3	0.58		0.87	0.58		0.58		
			3.0	0.84		1.19	0.84		0.84		
			4.5	1.41		1.9	1.41		1.41		
			5.5	1.78		2.29	1.78		1.78		
V <sub>H</sub>	Hysteresis Voltage		1.65	0.30		0.62	0.30	0.62	0.30	0.62	V
			2.3	0.40		0.8	0.40	0.8	0.40	0.8	
			3.0	0.53		0.87	0.53	0.87	0.53	0.87	
			4.5	0.71		1.04	0.71	1.04	0.71	1.04	
			5.5	0.8		1.2	0.8	1.2	0.8	1.2	
V <sub>OH</sub>	Minimum High-Level Output Voltage	V <sub>IN</sub> ≤ V <sub>T-MIN</sub> I <sub>OH</sub> = -50 μA	1.65 – 5.5	V <sub>CC</sub> – 0.1			V <sub>CC</sub> – 0.1		V <sub>CC</sub> – 0.1		V
		V <sub>IN</sub> ≤ V <sub>T-MIN</sub>									
		I <sub>OH</sub> = -4 mA	1.65	1.2			1.2		1.2		
		I <sub>OH</sub> = -8 mA	2.3	1.9			1.9		1.9		
		I <sub>OH</sub> = -16 mA	3.0	2.4			2.4		2.4		
		I <sub>OH</sub> = -24 mA	3.0	2.3			2.3		2.3		
		I <sub>OH</sub> = -32 mA	4.5	3.8			3.8		3.8		
V <sub>OL</sub>	Maximum Low-Level Output Voltage	V <sub>IN</sub> ≥ V <sub>T+MAX</sub> I <sub>OL</sub> = 50 μA	1.65 – 5.5			0.1		0.1		0.1	V
		V <sub>IN</sub> ≥ V <sub>T+MAX</sub>									
		I <sub>OL</sub> = 4 mA	1.65			0.45		0.45		0.45	
		I <sub>OL</sub> = 8 mA	2.3			0.3		0.3		0.3	
		I <sub>OL</sub> = 16 mA	3.0			0.4		0.4		0.4	
		I <sub>OL</sub> = 24 mA	3.0			0.55		0.55		0.55	
		I <sub>OL</sub> = 32 mA	4.5			0.55		0.55		0.55	
I <sub>IN</sub>	Input Leakage Current	0 ≤ V <sub>IN</sub> ≤ 5.5 V	0 to 5.5			±0.1		±1.0		±1.0	μA
I <sub>CC</sub>	Quiescent Supply Current	0 ≤ V <sub>IN</sub> ≤ V <sub>CC</sub>	5.5			1.0		10		10	μA

# NL7SZ98

## AC ELECTRICAL CHARACTERISTICS (Input $t_r = t_f = 3.0$ ns)

Symbol	Parameter	$V_{CC}$ (V)	Test Condition	$T_A = 25^\circ\text{C}$			$T_A \leq +85^\circ\text{C}$		$T_A = -55^\circ\text{C}$ to $+125^\circ\text{C}$		Unit
				Min	Typ	Max	Min	Max	Min	Max	
$t_{PLH}$ , $t_{PHL}$	Propagation Delay, Any Input to Output Y (See Test Circuit)	1.65 – 1.95		3.2	8.9	14.4	3.2	14.4	3.2	14.4	ns
				2.0	5.2	8.3	2.0	8.3	2.0	8.3	
				1.5	4.0	6.3	1.5	6.3	1.5	6.3	
				1.1	3.4	5.1	1.1	5.1	1.1	5.1	
$C_{IN}$	Input Capacitance				3.5						pF
$C_{PD}$	Power Dissipation Capacitance (Note 6)	5.0	$f = 10$ MHz		22						pF

6.  $C_{PD}$  is defined as the value of the internal equivalent capacitance which is calculated from the dynamic operating current consumption without load. Average operating current can be obtained by the equation  $I_{CC(OPR)} = C_{PD} \cdot V_{CC} \cdot f_{in} + I_{CC}$ .  $C_{PD}$  is used to determine the no-load dynamic power consumption:  $P_D = C_{PD} \cdot V_{CC}^2 \cdot f_{in} + I_{CC} \cdot V_{CC}$ .

## TEST CIRCUIT AND VOLTAGE WAVEFORMS

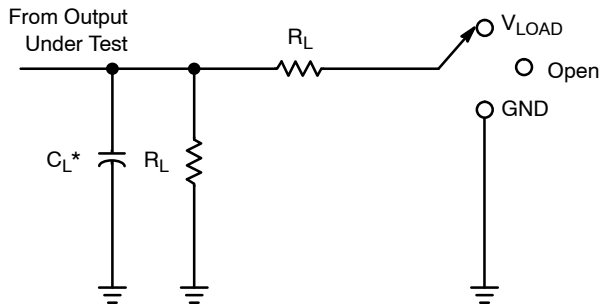

Test	S1
$t_{PLH}/t_{PHL}$	Open
$t_{PLZ}/t_{PZL}$	$V_{LOAD}$
$t_{PHZ}/t_{PZH}$	GND

\* $C_L$  includes probes and jig capacitance.

Figure 9. Load Circuit

$V_{CC}$	Inputs		$V_M$	$V_{LOAD}$	$C_L$	$R_L$	$V_\Delta$
	$V_I$	$t_r/t_f$					
$1.8\text{ V} \pm 0.15\text{ V}$	$V_{CC}$	$\leq 2\text{ ns}$	$V_{CC}/2$	$2 \times V_{CC}$	30 pF	1 k $\Omega$	0.15 V
$2.5\text{ V} \pm 0.2\text{ V}$	$V_{CC}$	$\leq 2\text{ ns}$	$V_{CC}/2$	$2 \times V_{CC}$	30 pF	500 $\Omega$	0.15 V
$3.3\text{ V} \pm 0.3\text{ V}$	3 V	$\leq 2.5\text{ ns}$	1.5 V	6 V	50 pF	500 $\Omega$	0.3 V
$5.5\text{ V} \pm 0.5\text{ V}$	$V_{CC}$	$\leq 2.5\text{ ns}$	$V_{CC}/2$	$2 \times V_{CC}$	50 pF	500 $\Omega$	0.3 V

# NL7SZ98

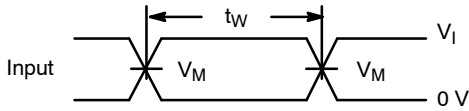

**Figure 10. Voltage Waveforms Pulse Duration**

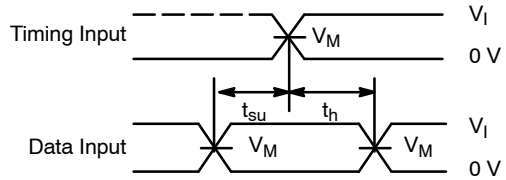

**Figure 11. Voltage Waveforms Setup and Hold Times**

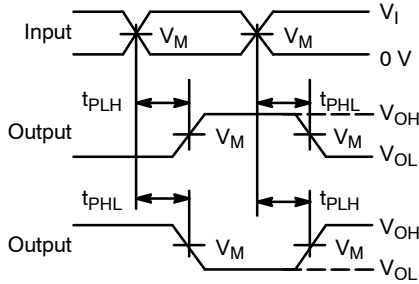

**Figure 12. Voltage Waveforms Propagation Delay Times Inverting and Noninverting Outputs**

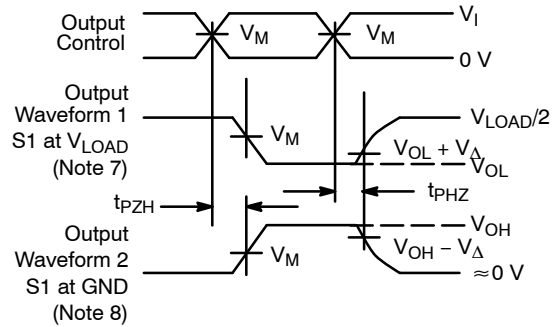

**Figure 13. Voltage Waveforms Enable and Disable Times Low- and High-Level Enabling**

7. Waveform 1 is for an output with internal conditions such that the output is low, except when disabled by the output control.
8. Waveform 2 is for an output with internal conditions such that the output is high, except when disabled by the output control
9. All input pulses are supplied by generators having the following characteristics:  $PRR \leq 10 \text{ MHz}$ ,  $Z_O = 50 \Omega$ .
10. The outputs are measured one at a time, with one transition per measurement.
11. All parameters are waveforms are not applicable to all devices.

## ORDERING INFORMATION

Device	Package	Shipping <sup>†</sup>
NL7SZ98DFT2G	SC-88 (Pb-Free)	3000 / Tape & Reel

<sup>†</sup>For information on tape and reel specifications, including part orientation and tape sizes, please refer to our Tape and Reel Packaging Specifications Brochure, BRD8011/D.

# NL7SZ98

## PACKAGE DIMENSIONS

SC-88/SC70-6/SOT-363  
CASE 419B-02  
ISSUE W

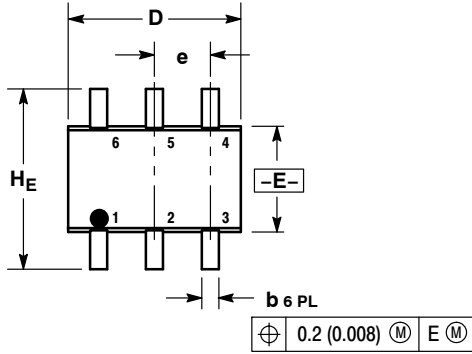

NOTES:

1. DIMENSIONING AND TOLERANCING PER ANSI Y14.5M, 1982.
2. CONTROLLING DIMENSION: INCH.
3. 419B-01 OBSOLETE, NEW STANDARD 419B-02.

DIM	MILLIMETERS			INCHES		
	MIN	NOM	MAX	MIN	NOM	MAX
A	0.80	0.95	1.10	0.031	0.037	0.043
A1	0.00	0.05	0.10	0.000	0.002	0.004
A3	0.20 REF			0.008 REF		
b	0.10	0.21	0.30	0.004	0.008	0.012
C	0.10	0.14	0.25	0.004	0.005	0.010
D	1.80	2.00	2.20	0.070	0.078	0.086
E	1.15	1.25	1.35	0.045	0.049	0.053
e	0.65 BSC			0.026 BSC		
L	0.10	0.20	0.30	0.004	0.008	0.012
HE	2.00	2.10	2.20	0.078	0.082	0.086

### SOLDERING FOOTPRINT\*

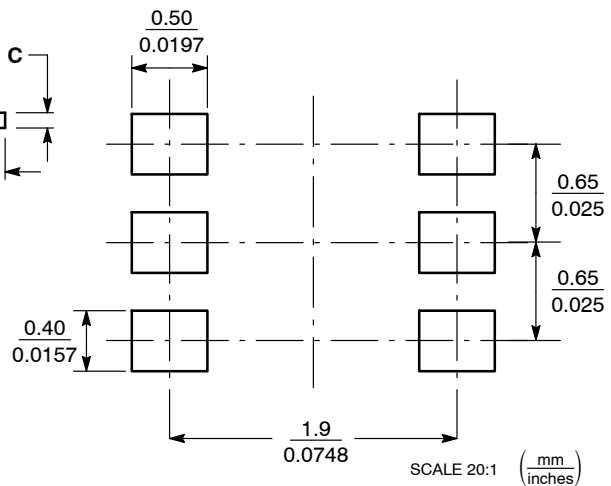

\*For additional information on our Pb-Free strategy and soldering details, please download the ON Semiconductor Soldering and Mounting Techniques Reference Manual, SOLDERRM/D.

ON Semiconductor and are registered trademarks of Semiconductor Components Industries, LLC (SCILLC). SCILLC reserves the right to make changes without further notice to any products herein. SCILLC makes no warranty, representation or guarantee regarding the suitability of its products for any particular purpose, nor does SCILLC assume any liability arising out of the application or use of any product or circuit, and specifically disclaims any and all liability, including without limitation special, consequential or incidental damages. "Typical" parameters which may be provided in SCILLC data sheets and/or specifications can and do vary in different applications and actual performance may vary over time. All operating parameters, including "Typicals" must be validated for each customer application by customer's technical experts. SCILLC does not convey any license under its patent rights nor the rights of others. SCILLC products are not designed, intended, or authorized for use as components in systems intended for surgical implant into the body, or other applications intended to support or sustain life, or for any other application in which the failure of the SCILLC product could create a situation where personal injury or death may occur. Should Buyer purchase or use SCILLC products for any such unintended or unauthorized application, Buyer shall indemnify and hold SCILLC and its officers, employees, subsidiaries, affiliates, and distributors harmless against all claims, costs, damages, and expenses, and reasonable attorney fees arising out of, directly or indirectly, any claim of personal injury or death associated with such unintended or unauthorized use, even if such claim alleges that SCILLC was negligent regarding the design or manufacture of the part. SCILLC is an Equal Opportunity/Affirmative Action Employer. This literature is subject to all applicable copyright laws and is not for resale in any manner.

### PUBLICATION ORDERING INFORMATION

**LITERATURE FULFILLMENT:**  
Literature Distribution Center for ON Semiconductor  
P.O. Box 5163, Denver, Colorado 80217 USA  
Phone: 303-675-2175 or 800-344-3860 Toll Free USA/Canada  
Fax: 303-675-2176 or 800-344-3867 Toll Free USA/Canada  
Email: orderlit@onsemi.com

**N. American Technical Support:** 800-282-9855 Toll Free  
USA/Canada  
**Europe, Middle East and Africa Technical Support:**  
Phone: 421 33 790 2910  
**Japan Customer Focus Center**  
Phone: 81-3-5773-3850

**ON Semiconductor Website:** [www.onsemi.com](http://www.onsemi.com)  
**Order Literature:** <http://www.onsemi.com/orderlit>  
For additional information, please contact your local Sales Representative