

**DUAL VOLTAGE TRACKING REGULATOR**

**DESCRIPTION**

This circuit is a dual polarity tracking regulator designed to provide balanced positive and negative output voltages at currents up to 100mA. It is internally set for positive and negative 15 volt outputs but a single external adjustment can be used to change both outputs simultaneously from 10 to 23 volts. This device can be used with input voltages of up to  $\pm 35$  volts and also has provision for adjustable current limiting, and utilization at currents in excess of two amps with the aid of external power transistors. A built-in sensing circuit monitors junction temperature and shuts down the regulator above 170°C eliminating the user's need for concern about power dissipation under short circuit conditions. The SG1501A will operate over the military ambient temperature range of -55°C to 125°C, while the SG2501A, SG3501A, and SG4501 are designed for commercial applications of 0°C to 70°C.

**FEATURES**

- $\pm 15V$  tracking outputs
- Output currents to 100mA
- Internal thermal shutdown protection
- Precision line and load regulation
- 1% maximum temperature variation
- Adjustable current limit
- $\pm 35V$  inputs
- Output adjustable from  $\pm 10V$  to  $\pm 23V$

**HIGH RELIABILITY FEATURES - SG1501A**

- ◆ Available to MIL-STD-883
- ◆ SG level "S" processing available

**4**

**BLOCK DIAGRAM**

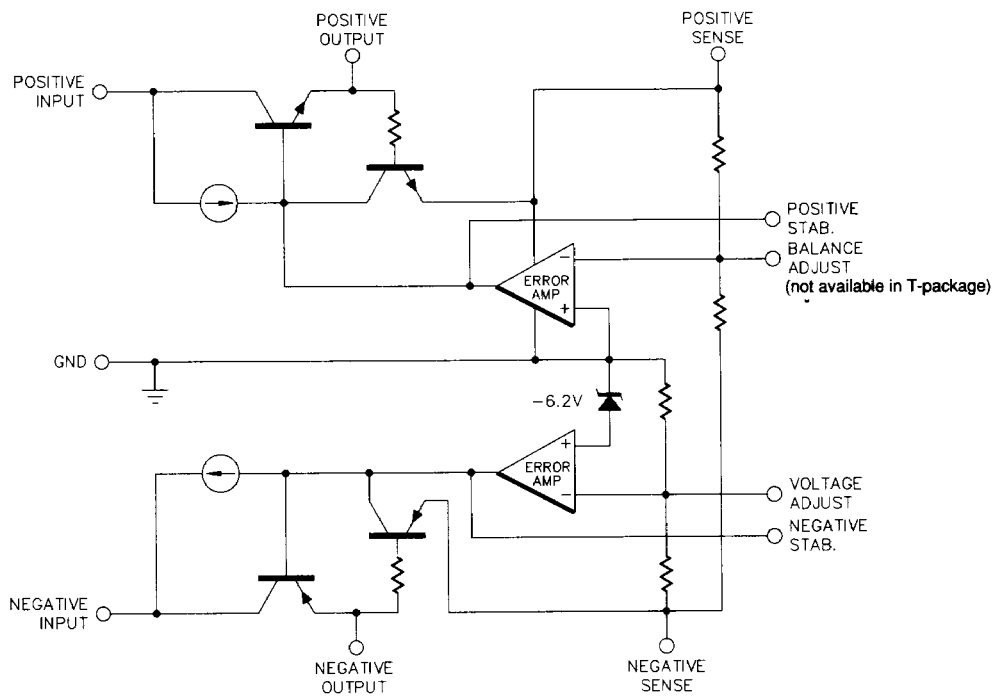

**ABSOLUTE MAXIMUM RATINGS** (Note 1)

Input Voltage from V+ to V-  
 SG1501A, SG2501A ..... 70V  
 SG3501A, SG4501 ..... 60V  
 Maximum Load Current ..... 100mA

Operating Junction Temperature  
 Hermetic (J, T, L - Packages) ..... 150°C  
 Plastic (N - Packages) ..... 150°C  
 Storage Temperature Range ..... -65°C to 150°C  
 Lead Temperature (Soldering, 10 Seconds) ..... 300°C

Note 1. Exceeding these ratings could cause damage to the device.

**THERMAL DERATING CURVES**

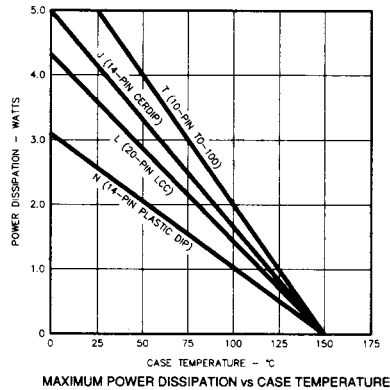
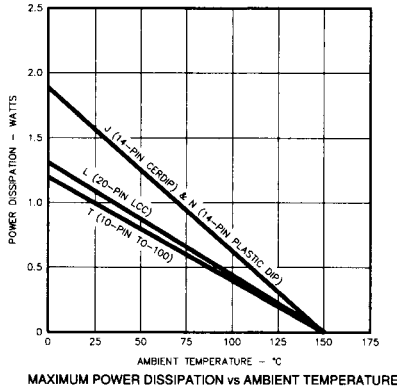

**RECOMMENDED OPERATING CONDITIONS** (Note 2)

Input Voltage from V+ to V-  
 SG1501A, SG2501A ..... 60V  
 SG3501A, 4501 ..... 50V  
 Output Current ..... 0 to 50mA

Input - Output Differential (minimum) ..... 4V  
 Operating Ambient Temperature Range ( $T_J$ )  
 SG1501A ..... -55°C to 125°C  
 SG2501A, SG3501A, SG4501 ..... 0°C to 70°C

Note 2. Range over which the device is functional.

**ELECTRICAL SPECIFICATIONS**

(Unless otherwise stated, these specifications apply for the operating ambient temperature of  $T_A = 25^\circ\text{C}$ ,  $V_{IN} = \pm 20\text{V}$ ,  $V_{OUT} = \pm 15\text{V}$ ,  $I_L = 0$ ,  $R_{SC} = 0\Omega$ ,  $C_1 = C_2 = 0.01\mu\text{F}$ ,  $C_3 = C_4 = 1.0\mu\text{F}$ , and VOLTAGE ADJUSTMENT pin open. All specifications apply to both positive and negative sides of the regulator, either singly or together. Low duty cycle pulse testing techniques are used which maintains junction and case temperatures equal to the ambient temperature.)

Parameter	Test Conditions	SG1501A/2501A			SG3501A			SG4501			Units
		Min.	Typ.	Max.	Min.	Typ.	Max.	Min.	Typ.	Max.	
Output Voltage		14.8	15	15.2	14.5	15	15.5	14.25		15.75	V
Input Voltage				$\pm 35$			$\pm 30$			$\pm 30$	V
Input - Output Differential		2			2			2			V
Output Voltage Balance	$R_{SC} = 0, I_L = 50\text{mA}$		50	150		50	300		50	300	mV
Line Regulation	$V_{IN} = 17\text{V to } V_{MAX}$ , $T_A = T_{MIN} \text{ to } T_{MAX}$		4	20		4	20		4	20	mV
Load Regulation	$I_L = 0\text{mA to } 50\text{mA}$ , $T_A = T_{MIN} \text{ to } T_{MAX}$		5	30		5	30		5	30	mV
Output Voltage Range	Voltage adjust circuit	10		23	10		23	10		23	V
Input Voltage Range	10V Output	12		35	12		30	12		30	V
Ripple Rejection	$f = 120\text{Hz}$		75			75			75		dB
Temperature Stability (Note 3)	$T_A = T_{MIN} \text{ to } T_{MAX}$		0.3	1.0		0.3	1.0		0.3	1.0	%
Short Circuit Current Limit	$R_{SC} = 10\Omega$		60			60			60		mA
Output Noise Voltage	$BW = 100\text{Hz to } 10\text{KHz}$		50			50			50		$\mu\text{V}_{rms}$
Positive Standby Current	$I_L = 0$		2	4		2	4		2	4	mA
Negative Standby Current	$I_L = 0$		3	5		3	5		3	5	mA
Long Term Stability			0.1			0.1			0.1		%/Khr

Note 3. These parameters, although guaranteed, are not tested in production.

CHARACTERISTIC CURVES

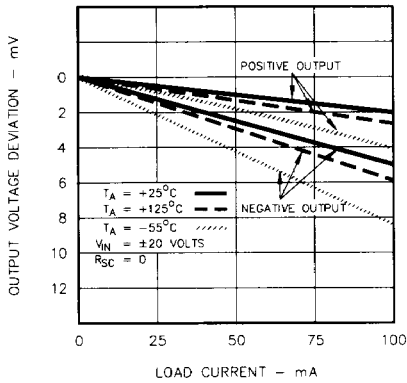

FIGURE 1. LOAD REGULATION

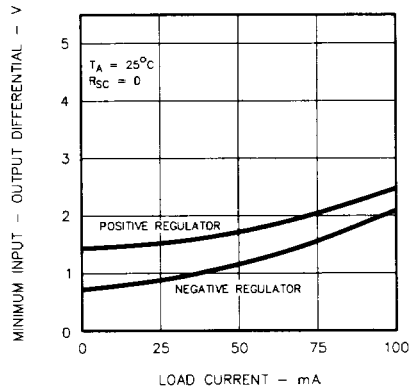

FIGURE 2. REGULATOR DROPOUT VOLTAGE

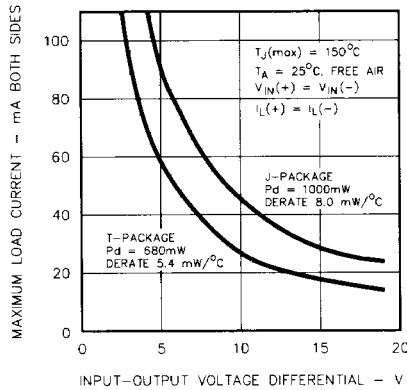

FIGURE 3. MAXIMUM CURRENT CAPABILITY

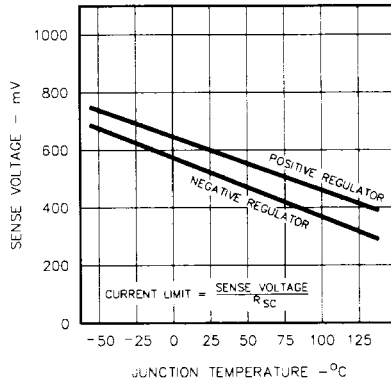

FIGURE 4. CURRENT LIMITING CHARACTERISTICS

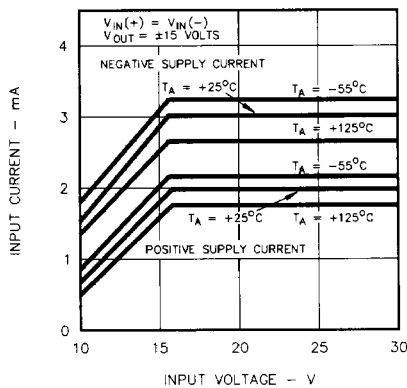

FIGURE 5. STANDBY CURRENT DRAIN

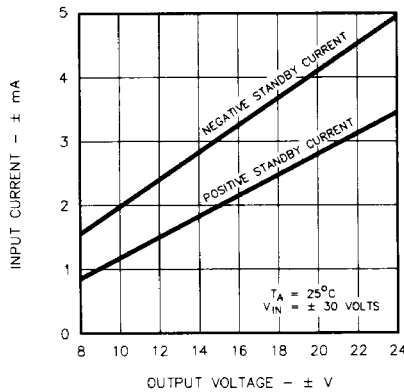
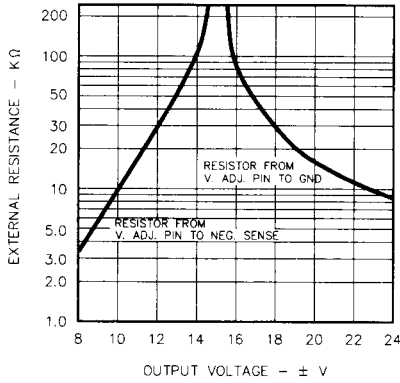
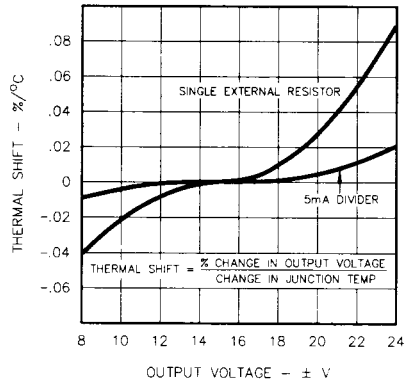

FIGURE 6. STANDBY CURRENT DRAIN

**CHARACTERISTIC CURVES**



**FIGURE 7.**  
EXTERNAL PARALLEL RESISTOR REQUIRED FOR VOLTAGES OTHER THAN  $\pm 15$  VOLTS



**FIGURE 8.**  
TEMPERATURE COEFFICIENT OF OUTPUT VOLTAGE

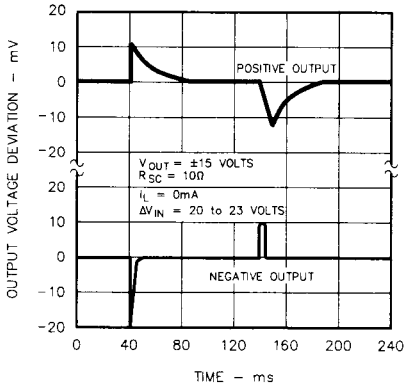

**FIGURE 9.**  
LINE TRANSIENT RESPONSE

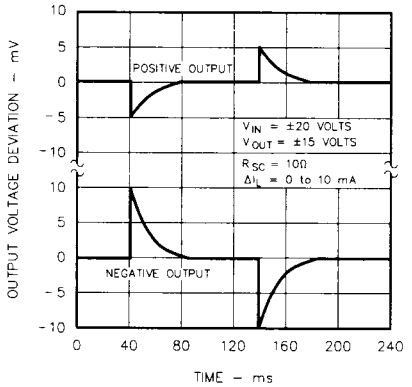

**FIGURE 10.**  
LOAD TRANSIENT RESPONSE

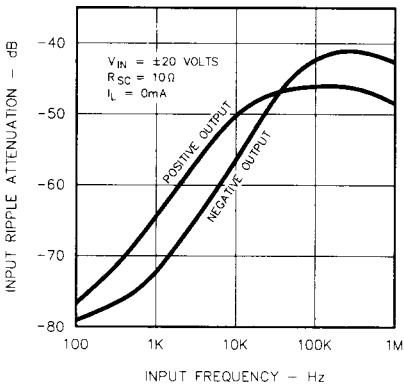

**FIGURE 11.**  
RIPPLE REJECTION

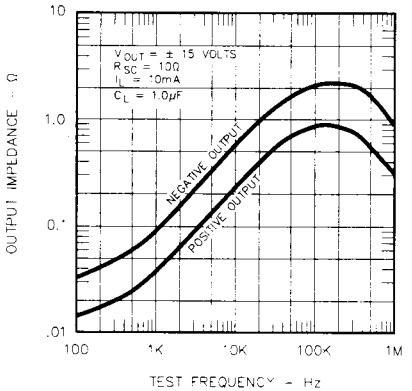

**FIGURE 12.**  
OUTPUT IMPEDANCE

## TYPICAL APPLICATIONS

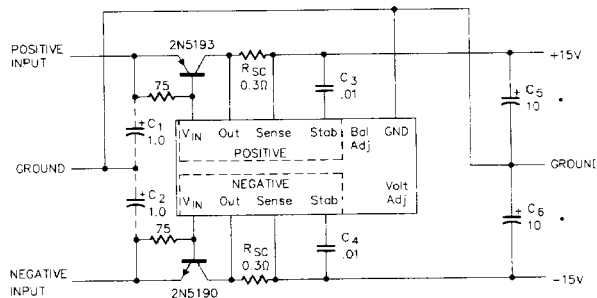
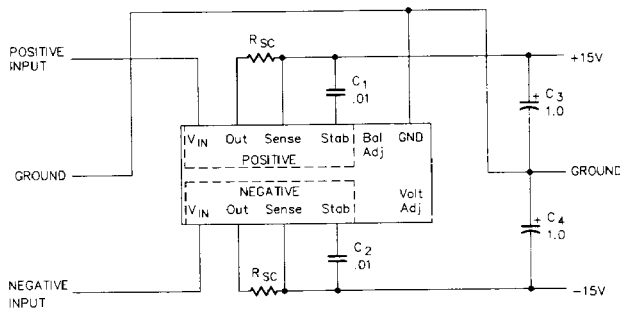

FIGURE 13 - HIGH CURRENT CONFIGURATION, ONE AMP OUTPUT

For full power output, the external transistors must be mounted on adequate heat sinks. Selection of power transistors may be made on the basis of current and voltage capability with low-frequency devices preferred to minimize the risk of oscillation. In this circuit, the value of  $R_{SC}$  is selected in order to protect the pass transistors rather than the IC.  $C_1$  and  $C_2$  are only necessary if high line impedance is present.

FIGURE 14 - BASIC  $\pm 15$  V, 50mA REGULATOR

Additional reduction in output noise voltage may be achieved with larger values for  $C_1$  and  $C_2$  although there is some loss in frequency response.  $C_3$  and  $C_4$  may also be increased to improve load transient characteristics. Note that the case is common to  $-V_{IN}$ , not ground.

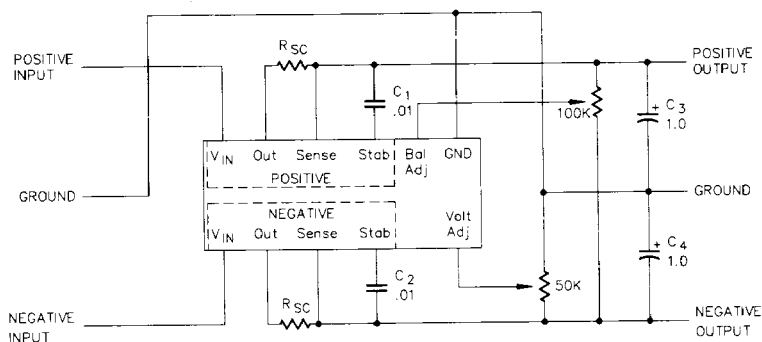

FIGURE 15 - ADJUSTMENT OF VOLTAGE LEVELS

Greater resolution may be achieved by padding each of the potentiometer with fixed resistors. Also, a single resistor, rather than a divider, may be used when adjustment in only one direction is required, but some degradation in temperature coefficient results (see temperature coefficient of output voltage curve).

**APPLICATION NOTE**

Although the SG1501A series contains thermal limiting circuitry, the maximum current must still be controlled to allow time for this protection to react. Therefore, without external pass transistors, the minimum value for  $R_{sc}$  is three ohms.  $R_{sc}$  can, of course, have a larger value in order to protect a load.

the negative side when the device goes into current limiting. Should this be a problem, it may be eliminated by by-passing  $R_{sc}$  with a capacitor whose value is such that the time constant,  $R_{sc} C$ , is equal to  $10 \times 10^{-6}$  second. This capacitor, as well as the output capacitors, C3 and C4, must be low ESR types such as solid tantalum.

Under some conditions, a low-level oscillation may be present on

**CONNECTION DIAGRAMS & ORDERING INFORMATION** (See Note Below)

Package	Part No.	Ambient Temperature Range	Connection Diagram
14-PIN CERAMIC DIP J - PACKAGE	SG1501AJ/883B SG1501AJ SG2501AJ SG3501AJ SG4501T	-55°C to 125°C -55°C to 125°C 0°C to 70°C 0°C to 70°C 0°C to 70°C	
14-PIN PLASTIC DIP N - PACKAGE	SG2501AN SG3501AN SG4501N	0°C to 70°C 0°C to 70°C 0°C to 70°C	
10-PIN TO-100 METAL CAN T-PACKAGE	SG1501AT/883B SG1501AT SG2501AT SG3501AT SG4501T	-55°C to 125°C -55°C to 125°C 0°C to 70°C 0°C to 70°C 0°C to 70°C	
20-PIN CERAMIC LEADLESS CHIP CARRIER L - PACKAGE	SG1501AL/883B SG1501AL	-55°C to 125°C -55°C to 125°C	<p>(Note 3)</p>

Note 1. All packages are viewed from the top.  
 Note 2. The Balance Adjust function is not available in the "T" package.  
 Note 3. The Negative Input (V-) pin is internally connected to the case.