

POWER TVS COMPONENT

APPLICATIONS

- ✓ Relay Drives
- ✓ Motor (Start/Stop) Back EMF Protection
- ✓ Module Lightning Protection

IEC COMPATIBILITY (EN61000-4)

- ✓ 61000-4-5 (Surge): 48A, 8/20 μ s - L3 (Line-Gnd), L4 (Line-Line) & L1 (Power)

FEATURES

- ✓ 30,000 Watts Peak Pulse Power per Line ($t_p=10/1000\mu$ s)
- ✓ Unidirectional & Bidirectional Configurations
- ✓ Easy Mounting to Printed Circuit Board
- ✓ Available in Multiple Voltage Types Ranging From: 30V to 280V

MECHANICAL CHARACTERISTICS

- ✓ Molded Case
- ✓ Weight 5 grams (Approximate)
- ✓ Flammability rating UL 94V-0
- ✓ Marking: Logo, Part Number & Date Code
- ✓ Positive Terminal Marked with Band - *Unidirectional Only*

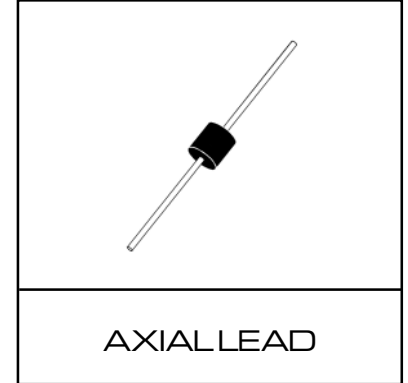

APPLICATION

TYPICAL RELAY DRIVE PROTECTION

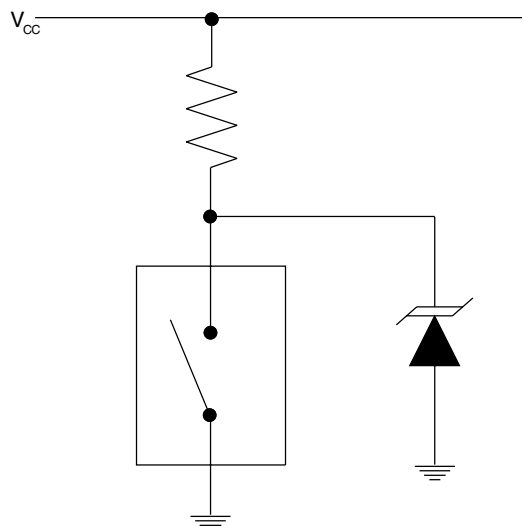

DEVICE CHARACTERISTICS

MAXIMUM RATINGS @ 25°C Unless Otherwise Specified			
PARAMETER	SYMBOL	VALUE	UNITS
Peak Pulse Power (tp =10/1000µs) - See Fig. 1	P _{PP}	30,000	Watts
Forward Surge Rating (1/20 seconds) - See Note 2	I _F	200	Amps
Steady State Power Dissipation	P _D	1.0	Watts
Storage Temperature	T _{STG}	-55 to +150	°C
Operating Temperature	T _J	-55 to +150	°C

ELECTRICAL CHARACTERISTICS						
PART NUMBER (Notes 1 & 2)	RATED STAND-OFF VOLTAGE V _{WM} VOLTS	BREAKDOWN VOLTAGE		MAXIMUM LEAKAGE CURRENT @ V _{WM} I _D µA	MAXIMUM CLAMPING VOLTAGE (See Fig. 2) @ 10/1000µs V _C @ I _{PP}	TEMPERATURE COEFFICIENT OF V _(BR) θV _(BR) mV/°C
		MIN V _(BR) VOLTS	@ I _T mA			
30KPA30A	30.0	33.3	50	5000	55.2V @ 543.0A	34
30KPA36A	36.0	40.0	50	2000	61.8V @ 485.0A	41
30KPA43A	43.0	47.8	50	1000	73.0V @ 410.0A	50
30KPA48A	48.0	53.3	5	250	77.4V @ 388.0A	56
30KPA58A	58.0	64.4	5	20	92.4V @ 325.0A	68
30KPA64A	64.0	71.1	5	10	104.0V @ 294.0A	76
30KPA70A	70.0	77.8	5	10	109.0V @ 274.0A	83
30KPA75A	75.0	83.3	5	10	119.4V @ 251.0A	89
30KPA90A	90.0	100.0	5	10	147.0V @ 206.0A	109
30KPA160A	160.0	178.0	5	10	252.6V @ 119.0A	195
30KPA180A	180.0	200.0	5	10	291.0V @ 104.0A	230
30KPA220A	220.0	245.0	5	10	356.0V @ 84.0A	269
30KPA260A	260.0	289.0	5	10	416.0V @ 72.0A	317
30KPA280A	280.0	311.0	5	10	464.0V @ 65.0A	342

Note 1: Part numbers shown are unidirectional devices. Add a "CA" suffix to specify bidirectional devices, such as 30KPA30CA. Devices shown are preferred voltages. Contact factory for additional voltages.

Note 2: V_F = 15 Volts @ 200A, 8.3ms (1/2 Sine Wave) - unidirectional devices only.

GRAPHS

**FIGURE 1
 PEAK PULSE POWER VS PULSE TIME**

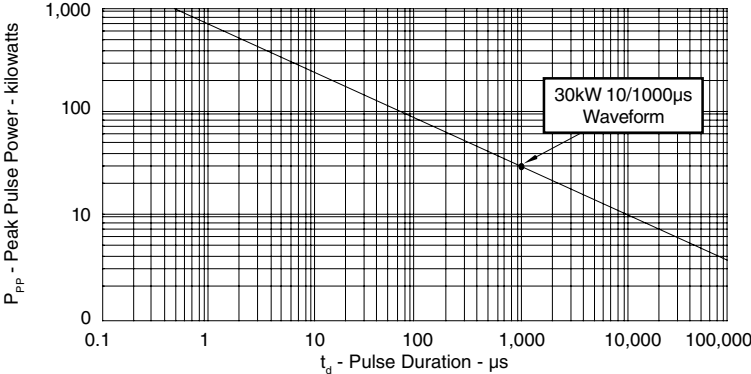

**FIGURE 2
 PULSE WAVE FORM**

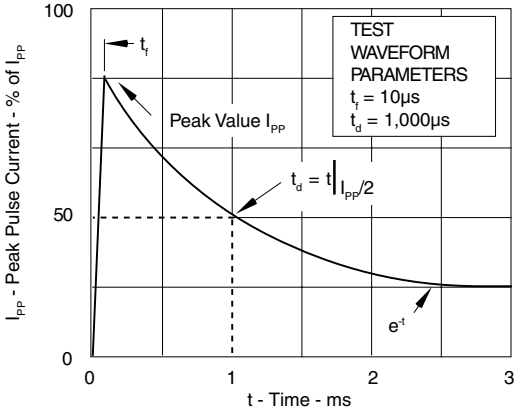

**FIGURE 3
 POWER DERATING CURVE**

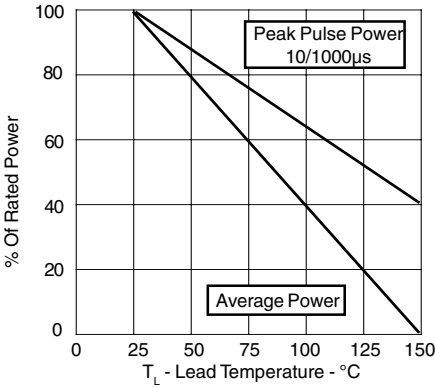

30KPA30A thru 30KPA280A

PACKAGE OUTLINE & DIMENSIONS

PACKAGE OUTLINE

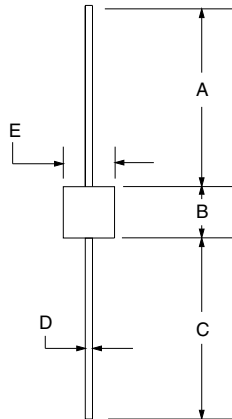

30KPA

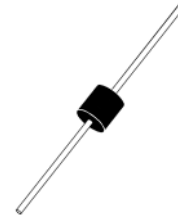

PACKAGE DIMENSIONS

DIM	MILLIMETERS		INCHES	
	MIN	MAX	MIN	MAX
A	24.5	-	1.00	-
B	8.60	9.10	0.34	0.36
C	24.5	-	1.00	-
D	1.20 DIA	1.30 DIA	0.048 DIA	0.052 DIA
E	8.60	9.10	0.34	0.36

NOTES:

1. Dimensions are exclusive of mold flash and metal burrs.

Outline & Dimensions: Rev 0 - 12/01, 06028

COPYRIGHT © ProTek Devices 2005

SPECIFICATIONS: ProTek reserves the right to change the electrical and or mechanical characteristics described herein without notice (except JEDEC).

DESIGN CHANGES: ProTek reserves the right to discontinue product lines without notice, and that the final judgement concerning selection and specifications is the buyer's and that in furnishing engineering and technical assistance, ProTek assumes no responsibility with respect to the selection or specifications of such products.

ProTek Devices

2929 South Fair Lane, Tempe, AZ 85282

Tel: 602-431-8101 Fax: 602-431-2288

E-Mail: sales@protekdevices.com

Web Site: www.protekdevices.com