

Optocoupler, Phototransistor Output, Low Input Current, Low Input Current, with Base Connection

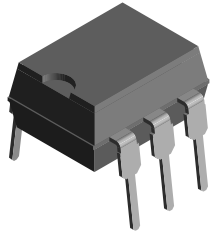

1179004

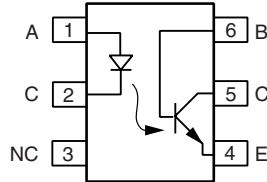

FEATURES

- Guaranteed at $I_F = 1.0 \text{ mA}$
- High collector emitter voltage, $BV_{CEO} = 70 \text{ V}$
- Long term stability
- Industry standard DIP package
- Lead (Pb)-free component
- Component in accordance to RoHS 2002/95/EC and WEEE 2002/96/EC



RoHS
COMPLIANT

AGENCY APPROVALS

- UL1577, file no. E52744 system code H or J, double protection
- DIN EN 60747-5-5 available with option 1
- BSI IEC 60950; IEC 60065

DESCRIPTION

The IL201/IL202/IL203 are optically coupled pairs employing a gallium arsenide infrared LED and a silicon NPN phototransistor. Signal information, including a DC level, can be transmitted by the device while maintaining a high degree of electrical isolation between input and output. The IL201/IL202/IL203 can be used to replace relays and transformers in many digital interface applications, as well as analog applications such as CRT modulation.

ORDER INFORMATION	
PART	REMARKS
IL201	CTR 75 to 150 %, DIP-6
IL202	CTR 125 to 250 %, DIP-6
IL203	CTR 225 to 450 %, DIP-6
IL203-X007	CTR 225 to 450 %, SMD-6 (option 7)
IL203-X009	CTR 225 to 450 %, SMD-6 (option 9)

Note

For additional information on the available options refer to option information.

ABSOLUTE MAXIMUM RATINGS				
PARAMETER	TEST CONDITION	SYMBOL	VALUE	UNIT
INPUT				
Peak reverse voltage		V_R	6.0	V
Forward continuous current		I_F	60	mA
Power dissipation		P_{diss}	100	mW
Derate linearly from 25 °C			1.33	mW/°C
OUTPUT				
Collector emitter breakdown voltage		BV_{CEO}	70	V
Emitter collector breakdown voltage		BV_{ECO}	7.0	V
Collector base breakdown voltage		BV_{CBO}	70	V
Power dissipation		P_{diss}	200	mW
Derate linearly from 25 °C			2.6	mW/°C



Optocoupler, Phototransistor Output, Vishay Semiconductors
Low Input Current, Low Input Current,
with Base Connection

ABSOLUTE MAXIMUM RATINGS				
PARAMETER	TEST CONDITION	SYMBOL	VALUE	UNIT
COUPLER				
Isolation test voltage	t = 1.0 s	V _{ISO}	5300	V _{RMS}
Total package dissipation (LED and detector)		P _{tot}	250	mW
Derate linearly from 25 °C			3.3	mW/°C
Creepage distance			≥ 7.0	mm
Clearance distance			≥ 7.0	mm
Storage temperature		T _{stg}	- 55 to + 150	°C
Operating temperature		T _{amb}	- 55 to + 100	°C
Lead soldering time	≤ 260 °C		10	s

Note

T_{amb} = 25 °C, unless otherwise specified.

Stresses in excess of the absolute maximum ratings can cause permanent damage to the device. Functional operation of the device is not implied at these or any other conditions in excess of those given in the operational sections of this document. Exposure to absolute maximum ratings for extended periods of the time can adversely affect reliability.

ELECTRICAL CHARACTERISTICS						
PARAMETER	TEST CONDITION	SYMBOL	MIN.	TYP.	MAX.	UNIT
INPUT						
Forward voltage	I _F = 20 mA	V _F		1.2	1.5	V
	I _F = 1.0 mA	V _F		1.0	1.2	V
Breakdown voltage	I _R = 10 µA	V _F	6.0	20		V
Reverse current	V _R = 6.0 V	I _R		0.1	10	µA
OUTPUT						
DC forward current gain	V _{CE} = 5.0 V, I _C = 100 µA	h _{FE}	100	200		
Collector emitter breakdown voltage	I _C = 100 µA	BV _{CEO}	70			V
Emitter collector breakdown voltage	I _E = 100 µA	BV _{ECO}	7.0	10		V
Collector base breakdown voltage	I _C = 10 µA	BV _{CBO}	70	90		V
Leakage current collector emitter	V _{CE} = 10 V, T _A = 25 °C	I _{CEO}		5.0	50	nA

Note

T_{amb} = 25 °C, unless otherwise specified.

Minimum and maximum values are testing requirements. Typical values are characteristics of the device and are the result of engineering evaluation. Typical values are for information only and are not part of the testing requirements.

CURRENT TRANSFER RATIO							
PARAMETER	TEST CONDITION	PART	SYMBOL	MIN.	TYP.	MAX.	UNIT
Current transfer ratio (collector to base)	I _F = 10 mA, V _{CB} = 10 V		CTR _{CB}	15			%
	I _F = 10 mA, I _C = 2.0 mA		CTR _{CB}			40	%
DC current transfer ratio	I _F = 10 mA, V _{CB} = 10 V	IL201	CTR _{DC}	75	100	150	%
		IL202	CTR _{DC}	125	200	250	%
		IL203	CTR _{DC}	225	300	450	%
	I _F = 1.0 mA, V _{CE} = 10 V	IL201	CTR _{DC}	10			%
		IL202	CTR _{DC}	30			%
		IL203	CTR _{DC}	50			%

Vishay Semiconductors Optocoupler, Phototransistor Output,
Low Input Current, Low Input Current,
with Base Connection

TYPICAL CHARACTERISTICS

$T_{amb} = 25\text{ }^{\circ}\text{C}$, unless otherwise specified

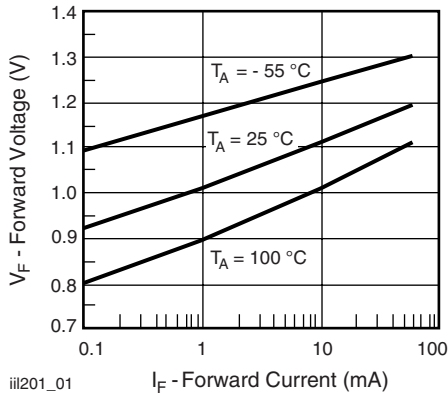

Fig. 1 - Forward Voltage vs. Forward Current

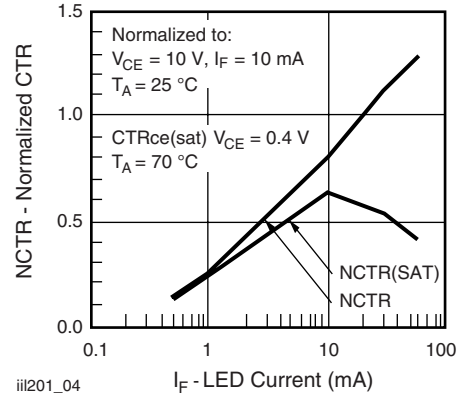

Fig. 4 - Normalized Non-Saturated and Saturated CTR vs. LED Current

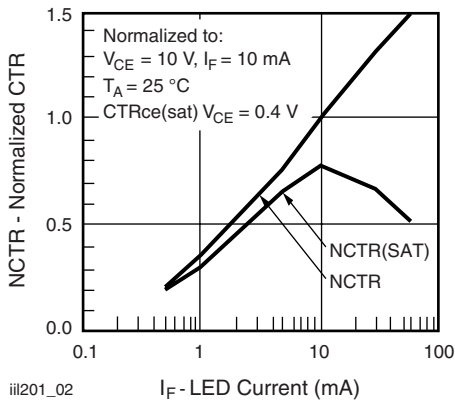

Fig. 2 - Normalized Non-Saturated and Saturated CTR vs. LED Current

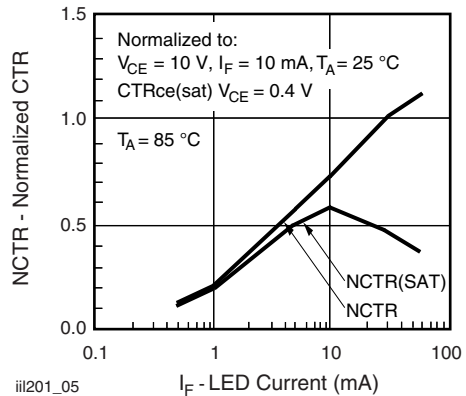

Fig. 5 - Normalized Non-Saturated and Saturated CTR vs. LED Current

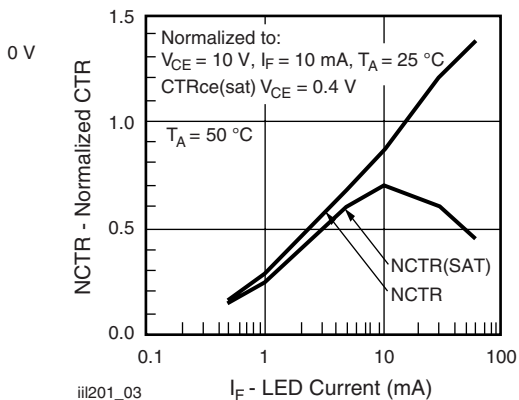

Fig. 3 - Normalized Non-Saturated and Saturated CTR vs. LED Current

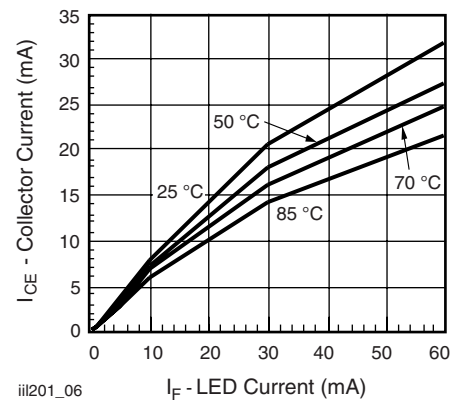

Fig. 6 - Collector Emitter Current vs. Temperature and LED Current

Optocoupler, Phototransistor Output, Vishay Semiconductors
 Low Input Current, Low Input Current,
 with Base Connection

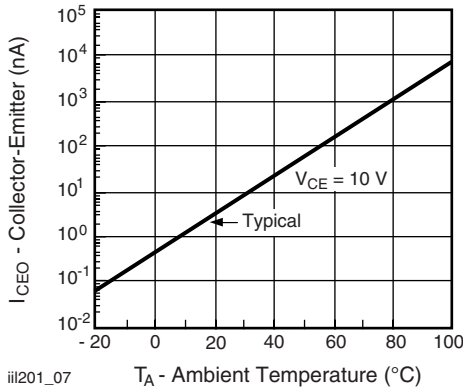

Fig. 7 - Collector Emitter Leakage Current vs. Temperature

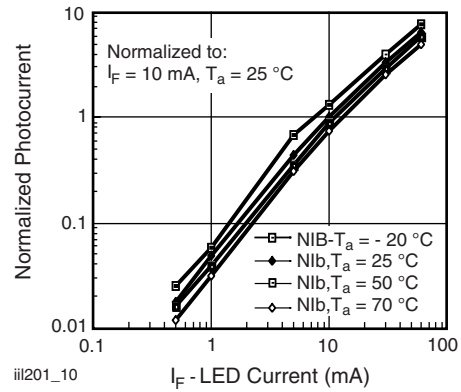

Fig. 10 - Normalized Photocurrent vs. I_F and Temperature

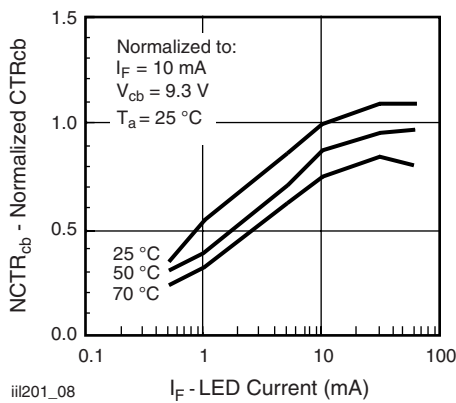

Fig. 8 - Normalized CTR_{cb} vs. LED Current and Temperature

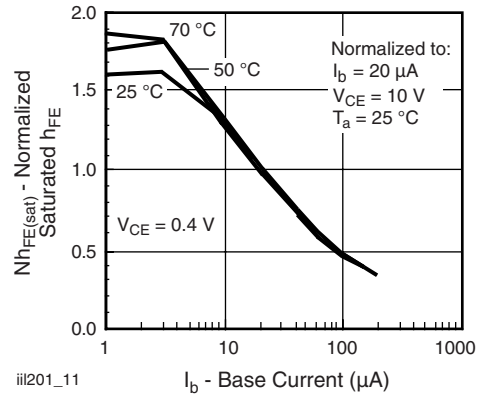

Fig. 11 - Normalized Saturated h_{FE} vs. Base Current and Temperature

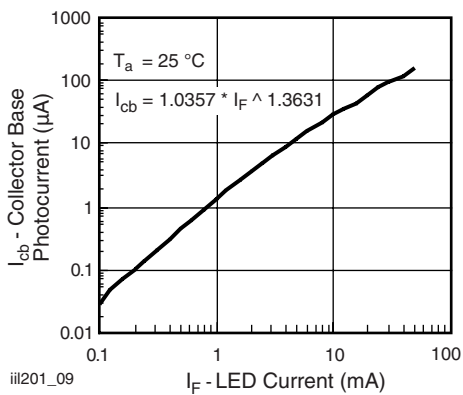

Fig. 9 - Collector Base Photocurrent vs. LED Current

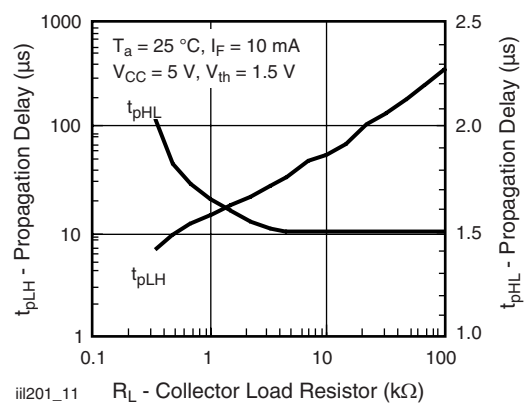

Fig. 12 - Propagation Delay vs. Collector Load Resistor

Vishay Semiconductors Optocoupler, Phototransistor Output,
Low Input Current, Low Input Current,
with Base Connection

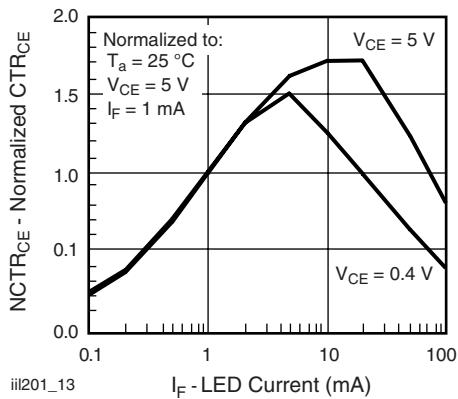

Fig. 13 - Normalized Non-Saturated and Saturated CTR_{CE} vs. LED Current

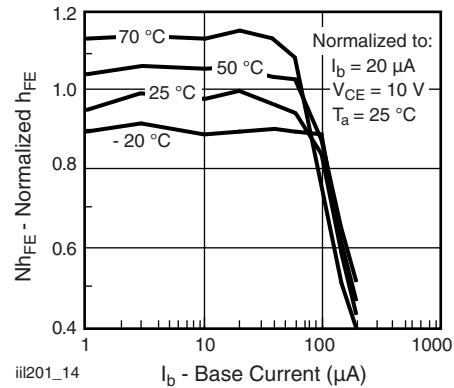
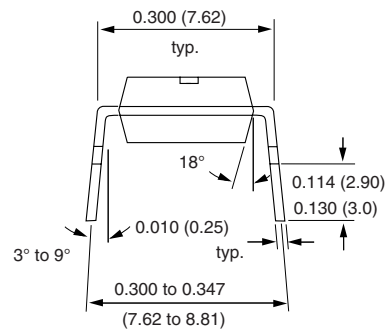
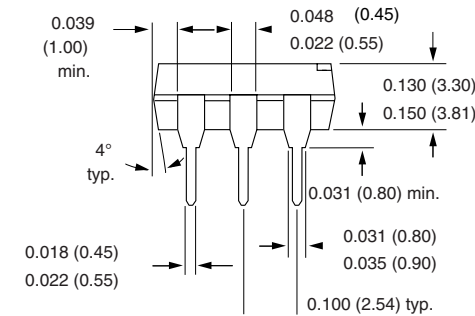
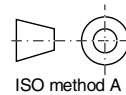
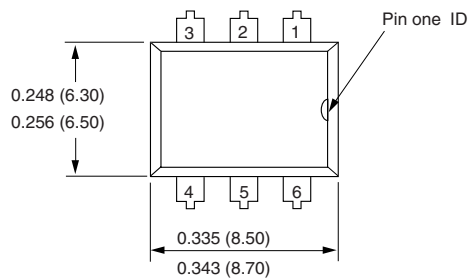

Fig. 14 - Normalized Non-Saturated h_{FE} vs. Base Current and Temperature

PACKAGE DIMENSIONS in inches (millimeters)



i178004

Option 7

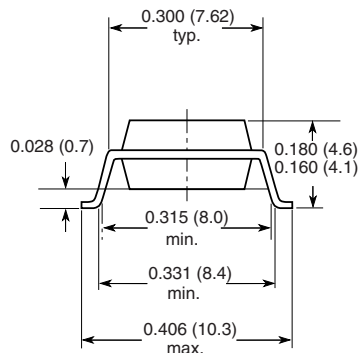

Option 9

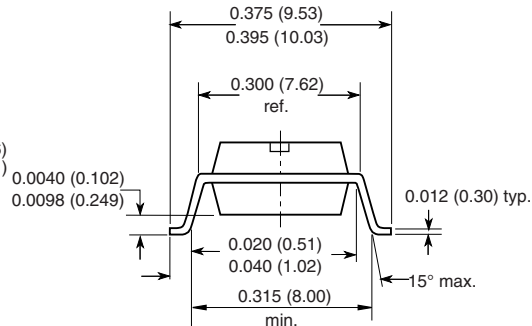

18494



Optocoupler, Phototransistor Output, Vishay Semiconductors
Low Input Current, Low Input Current,
with Base Connection

OZONE DEPLETING SUBSTANCES POLICY STATEMENT

It is the policy of Vishay Semiconductor GmbH to

1. Meet all present and future national and international statutory requirements.
2. Regularly and continuously improve the performance of our products, processes, distribution and operating systems with respect to their impact on the health and safety of our employees and the public, as well as their impact on the environment.

It is particular concern to control or eliminate releases of those substances into the atmosphere which are known as ozone depleting substances (ODSs).

The Montreal Protocol (1987) and its London Amendments (1990) intend to severely restrict the use of ODSs and forbid their use within the next ten years. Various national and international initiatives are pressing for an earlier ban on these substances.

Vishay Semiconductor GmbH has been able to use its policy of continuous improvements to eliminate the use of ODSs listed in the following documents.

1. Annex A, B and list of transitional substances of the Montreal Protocol and the London Amendments respectively.
2. Class I and II ozone depleting substances in the Clean Air Act Amendments of 1990 by the Environmental Protection Agency (EPA) in the USA.
3. Council Decision 88/540/EEC and 91/690/EEC Annex A, B and C (transitional substances) respectively.

Vishay Semiconductor GmbH can certify that our semiconductors are not manufactured with ozone depleting substances and do not contain such substances.

We reserve the right to make changes to improve technical design
and may do so without further notice.

Parameters can vary in different applications. All operating parameters must be validated for each customer application by the customer. Should the buyer use Vishay Semiconductors products for any unintended or unauthorized application, the buyer shall indemnify Vishay Semiconductors against all claims, costs, damages, and expenses, arising out of, directly or indirectly, any claim of personal damage, injury or death associated with such unintended or unauthorized use.

Vishay Semiconductor GmbH, P.O.B. 3535, D-74025 Heilbronn, Germany



Disclaimer

All product specifications and data are subject to change without notice.

Vishay Intertechnology, Inc., its affiliates, agents, and employees, and all persons acting on its or their behalf (collectively, "Vishay"), disclaim any and all liability for any errors, inaccuracies or incompleteness contained herein or in any other disclosure relating to any product.

Vishay disclaims any and all liability arising out of the use or application of any product described herein or of any information provided herein to the maximum extent permitted by law. The product specifications do not expand or otherwise modify Vishay's terms and conditions of purchase, including but not limited to the warranty expressed therein, which apply to these products.

No license, express or implied, by estoppel or otherwise, to any intellectual property rights is granted by this document or by any conduct of Vishay.

The products shown herein are not designed for use in medical, life-saving, or life-sustaining applications unless otherwise expressly indicated. Customers using or selling Vishay products not expressly indicated for use in such applications do so entirely at their own risk and agree to fully indemnify Vishay for any damages arising or resulting from such use or sale. Please contact authorized Vishay personnel to obtain written terms and conditions regarding products designed for such applications.

Product names and markings noted herein may be trademarks of their respective owners.