



UNIVERSAL JOINTS

2

basic principles

Universal joints (U/J's) transmit rotation from one shaft placed end to end with another. They will operate at a much larger angle than is permissible with a misalignment coupler and are commonly used in pairs to take a drive train through laterally displaced axes. The ability to change angle while operating under load gives U/J's a further advantage and in these applications, a telescopic drive shaft is used to accommodate accompanying changes in length.

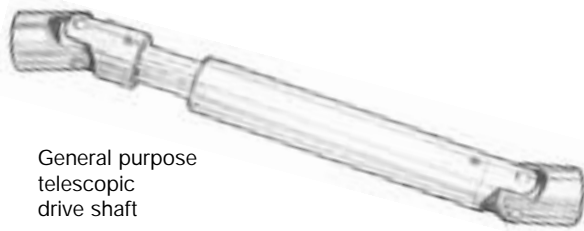

General purpose telescopic drive shaft

Although constructional details can differ widely between one maker's product and the next, U/J's fall into two groups identified as constant velocity or non-constant velocity joints. Constant velocity types are most often seen on front wheel drive vehicles. They are relatively costly to produce and are generally purpose designed for the application. The joints featured in this catalogue work on the Hookes or Cardan principle and are of the non-constant velocity type.

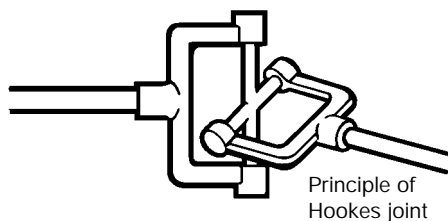

Principle of Hookes joint

What this means is that for a given operating angle the output velocity fluctuates even though the input velocity is constant. These fluctuations result in the output gaining, then lagging with respect to the input, twice in each revolution to an extent governed by the operating angle. The fluctuation is predictable and varies between

$$\omega \cos \alpha$$

$$\text{and } \omega \sec \alpha$$

where ω = angular velocity (speed rev/min)
and α = operating angle

Thus at an operating angle of 5°, the fluctuation is ±0.4%, at 7° ±0.8% and at 10° ±1.5%. For example, a motor shaft turning at a constant 1000 rpm, driving through a single universal joint set at an operating angle of 5°, will produce an output that fluctuates between 996 and 1004 rpm twice every revolution. At low speed or on manual operation, the fluctuations will be of interest only in calibrated applications; at higher speeds, they will increasingly give rise to torsional vibration.

Constant velocity output can be restored by using a double joint or by connecting two single joints back to back. Two rules must be observed:

1. The operating angle must be the same at the input end as at the output end (Figs. 1 & 2).
2. When connecting two single joints, they must be orientated so that the inboard lugs are in line (Fig. 3).

Under these conditions the fluctuations in the first joint will for all practical purposes be cancelled out by the complementary fluctuations in the second.

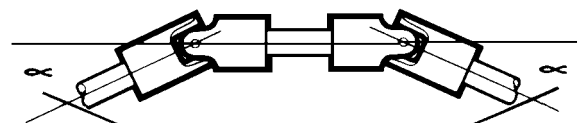

Fig 1

These angles must be equal

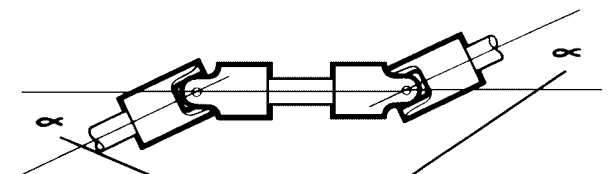

Fig 2

These angles must be equal

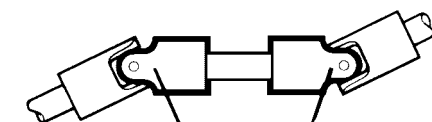

Fig 3

Inboard lugs in line

UNIVERSAL JOINTS

application

Universal joints are typically used to transmit positive rotation through intentional offsets where the power source is some way from the load. It is important to note that a U/J is essentially a pivot and that it cannot accommodate any parallel displacement between shafts if used singly. Moreover, the installation must allow for some adjustment when mounting the joint so that the shaft centre lines can be made to converge at the fulcrum of the joint. This is essential if the joint is to function correctly and not impose excessive radial loads on adjacent bearings.

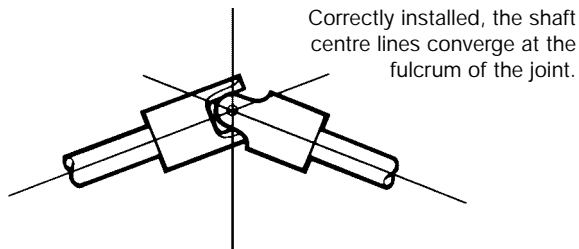

Most applications however, demand a pair of U/J's. This yields several advantages including constant velocity output, a less critical installation procedure, a shared operating angle (each joint works at 50% of the total), and the ability to drive through laterally displaced shafts. A pair of joints can comprise a drive shaft with a U/J at each end or a double U/J for close coupled applications. A double U/J offers greater misalignment compensation than a misalignment coupler and runs at higher efficiency. For a given torque rating however, it is usually significantly longer.

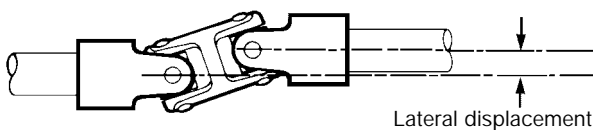
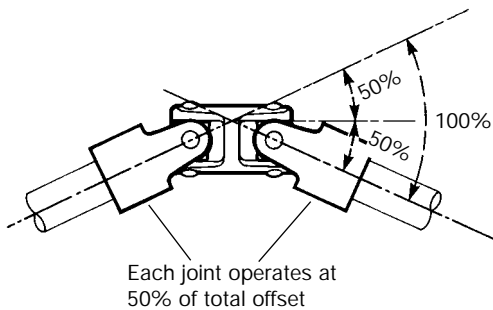

Telescopic drive shafts with a single U/J fitted at each end are used to power mechanisms that move in relation to the power source. The most common example is the drive shaft connecting the gearbox to the rear axle on a road vehicle. Another is the power take-off fitted at the rear of a tractor to power-up ancillaries towed behind it. There are many more applications in machine tools, packaging machinery and the like. As the driven mechanism moves, the distance between the U/J centres changes and since U/J's cannot accommodate end movement, a telescoping facility is built into the drive shafts. Typically, this takes the form of a splined shaft with matching broached tube. For lightly loaded or less critical applications, nesting tubes cut from square material are adequate for the purpose. It should be noted that although a pair of U/J's connected by a drive shaft and correctly set up will produce a constant velocity output, the connecting shaft turns in sympathy with the output of the first joint and is therefore subject to the fluctuations governed by the working angle of the first joint.

selection

U/J's are selected for size on the basis of the torque to be transmitted, the speed of rotation and the operating angle. These variables give rise to a performance chart on which the values can be read off and a suitable joint selected. Factors relating to the nature of the power source or load are sometimes applied. A single cylinder internal combustion engine for example is more punishing to the transmission than an electric motor. An even load is less onerous than an intermittent one.

In principle, a U/J works harder as the operating angle increases. The larger the operating angle, the lower the torque or the speed at which it can be transmitted, or both.

In selecting the best type of universal joint for a given application, the intended duty and life requirement are the determining factors. High speeds and/or operating angles are best handled by U/J's fitted with roller bearings. These are lubricated for life but it is nevertheless a good plan to protect the moving surfaces with a gaiter which prevents the ingress of dust, moisture and other foreign matter. Roller bearing joints are generally specified where sustained rotational speeds exceed 1200/1500 rpm.

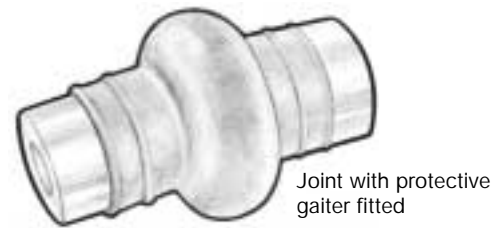

The most commonly specified joints are those fitted with plain bearings. These are better at withstanding shock loads and are adequate for speeds up to 1200/1500 rpm. Journals and bearings are usually heat treated then ground and honed respectively. On larger U/J's, the bearing may be manufactured separately and pressed into the parent metal before assembly. To ensure an adequate service life, U/J's should be regularly lubricated. Where this is difficult due to inaccessibility, gaiters will retain the lubricant and afford protection in aggressive environments. For low speed or manual operation only, an 'economy series' joint may be adequate. These are manufactured to looser tolerances and dispense with the hardening, grinding and honing of bearings.

Lastly, U/J's manufactured in plastics combined with non-ferrous metals offer economy plus a set of properties not found in steel joints. Foremost among these are their light weight, resistance to corrosion electrical non-conductivity and freedom from both lubrication and backlash. A supreme advantage of the moulding technique is the cost-saving opportunities it offers. Examples are the ease of producing non-circular bores and the ability to integrate related components in the moulding process, typically gear forms and toothed belt pulleys.

Compared with similarly sized steel joints, plastics U/J's have a significantly lower torque carrying capability.



Huco-Pol U/J's and telescopic drives are manufactured in acetal and non-ferrous metals for cost-effective use in light duty applications. Bored Ø3mm to 16mm, the joints feature backlash-free articulation.

Catalogue available on request.

STEEL UNIVERSAL JOINTS

features

Huco universal joints feature a comprehensive range of sizes manufactured in good quality steels. Plain bearing and needle roller types are available and either can be supplied with square, hexagonal or keywayed bores to order. The joints are also manufactured with quick release collars and in telescopic form to order.

types TL & TS, plain bearings – 1200 rpm max

These joints feature hardened journals of generous proportions. In joint sizes 13 – 60 (external diameter in mm) they are retained in the forks and pivot in holes provided in the central core. A large bearing surface is thus achieved which helps to reduce wear and tear and prolongs the operational life of the joint.



By virtue of the increased wall thickness available in the larger joints, pins fitted to sizes 70 – 100 are retained in the central core and pivot in treated bushes housed in the fork ends.

type TR, needle roller bearings – 6000 rpm max

This series is intended for applications demanding high rotational speeds (up to 6000 rpm) and large working angles where operation is without benefit of periodic lubrication.





They are constructed with hardened and ground journals pivoting between caged needle roller bearings housed in the fork ends. Four bronze thrust rings interface between the central core and the inner surfaces of the forks. These help to achieve greater load capacities by minimising friction generated by side loads.

Although the joints are pre-lubricated, rubber gaiters are recommended as a protective measure in abrasive or damp environments and to prevent ingress of foreign matter. Note that good heat dissipation becomes important under conditions of high working angles and high rotational speeds.

Type TR joints are suitable for all high speed applications or where periodic lubrication is difficult, typically machine tools, textile machines, multi-spindle drilling and tapping machines, packaging machines, special purpose machines and mechanical applications generally.

styles & sizes

U/J's are produced in 17 sizes, identified by their outside diameter in mm. All sizes are available in single and double form.

| Style | Outline | Sizes |
|---|---|--------------------------------------|
| Extended unbored series with plain bearings |  | 13 to 60 with 10 intermediate sizes |
| Standard bored series with plain bearings |  | 13 to 100 with 15 intermediate sizes |
| Standard bored series with needle roller bearings |  | 20 to 50 with 3 intermediate sizes |

Any of these can be manufactured as a telescopic drive shaft. The range of practical bore diameters corresponding with universal joints is 5.00 – 60.00 mm.

STEEL UNIVERSAL JOINTS

type HS, plain bearings – 1500 rpm max



This series conforms to DIN 808 (alternative to DIN 7551) and features conventional construction comprising 1 long and 2 short journals with mutual location within the hardened centre block. Large bearings of equal diameter are machined into the fork ends which are subsequently induction hardened and honed to render a precision fit. A grinding operation on the inner faces of the forks corrects any distortion to ensure concentricity of bores.

The joints are suitable for all mechanical engineering applications where the maximum speed of rotation does not exceed 1500 rpm.

type HE

An economy series, similar to type HS but manufactured to a lesser specification which omits the grinding, honing and heat treatment operations. In consequence type HE is suitable only for low speed transmissions and is intended for manual operation or intermittent motorised applications.



lubrication

Regular lubrication at intervals consistent with the duty cycle is recommended in the interests of extending the life of the joint.

The joints should be adequately lubricated and the use of rubber gaiters loaded with grease is recommended. They protect against dust, damp and foreign matter and by ensuring permanent lubrication of the sliding surfaces, maintain optimum efficiency over a longer service life.

The gaiters are moulded in a special mix of synthetic rubber which permits their use in temperatures from -20°C to 100°C . They are resistant to oils, greases, many chemical agents, sea water and tropical climates.

The joints are suitable for use in machine tools, textile machines, agricultural equipment, multi-spindle drilling and tapping machines and mechanical engineering applications generally where the maximum speed of rotation does not exceed 1200 rpm.

also available

The range also includes:

- Joints with quick-release collars
- Joints with needle roller bearings
- Ball joints

Any of these executions can be supplied as telescopic drive shafts. Please contact Technical Sales for further information.

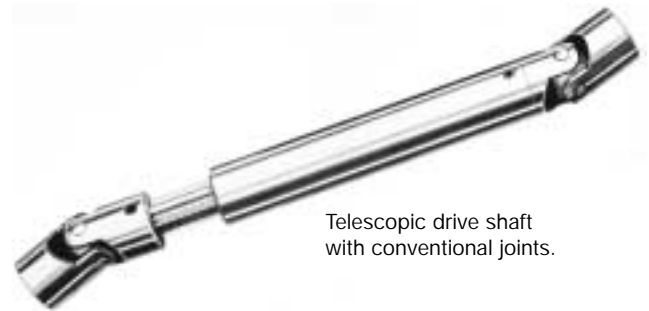

Telescopic drive shaft with conventional joints.



Telescopic drive shaft with ball joints.



Single ball joint.



Single joint fitted with needle roller bearings. The journals are machined integral with the central block.

STEEL UNIVERSAL JOINTS (T SERIES)

2

extended unbored joints with plain bearings

A series of good commercial quality joints manufactured to longer dimensions. They are stocked with solid ends for boring by the user.

Maximum working angle is 40° for single and 80° for double joint sizes 13 – 45. This reduces to 30° and 60° respectively for size 50 and upwards.

Maximum speed 1200 rpm, see performance charts on page 15.

These plain bearing universal joints must be lubricated. The use of gaiters is recommended.



type TL single joint

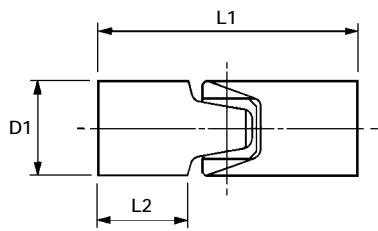

type TL double joint

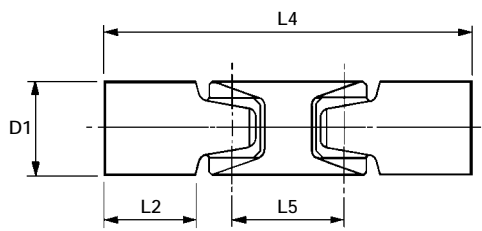

type T gaiter

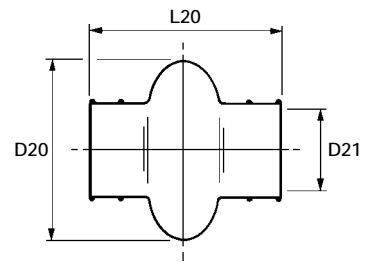

| Order Code | Bores | D1 | L1 | L2 | Static Torque at Break (Nm) |
|-------------|-------|----|-----|----|-----------------------------|
| 135.13.0000 | SOLID | 13 | 50 | 19 | 65 |
| 135.17.0000 | SOLID | 17 | 58 | 21 | 120 |
| 135.20.0000 | SOLID | 20 | 64 | 22 | 150 |
| 135.23.0000 | SOLID | 23 | 76 | 27 | 210 |
| 135.26.0000 | SOLID | 26 | 86 | 31 | 290 |
| 135.29.0000 | SOLID | 29 | 90 | 30 | 480 |
| 135.32.0000 | SOLID | 32 | 95 | 31 | 850 |
| 135.40.0000 | SOLID | 40 | 108 | 34 | 1350 |
| 135.45.0000 | SOLID | 45 | 127 | 44 | 1750 |
| 135.50.0000 | SOLID | 50 | 140 | 49 | 2500 |
| 135.55.0000 | SOLID | 55 | 165 | 57 | 4000 |
| 135.60.0000 | SOLID | 60 | 178 | 59 | 5000 |

| Order Code | Bores | D1 | L2 | L4 | L5 | Static Torque at Break (Nm) |
|-------------|-------|----|----|-----|----|-----------------------------|
| 137.13.0000 | SOLID | 13 | 19 | 73 | 23 | 65 |
| 137.17.0000 | SOLID | 17 | 21 | 85 | 27 | 120 |
| 137.20.0000 | SOLID | 20 | 22 | 94 | 30 | 150 |
| 137.23.0000 | SOLID | 23 | 27 | 110 | 34 | 210 |
| 137.26.0000 | SOLID | 26 | 31 | 122 | 36 | 290 |
| 137.29.0000 | SOLID | 29 | 30 | 131 | 41 | 480 |
| 137.32.0000 | SOLID | 32 | 31 | 142 | 47 | 850 |
| 137.40.0000 | SOLID | 40 | 34 | 164 | 56 | 1350 |
| 137.45.0000 | SOLID | 45 | 44 | 195 | 68 | 1750 |
| 137.50.0000 | SOLID | 50 | 49 | 212 | 72 | 2500 |
| 137.55.0000 | SOLID | 55 | 57 | 244 | 79 | 4000 |
| 137.60.0000 | SOLID | 60 | 59 | 266 | 88 | 5000 |

| Order Code | D20 | D21 | L20 |
|------------|-----|------|-----|
| - | - | - | - |
| 143.17 | 32 | 16.5 | 40 |
| 143.20 | 39 | 20.5 | 47 |
| 143.20 | 39 | 20.5 | 47 |
| 143.26 | 47 | 24.5 | 52 |
| 143.29 | 51 | 27.5 | 58 |
| 143.32 | 56 | 30.5 | 67 |
| 143.40 | 75 | 40.0 | 84 |
| 143.45 | 83 | 45.0 | 97 |
| 143.50 | 93 | 50.0 | 110 |
| 143.50 | 93 | 50.0 | 110 |
| 143.60 | 100 | 56.0 | 122 |

type TS single joint - stainless steel

| Order Code | Bores | D1 | L1 | L2 |
|-------------|-------|----|-----|----|
| 158.13.0000 | SOLID | 13 | 34 | 11 |
| 158.17.0000 | SOLID | 17 | 40 | 12 |
| 158.20.0000 | SOLID | 20 | 45 | 13 |
| 158.23.0000 | SOLID | 23 | 50 | 14 |
| 158.26.0000 | SOLID | 26 | 56 | 16 |
| 158.29.0000 | SOLID | 29 | 65 | 18 |
| 158.32.0000 | SOLID | 32 | 72 | 20 |
| 158.35.0000 | SOLID | 35 | 82 | 24 |
| 158.40.0000 | SOLID | 40 | 95 | 28 |
| 158.45.0000 | SOLID | 45 | 108 | 35 |
| 158.50.0000 | SOLID | 50 | 122 | 40 |
| 158.55.0000 | SOLID | 55 | 140 | 45 |
| 158.60.0000 | SOLID | 60 | 160 | 50 |

Performance values quoted on page 15 do not apply to stainless steel versions. Please contact Huco for application assistance.

STEEL UNIVERSAL JOINTS (T SERIES)

standard bored joints with plain bearings

A comprehensive range of good quality steel universals available in a range of standard sizes from stock. Alternative bores, round, keywayed or square, etc. can be produced to order. Also available in stainless steel. Please call Technical Sales for assistance with non-standard requirements.

Maximum working angle is 40° for single and 80° for double joint sizes 13 – 45. This reduces to 30° and 60° respectively for size 50 and upwards.

Maximum speed 1200 rpm, see performance charts on page 15.

These plain bearing universal joints must be lubricated.

The use of gaiters is recommended.



type TS single joint

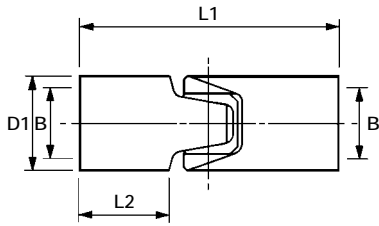

type TS double joint

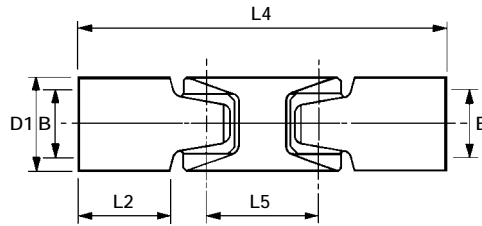

type T gaiter

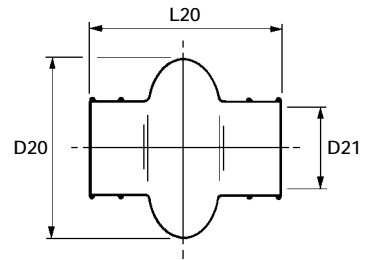

| Order Code | h7 Bores B | D1 | L1 | L2 | Static Torque at Break (Nm) |
|-------------|------------|-----|-----|----|-----------------------------|
| 134.13.2222 | 6 × 6 | 13 | 34 | 11 | 65 |
| 134.17.2828 | 8 × 8 | 17 | 40 | 12 | 120 |
| 134.20.3232 | 10 × 10 | 20 | 45 | 13 | 150 |
| 134.23.3535 | 12 × 12 | 23 | 50 | 14 | 210 |
| 134.26.3838 | 14 × 14 | 26 | 56 | 16 | 290 |
| 134.29.4242 | 16 × 16 | 29 | 65 | 18 | 480 |
| 134.32.4545 | 18 × 18 | 32 | 72 | 20 | 850 |
| 134.35.4848 | 20 × 20 | 35 | 82 | 24 | 1000 |
| 134.40.4949 | 22 × 22 | 40 | 95 | 28 | 1350 |
| 134.45.5252 | 25 × 25 | 45 | 108 | 35 | 1750 |
| 134.50.5656 | 30 × 30 | 50 | 122 | 40 | 2500 |
| 134.55.6060 | 35 × 35 | 55 | 140 | 45 | 4000 |
| 134.60.6363 | 40 × 40 | 60 | 160 | 50 | 5000 |
| 134.70.0000 | unbored | 70 | 175 | 50 | 8000 |
| 134.80.0000 | unbored | 80 | 190 | 55 | 11500 |
| 134.90.0000 | unbored | 90 | 210 | 65 | 13500 |
| 134.99.0000 | unbored | 100 | 230 | 70 | 16000 |

| Order Code | h7 Bores B | D1 | L2 | L4 | L5 | Static Torque at Break (Nm) |
|-------------|------------|-----|----|-----|-----|-----------------------------|
| 136.13.2222 | 6 × 6 | 13 | 11 | 57 | 23 | 65 |
| 136.17.2828 | 8 × 8 | 17 | 12 | 67 | 27 | 120 |
| 136.20.3232 | 10 × 10 | 20 | 13 | 75 | 30 | 150 |
| 136.23.3535 | 12 × 12 | 23 | 14 | 84 | 34 | 210 |
| 136.26.3838 | 14 × 14 | 26 | 16 | 92 | 36 | 290 |
| 136.29.4242 | 16 × 16 | 29 | 18 | 106 | 41 | 480 |
| 136.32.4545 | 18 × 18 | 32 | 20 | 119 | 47 | 850 |
| 136.35.4848 | 20 × 20 | 35 | 24 | 132 | 50 | 1000 |
| 136.40.4949 | 22 × 22 | 40 | 28 | 151 | 56 | 1350 |
| 136.45.5252 | 25 × 25 | 45 | 35 | 176 | 68 | 1750 |
| 136.50.5656 | 30 × 30 | 50 | 40 | 194 | 72 | 2500 |
| 136.55.6060 | 35 × 35 | 55 | 45 | 219 | 79 | 4000 |
| 136.60.6363 | 40 × 40 | 60 | 50 | 248 | 88 | 5000 |
| 136.70.0000 | unbored | 70 | 50 | 264 | 89 | 8000 |
| 136.80.0000 | unbored | 80 | 55 | 286 | 96 | 11500 |
| 136.90.0000 | unbored | 90 | 65 | 310 | 100 | 13500 |
| 136.99.0000 | unbored | 100 | 70 | 360 | 130 | 16000 |

| Order Code | D20 | D21 | L20 |
|------------|-----|------|-----|
| - | - | - | - |
| 143.17 | 32 | 16.5 | 40 |
| 143.20 | 39 | 20.5 | 47 |
| 143.20 | 39 | 20.5 | 47 |
| 143.26 | 47 | 24.5 | 52 |
| 143.29 | 51 | 27.5 | 58 |
| 143.32 | 56 | 30.5 | 67 |
| 143.35 | 66 | 35.5 | 74 |
| 143.40 | 75 | 40.0 | 84 |
| 143.45 | 83 | 45.0 | 97 |
| 143.50 | 93 | 50.0 | 110 |
| 143.50 | 93 | 50.0 | 110 |
| 143.60 | 100 | 56.0 | 122 |
| - | - | - | - |
| - | - | - | - |
| - | - | - | - |
| - | - | - | - |

STEEL UNIVERSAL JOINTS (T SERIES)

2

standard bored joints with needle roller bearings

A series of good commercial quality universals with needle roller bearings. The round bores listed are stock sizes, other diameters or solid ends can be supplied to order. Please call Technical Sales for alternative sizes including keywayed and square bores.

Maximum working angle is 40° for single and 80° for double joints.

Maximum speed 6000 rpm, see performance charts on page 15.

Bores listed under 'bores & order codes' are stock items. Other bores are supplied to order.



type TR single joint

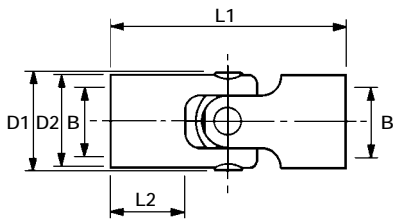

type TR double joint

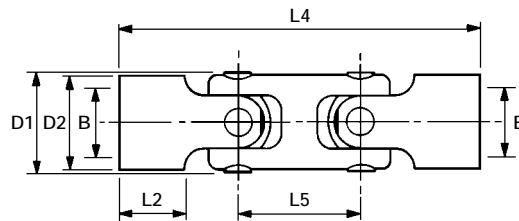

type T gaiter

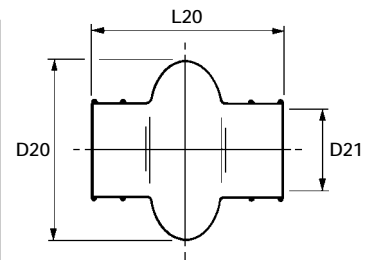

| Order Code | h7 Bores | B | D1 | L1 | L2 | Static Torque at Break (Nm) |
|-------------|----------|------|-----|----|------|-----------------------------|
| 138.20.3232 | 10 × 10 | 21.5 | 62 | 19 | 40 | 40 |
| 138.26.3838 | 14 × 14 | 27.9 | 74 | 23 | 130 | 130 |
| 138.32.4242 | 16 × 16 | 35.6 | 86 | 25 | 300 | 300 |
| 138.40.4848 | 20 × 20 | 42.7 | 108 | 33 | 500 | 500 |
| 138.50.5252 | 25 × 25 | 53.0 | 132 | 38 | 1200 | 1200 |

| Order Code | h7 Bores | B | D1 | D2 | L2 | L4 | L5 | Static Torque at Break (Nm) |
|-------------|----------|------|----|----|-----|----|------|-----------------------------|
| 139.20.3232 | 10 × 10 | 21.5 | 20 | 19 | 92 | 30 | 40 | 40 |
| 139.26.3838 | 14 × 14 | 27.9 | 26 | 23 | 110 | 36 | 130 | 130 |
| 139.32.4242 | 16 × 16 | 35.6 | 32 | 25 | 133 | 47 | 300 | 300 |
| 139.40.4848 | 20 × 20 | 42.7 | 40 | 33 | 164 | 56 | 500 | 500 |
| 139.50.5252 | 25 × 25 | 53.0 | 50 | 38 | 204 | 72 | 1200 | 1200 |

| Order Code | D20 | D21 | L20 |
|------------|-----|------|-----|
| 143.20 | 39 | 20.5 | 47 |
| 143.26 | 47 | 24.5 | 52 |
| 143.32 | 56 | 30.5 | 67 |
| 143.40 | 75 | 40.0 | 84 |
| 143.50 | 93 | 50.0 | 110 |

unbored joints

Type TS and TR joints are available without bores. Order codes for unbored versions are as indicated with the last four digits replaced by zeros. (e.g. 138.20.0000)

STEEL UNIVERSAL JOINTS (H SERIES)

standard bored joints with plain bearings

A comprehensive series of high quality universals, manufactured to DIN 808. Please call Technical Sales for alternative sizes including keywayed and square bores.

Maximum working angle is 45° for single and 90° for double joints.

Maximum speed 1500 rpm, see performance charts on page 16.

Bores listed under 'bores & order codes' are stock items. Other bores supplied to order.

These plain bearing universal joints must be lubricated.

The use of gaiters is recommended.



2

type HS single joint

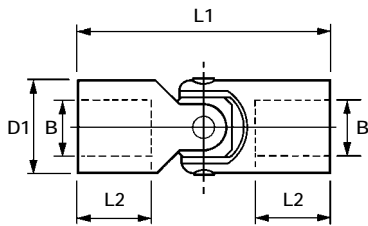

type HS double joint

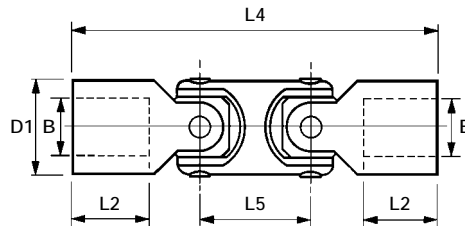

type H single gaiter

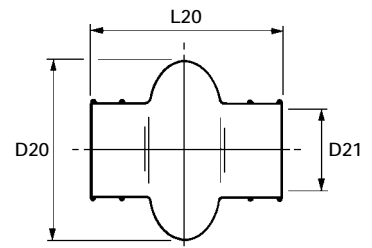

A double gaiter to suit double joints is available if required.

| Order Code | h7 Bores B | D1 | L1 | L2 | Static Torque at Break (Nm) |
|--------------|------------|----|-----|----|-----------------------------|
| 144.132.2828 | 8 × 8 | 13 | 42 | 11 | 30 |
| 144.160.2222 | 6 × 6 | 16 | 34 | 9 | 40 |
| 144.161.2828 | 8 × 8 | 16 | 40 | 11 | 40 |
| 144.162.3232 | 10 × 10 | 16 | 52 | 15 | 40 |
| 144.201.3232 | 10 × 10 | 20 | 48 | 13 | 120 |
| 144.202.3535 | 12 × 12 | 20 | 62 | 18 | 120 |
| 144.251.3535 | 12 × 12 | 25 | 56 | 15 | 220 |
| 144.252.4242 | 16 × 16 | 25 | 74 | 22 | 220 |
| 144.321.4242 | 16 × 16 | 32 | 68 | 16 | 380 |
| 144.322.4848 | 20 × 20 | 32 | 86 | 25 | 380 |
| 144.401.4848 | 20 × 20 | 40 | 82 | 23 | 800 |
| 144.402.5252 | 25 × 25 | 40 | 108 | 32 | 800 |
| 144.501.5252 | 25 × 25 | 50 | 104 | 29 | 1550 |
| 144.502.5858 | 32 × 32 | 50 | 132 | 40 | 1550 |
| 144.631.5858 | 32 × 32 | 63 | 130 | 33 | 2800 |
| 144.632.6363 | 40 × 40 | 63 | 166 | 48 | 2800 |

| Order Code | h7 Bores B | D1 | L2 | L4 | L5 | Static Torque at Break (Nm) |
|--------------|------------|----|----|-----|----|-----------------------------|
| - | - | - | - | - | - | - |
| - | - | - | - | - | - | - |
| 146.161.2828 | 8 × 8 | 16 | 11 | 62 | 22 | 40 |
| 146.162.3232 | 10 × 10 | 16 | 15 | 74 | 22 | 40 |
| 146.201.3232 | 10 × 10 | 20 | 13 | 74 | 26 | 120 |
| 146.202.3535 | 12 × 12 | 20 | 18 | 88 | 26 | 120 |
| 146.251.3535 | 12 × 12 | 25 | 15 | 86 | 30 | 220 |
| 146.252.4242 | 16 × 16 | 25 | 22 | 104 | 30 | 220 |
| 146.321.4242 | 16 × 16 | 32 | 16 | 104 | 37 | 380 |
| 146.322.4848 | 20 × 20 | 32 | 25 | 124 | 37 | 380 |
| 146.401.4848 | 20 × 20 | 40 | 23 | 128 | 47 | 800 |
| 146.402.5252 | 25 × 25 | 40 | 32 | 156 | 47 | 800 |
| 146.501.5252 | 25 × 25 | 50 | 29 | 160 | 56 | 1550 |
| 146.502.5858 | 32 × 32 | 50 | 40 | 188 | 56 | 1550 |
| 146.631.5858 | 32 × 32 | 63 | 33 | 198 | 68 | 2800 |
| 146.632.6363 | 40 × 40 | 63 | 48 | 238 | 72 | 2800 |

| Order Code | D20 | D21 | L20 |
|------------|-----|-----|-----|
| - | - | - | - |
| 153.16 | 35 | 16 | 32 |
| 153.16 | 35 | 16 | 32 |
| 153.16 | 35 | 16 | 32 |
| 153.20 | 36 | 20 | 40 |
| 153.20 | 36 | 20 | 40 |
| 153.25 | 44 | 24 | 45 |
| 153.25 | 44 | 24 | 45 |
| 153.32 | 62 | 32 | 55 |
| 153.32 | 62 | 32 | 55 |
| 153.40 | 73 | 40 | 75 |
| 153.40 | 73 | 40 | 75 |
| 153.50 | 90 | 50 | 95 |
| 153.50 | 90 | 50 | 95 |
| 153.63 | 100 | 60 | 115 |
| 153.63 | 100 | 60 | 115 |

STEEL UNIVERSAL JOINTS (H SERIES)

economy series standard bored joints with plain bearings

A series of *economical* joints for *low speed transmissions*.

They are intended only for manual operation or intermittent low speed motorised applications.

These plain bearing universal joints must be lubricated.
The use of gaiters is recommended.



type HE single joint

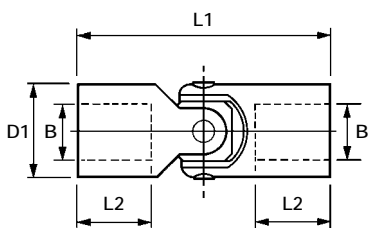

type HE double joint

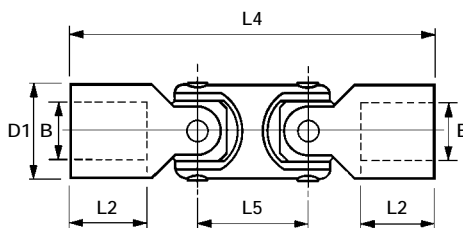

type H single gaiter

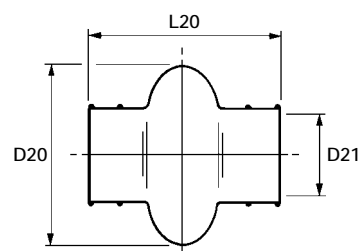

A double gaiter to suit double joints is available if required.

| Order Code | h8 Bores B | D1 | L1 | L2 | Static Torque at Break (Nm) |
|-------------|------------|----|-----|----|-----------------------------|
| 148.13.2828 | 8 × 8 | 13 | 42 | 11 | 25 |
| 148.16.3232 | 10 × 10 | 16 | 52 | 15 | 35 |
| 148.20.3535 | 12 × 12 | 20 | 62 | 18 | 90 |
| 148.25.4242 | 16 × 16 | 25 | 74 | 22 | 180 |
| 148.32.4848 | 20 × 20 | 32 | 86 | 25 | 320 |
| 148.40.5252 | 25 × 25 | 40 | 108 | 32 | 650 |
| 148.50.5858 | 32 × 32 | 50 | 132 | 40 | 1330 |

| Order Code | h8 Bores B | D1 | L2 | L4 | L5 | Static Torque at Break (Nm) |
|-------------|------------|----|----|-----|----|-----------------------------|
| - | - | - | - | - | - | - |
| 149.16.3232 | 10 × 10 | 16 | 15 | 74 | 22 | 35 |
| 149.20.3535 | 12 × 12 | 20 | 18 | 88 | 26 | 90 |
| 149.25.4242 | 16 × 16 | 25 | 20 | 104 | 30 | 180 |
| 149.32.4848 | 20 × 20 | 32 | 25 | 124 | 37 | 320 |
| 149.40.5252 | 25 × 25 | 40 | 32 | 156 | 47 | 650 |
| 149.50.5858 | 32 × 32 | 50 | 40 | 188 | 56 | 1300 |

| Order Code | D20 | D21 | L20 |
|------------|-----|-----|-----|
| - | - | - | - |
| 153.16 | 35 | 16 | 32 |
| 153.20 | 36 | 20 | 40 |
| 153.25 | 44 | 24 | 45 |
| 153.32 | 62 | 32 | 55 |
| 153.40 | 73 | 40 | 75 |
| 153.50 | 90 | 50 | 95 |

PERFORMANCE DATA (T SERIES)

types TL & TS, plain bearings – 1200 rpm max
 – 200 rpm for sizes 60-100

(Please note that the nomograms do not apply to joints assembled as telescopic drive shafts)

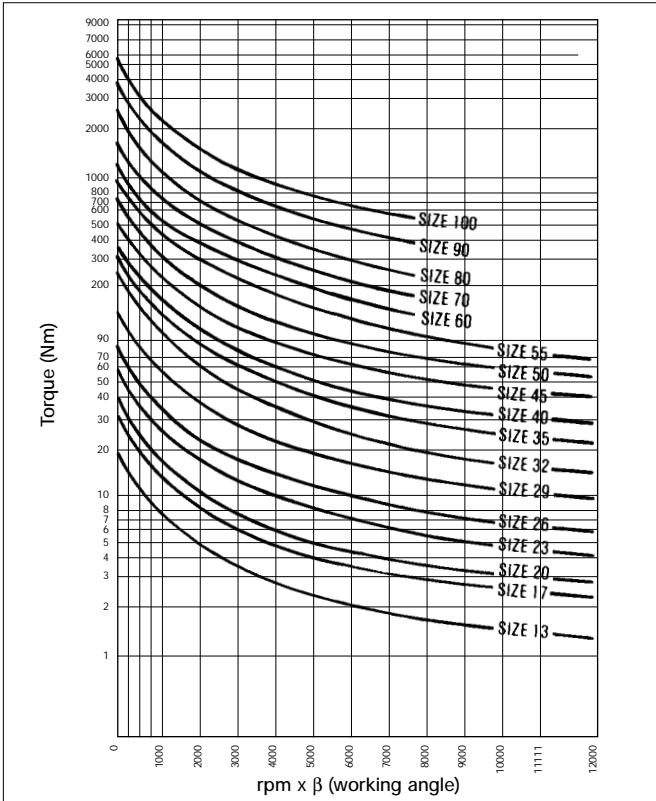

| Operating conditions | Table A rpm x beta 250 or less | | | Table B more than 250 | | |
|-----------------------------|-----------------------------------|-----|-----|--------------------------|-----|-----|
| | < 3 | 8 | > 8 | < 3 | 8 | > 8 |
| hrs per day | | | | | | |
| Uniform load SF | 2.5 | 3.0 | 3.5 | 3.0 | 3.6 | 4.0 |
| Intermittent load SF | 3.0 | 3.5 | 4.0 | 3.6 | 4.0 | 5.0 |
| Severe Intermittent load SF | 3.5 | 4.0 | 4.5 | 4.0 | 5.0 | 6.0 |

using the nomogram

The nomogram charts the maximum dynamic moment for each size of joint. The curves represent the limit of performance and must not be exceeded, however momentarily, by peak impulse loads.

The product of speed of rotation x working angle is given for values from 250–12000. The upper speed limit for this series is 1200 rpm and this corresponds to a maximum working angle of 10° at this speed.

Working angles up to 45° are practicable provided the corresponding speeds are held within the limits of the nomogram. A double joint working at 90° is considered the equivalent of two singles working at 45°.

selection

1. Determine the driving torque of the application in Newton metres (Nm) and the speed of rotation in revolutions per minute (rpm).
 If converting from other units:

$$1 \text{ lbf ft} = 1.36 \text{ Nm}$$

$$1 \text{ kpm} = 9.81 \text{ Nm}$$

The relationship between driving torque, speed of rotation and power transmitted is expressed by the formulæ:

$$\text{torque (Nm)} = \frac{7120 \times \text{HP}}{\text{rpm}} \quad \text{or} \quad \frac{9550 \times \text{kW}}{\text{rpm}}$$

2. Find the product of rpm x working angle (beta) and select the appropriate service factor (SF) from table A or B after identifying the nature of the loading on the transmission.

'Uniform' loads – typically electric motors driving fans, centrifugal pumps or conveyors under constant load conditions.

'Intermittent' loads – presses, shears, radial displacement pumps or compressors, all driven by electric motors.

'Severe Intermittent' loads – typically rolling mills or crushers or 'intermittent' type loads driven by I.C. motors with less than 4 cylinders.

3. If table A is relevant, multiply Nm x SF and select a joint with a static torque figure in excess of this value.

If table B is relevant, apply the products of Nm x SF and rpm x beta to the nomogram and select the joint with the performance curve immediately above the point of intersection.

type TR, needle roller bearings – 6000 rpm max
 – 3000 rpm for sizes 40 and 50

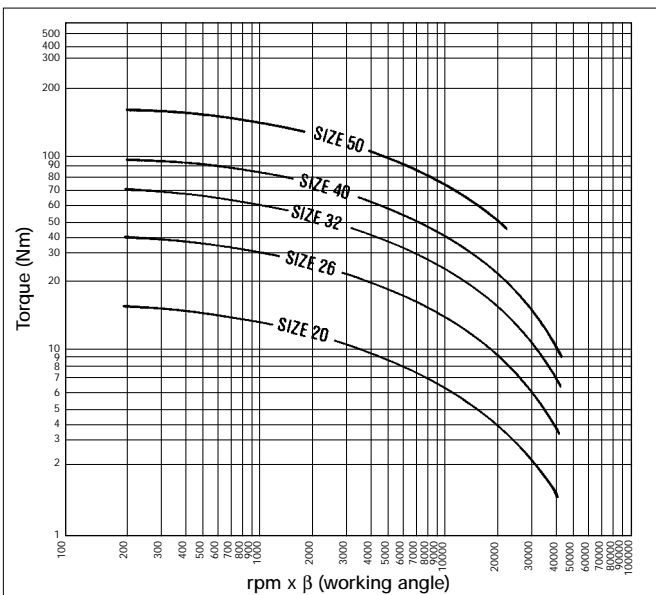

using the nomogram

The nomogram charts the maximum dynamic moment for each size of joint. The curves represent the limit of performance and must not be exceeded, however momentarily, by peak impulse loads.

The product of speed of rotation x working angle is given for values from 200–40000. The upper speed limit for this series is 6000 rpm and this corresponds to a maximum working angle of 6° 30' at this speed.

Working angles up to 45° are practicable provided the corresponding speeds are held within the limits of the nomogram. A double joint working at 90° is considered the equivalent of two singles working at 45°.

selection

1. Determine the driving torque of the application in Newton metres (Nm) and the speed of rotation in revolutions per minute (rpm)
2. Find the product of rpm x working angle (beta) and check that the result is within the limits of the nomogram.
3. Apply the values obtained in 1) and 2) to the nomogram and select the joint with the performance curve immediately above the point of intersection. Normal safety factors are built into the nomogram which is based on tests conducted with joints operating under arduous conditions.

PERFORMANCE DATA (H SERIES)

type HS, plain bearings – 1500 rpm max

(Please note that the nomograms do not apply to joints assembled as telescopic drive shafts)

2

selecting joint size

The correct joint size for a given application can be determined after establishing the following criteria:

- Torque or power to be transmitted
- Speed of rotation
- Maximum working angle
- Fluctuations in load or prime mover output

using the nomogram

The nomogram is expressed Nm and is valid for the continuous transmission of a constant or near constant load where the product of speed (rpm) × working angle exceeds 300. The curves are valid for working angles up to 5°. Where use is intermittent, the stated values for transmissible torque can be increased by 20% or conversely, the calculated values in the following examples could be reduced by 16%. In marginal cases, this would allow the selection of a smaller joint.

In addition to torque and speed of rotation, the working angle of the joint has a bearing on its selection. The larger the working angle, the higher the 'effective' load through the joint.

The factors tabled below will make the necessary correction as shown in the following examples.

Correction Factors

| Working Angle | 10° | 15° | 20° | 25° | 30° | 35° | 40° |
|-------------------|------|------|------|------|------|------|------|
| Correction Factor | 0.92 | 0.84 | 0.75 | 0.63 | 0.45 | 0.30 | 0.10 |

If converting from other units:

- 1 kW = 1.341 HP
- 1 lbf ft = 1.356 Nm

Example 1

- Transmitted torque: 50lbf ft (68 Nm)
- Speed of rotation: 500 rpm
- Working angle: 20°
- Correction factor (from table): 0.75
- ∴ corrected torque = $\frac{68}{0.75} = 91 \text{ Nm}$

Select the joint with the performance curve at or immediately above the point of intersection of the horizontal corresponding to 91 Nm and the vertical corresponding to 500 rpm, i.e. Joint Size 40. Note that the length of the joint has no bearing on this calculation.

Example 2

- Power rating: 3.5 HP or (2.6 kW)
- Speed of rotation: 400 rpm
- Working angle: 30°
- Correction factor (from table): 0.45
- ∴ corrected torque = $\frac{3.5}{0.45} = 7.8 \text{ HP or (5.8 kW)}$

The power rating (HP or kW) must first be resolved to torque x rpm in order to address the nomogram.

$$\begin{aligned} \text{i.e. torque (Nm)} &= \frac{712 \times \text{HP}}{\text{rpm}} \text{ or } \left(\frac{9550 \times \text{kW}}{\text{rpm}} \right) \\ &= \frac{712 \times 7.8}{400} \\ &= 139 \text{ Nm} \end{aligned}$$

Select the joint with the performance curve at or immediately above the point of intersection of the horizontal corresponding to 139 Nm and the vertical corresponding to 400 rpm, i.e. Joint Size 50. Once again, the length of the joint has no bearing on this calculation.

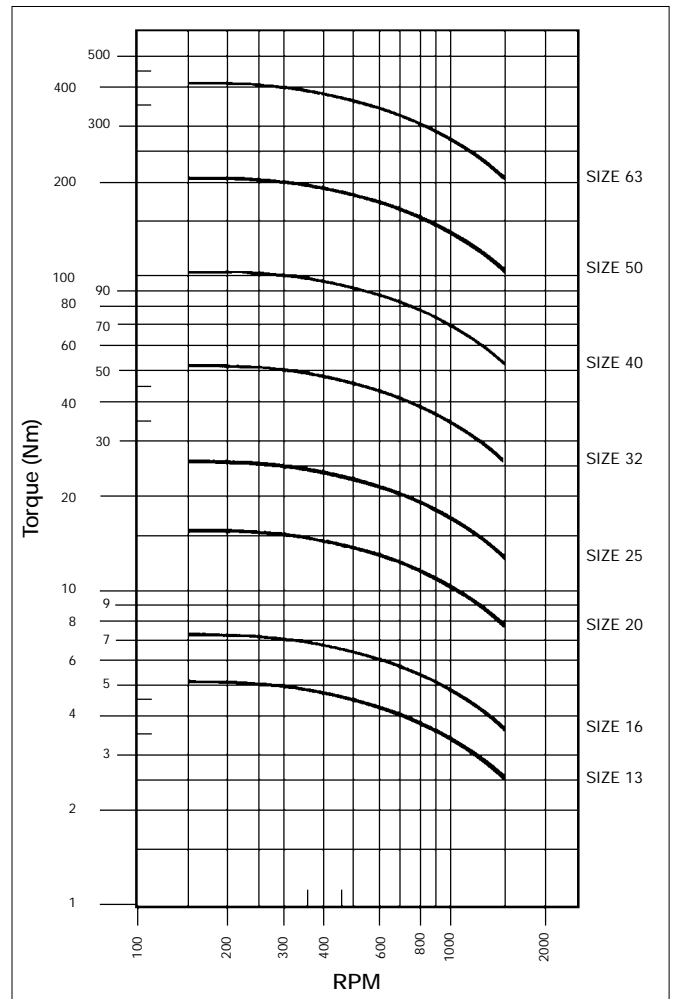

Low Speed/Low Working Angle

If the product of speed (rpm) × working angle is less than 300 the following method will determine an appropriate joint size.

1. Establish the torque in Nm
2. Determine the maximum working angle of the joint
3. Substitute these values in the corresponding formula:

$$\begin{aligned} \text{For intermittent use} &= \frac{500 \times \text{torque}}{(100 - \text{working angle})} \\ \text{For continuous use} &= \frac{600 \times \text{torque}}{(100 - \text{working angle})} \end{aligned}$$

4. Select a joint with a static break torque in excess of the figure obtained.

Example 3

- Transmitted torque: 50 Nm
- Speed of rotation: Manual (intermittent)
- Max. Working angle: 25°
- ∴ torque rating = $\frac{500 \times 50}{(100 - 25)} = \frac{25000}{75} = 333 \text{ Nm}$

Type HS joint size 32 (static torque 380 Nm) or type HE joint size 40 (static torque 650 Nm) should be selected.

MINIATURE STEEL UNIVERSAL JOINTS

miniature
standard bored joints with plain bearings

type M

A range of good quality miniature universal joints suitable for motorised applications up to 500 rpm.

Also available in stainless steel to special order.

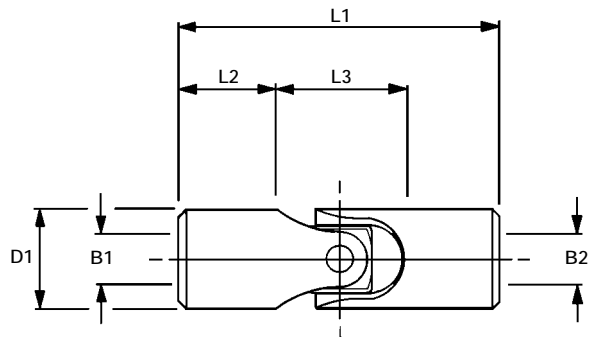

| Order Code | Bores | | D1 | L1 | L2 | L3 | weight g |
|-------------|-------------|--|------|------|-----|------|-------------|
| | B1 × B2 | | | | | | |
| 177.06.1414 | 3.00 × 3.00 | | 6.0 | 18.0 | 5.5 | 7.0 | 3.0 |
| 177.08.1818 | 4.00 × 4.00 | | 8.0 | 24.0 | 7.2 | 9.6 | 7.1 |
| 177.10.2020 | 5.00 × 5.00 | | 10.0 | 30.0 | 9.0 | 12.0 | 12.5 |

miniature
steel telescopic drive shaft assemblies



Special assemblies made to order.

sub-miniature
steel universal joints

type SM



| Order Code | Bores | | D1 | L1 | L2 | L3 |
|-------------|-----------|--|-----|------|-----|-----|
| | B1 × B2 | | | | | |
| 178.03.V203 | 1.5 × 1.5 | | 3.0 | 12.0 | 4.0 | 4.0 |
| 178.04.V204 | 2.0 × 2.0 | | 4.0 | 14.0 | 4.5 | 5.0 |
| 178.05.V205 | 2.5 × 2.5 | | 5.0 | 15.0 | 4.5 | 6.0 |

Please call Technical Sales for performance data relating to type M and type SM universal joints.

SPECIAL JOINTS & TELESCOPES

The universal joints featured in this catalogue can be specified with non-stock bores and to special dimensions. Any of the listed joint sizes can be built as telescopic drive shafts. See next page.

Please enter all relevant details on a photocopy of this page and attach your company letterhead with your name, title and extension number for a quotation. Please use a separate photocopy for each component.

2

Please quote pcs single joint TYPE SIZE Ø

*Needle Roller
Plain Bearing

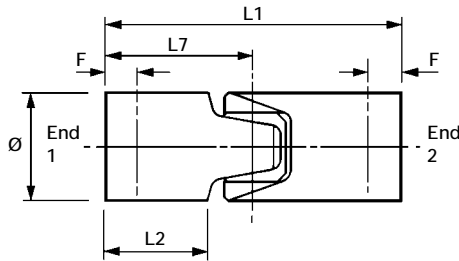

for standard. Specify dimensions only if absolutely necessary.

Overall length L1
Half length L7

Where specified, keyways will be spaced at 90°.

*Delete where appropriate

Please quote pcs single joint TYPE SIZE Ø.....

*Needle Roller
Plain

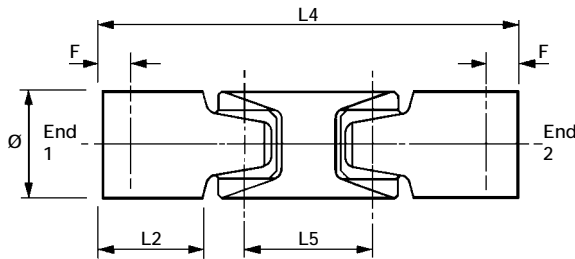

for standard. Specify dimensions only if absolutely necessary.

Overall length L4
Shackle Centres L5

Where specified, keyways will be spaced in line unless requested, otherwise at 180°.

*Delete where appropriate

bore details end 1

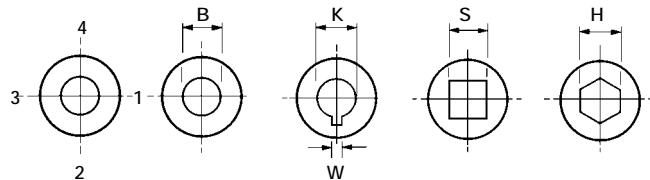
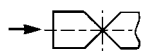

cross hole positions 1, 2, 3, 4

Enter dimension required or if standard

Plain Bore B dia
Keywayed Bore K dia
Key width W (standard is to BS 4235 Part 1)
Square Bore S A/F
Hex Bore H A/F
Bore depth L2
Tapped hole at posn & posn Tapped
Cross hole at posn & posn dia
Cross Hole datum F

bore details end 2

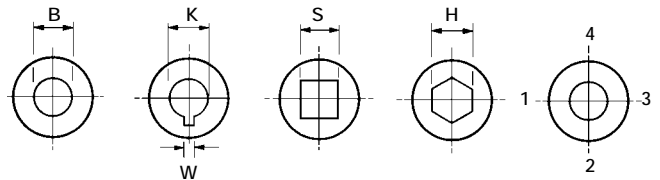
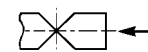

cross hole positions 1, 2, 3, 4

Enter dimension required or if standard

Plain Bore B dia
Keywayed Bore K dia
Key width W (standard is to BS 4235 Part 1)
Square Bore S A/F
Hex Bore H A/F
Bore depth L2
Tapped hole at posn & posn Tapped
Cross hole at posn & posn dia
Cross Hole datum F

TELESCOPIC DRIVE SHAFTS

The universal joints featured in this catalogue can be specified with non-stock bores and to special dimensions and be built as telescopic drive shafts.

Please enter all relevant details on a photocopy of this page and attach your company letterhead with your name, title and extension number for a quotation. Please use a separate photocopy for each component.

Please quote pcs telescope based on joint TYPE SIZE Ø *Needle Roller joint Plain

*Delete where appropriate

Min retracted length V
 Max extended length V1

Where specified, keyways will be spaced in line unless requested, otherwise at 180°.

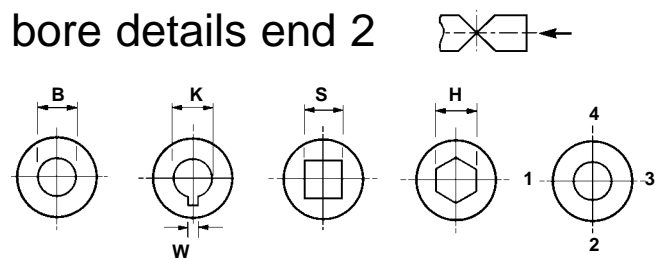
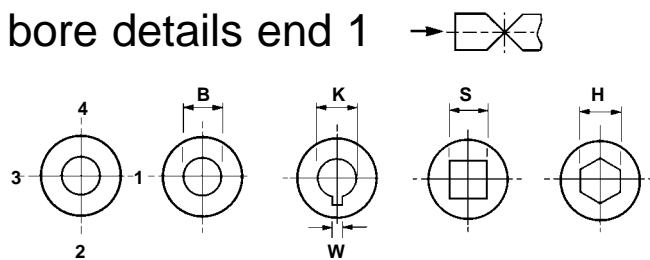
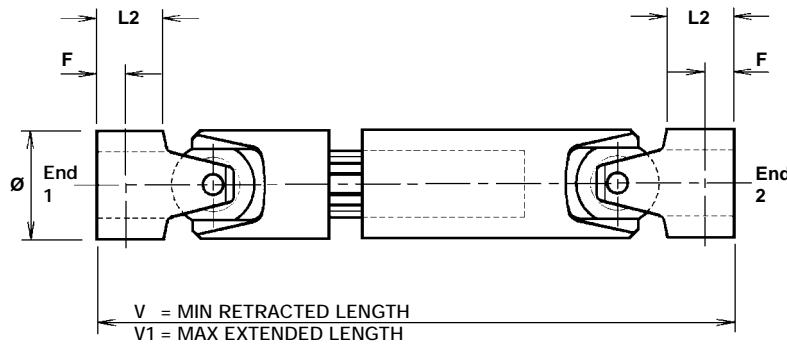

Enter dimension required or if standard

Plain Bore B dia
 Keywayed Bore K dia
 Key width W (standard is to BS 4235 Part 1)
 Square Bore S A/F
 Hex Bore H A/F
 Bore depth L2
 Tapped hole at posn & posn Tapped
 Cross hole at posn & posn dia
 Cross Hole datum F

Plain Bore B dia
 Keywayed Bore K dia
 Key width W (standard is to BS 4235 Part 1)
 Square Bore S A/F
 Hex Bore H A/F
 Bore depth L2
 Tapped hole at posn & posn Tapped
 Cross hole at posn & posn dia
 Cross Hole datum F

QUALITY PRODUCTS



DELIVERY WHEN
YOU NEED IT



HUCO SUPPORT