

NPT³ IGBT

in ISOPLUS 247™

$I_{C25} = 95 \text{ A}$
 $V_{CES} = 1200 \text{ V}$
 $V_{CE(sat) \text{ typ.}} = 2.1 \text{ V}$

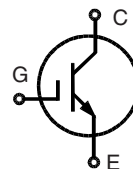

ISOPLUS 247™
E153432

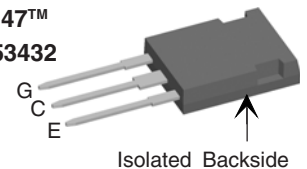

G = Gate C = Collector E = Emitter

IGBT		
Symbol	Conditions	Maximum Ratings
V_{CES}	$T_{VJ} = 25^{\circ}\text{C to } 150^{\circ}\text{C}$	1200 V
V_{GES}		± 20 V
I_{C25}	$T_C = 25^{\circ}\text{C}$	95 A
I_{C90}	$T_C = 90^{\circ}\text{C}$	60 A
I_{CM} V_{CEK}	$V_{GE} = \pm 15 \text{ V}; R_G = 22 \Omega; T_{VJ} = 125^{\circ}\text{C}$ RBSOA, Clamped inductive load; $L = 100 \mu\text{H}$	100 A
t_{SC} (SCSOA)		$V_{CE} = 900 \text{ V}; V_{GE} = \pm 15 \text{ V}; R_G = 22 \Omega; T_{VJ} = 125^{\circ}\text{C}$ non-repetitive
P_{tot}	$T_C = 25^{\circ}\text{C}$	375 W

Features

- NPT³ IGBT
 - low saturation voltage
 - positive temperature coefficient for easy paralleling
 - fast switching
 - short tail current for optimized performance in resonant circuits
- ISOPLUS 247™ package
 - isolated back surface
 - low coupling capacity between pins and heatsink
 - high reliability
 - industry standard outline

Symbol	Conditions	Characteristic Values ($T_{VJ} = 25^{\circ}\text{C}$, unless otherwise specified)			
		min.	typ.	max.	
$V_{CE(sat)}$	$I_C = 60 \text{ A}; V_{GE} = 15 \text{ V}; T_{VJ} = 25^{\circ}\text{C}$ $T_{VJ} = 125^{\circ}\text{C}$	2.1	2.7	V	
$V_{GE(th)}$	$I_C = 2 \text{ mA}; V_{GE} = V_{CE}$	4.5		6.5 V	
I_{CES}	$V_{CE} = V_{CES}; V_{GE} = 0 \text{ V}; T_{VJ} = 25^{\circ}\text{C}$ $T_{VJ} = 125^{\circ}\text{C}$	0.1		0.1 mA	
I_{GES}	$V_{CE} = 0 \text{ V}; V_{GE} = \pm 20 \text{ V}$			200 nA	
$t_{d(on)}$ t_r $t_{d(off)}$ t_f	Inductive load, $T_{VJ} = 125^{\circ}\text{C}$ $V_{CE} = 600 \text{ V}; I_C = 60 \text{ A}$ $V_{GE} = \pm 15 \text{ V}; R_G = 22 \Omega$	80		ns	
E_{on}			50		ns
E_{off}			680		ns
			30		ns
C_{ies}	$V_{CE} = 25 \text{ V}; V_{GE} = 0 \text{ V}; f = 1 \text{ MHz}$	3.8		nF	
Q_{Gon}	$V_{CE} = 600 \text{ V}; V_{GE} = 15 \text{ V}; I_C = 50 \text{ A}$	350		nC	
R_{thJC} R_{thJH}		0.66		0.33 KW KW	

Applications

- single switches and with complementary free wheeling diodes
- choppers
- phaselegs, H bridges, three phase bridges e.g. for
 - power supplies, UPS
 - AC, DC and SR drives
 - induction heating

Component

Symbol	Conditions	Maximum Ratings	
T_{VJ}		-55...+150	°C
T_{stg}		-55...+125	°C
V_{ISOL}	$I_{ISOL} \leq 1 \text{ mA}; 50/60 \text{ Hz}$	2500	V~
F_c	mounting force with clip	20...120	N

Symbol	Conditions	Characteristic Values		
		min.	typ.	max.
C_p	coupling capacity between shorted pins and mounting tab in the case		30	pF
Weight			6	g

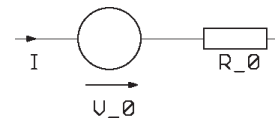
Equivalent Circuits for Simulation
Conduction

IGBT (typ. at $V_{GE} = 15 \text{ V}; T_J = 125^\circ\text{C}$)
 $V_0 = 0.99 \text{ V}; R_0 = 25 \text{ m}\Omega$

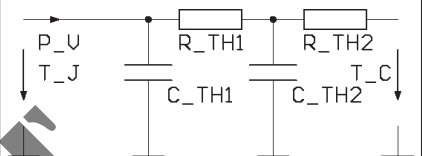
Thermal Response

IGBT (typ.)

$C_{th1} = 0.13 \text{ J/K}; R_{th1} = 0.06 \text{ K/W}$
 $C_{th2} = 0.32 \text{ J/K}; R_{th2} = 0.27 \text{ K/W}$

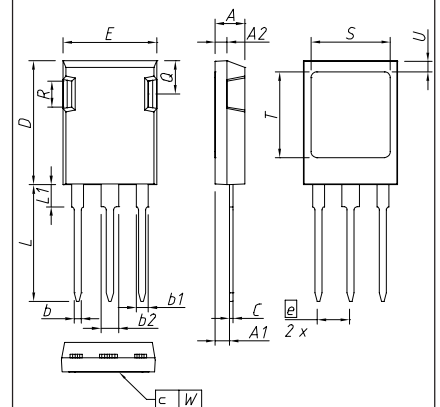
ISOPLUS247™ OUTLINE

DIM.	MILLIMETER		INCHES	
	MIN	MAX	MIN	MAX
A	4,83	5,21	0,190	0,205
A1	2,29	2,54	0,090	0,100
A2	1,91	2,16	0,075	0,085
b	1,14	1,40	0,045	0,055
b1	1,91	2,15	0,075	0,085
b2	2,92	3,20	0,115	0,126
C	0,61	0,83	0,024	0,033
D	20,80	21,34	0,819	0,840
E	15,75	16,13	0,620	0,635
e	5,45 BSC		0,215 BSC	
L	19,81	20,60	0,780	0,811
L1	3,81	4,38	0,150	0,172
Q	5,59	6,20	0,220	0,244
R	4,32	4,85	0,170	0,191
S	13,21	13,72	0,520	0,540
T	15,75	16,26	0,620	0,640
U	1,65	2,03	0,065	0,080
W	-	0,10	-	0,004

The convex bow of substrate is typ. < 0.04 mm over plastic surface level of device bottom side
 This drawing will meet all dimensions requirement of JEDEC outline TO-247 AD except screw hole and except Lmax.

PHASE-OUT

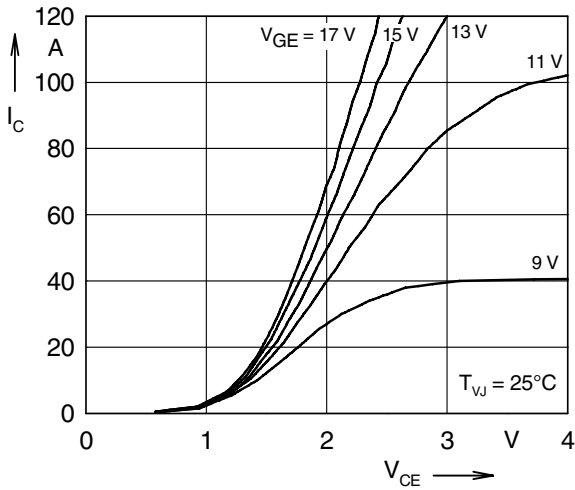

Fig. 1 Typ. output characteristics

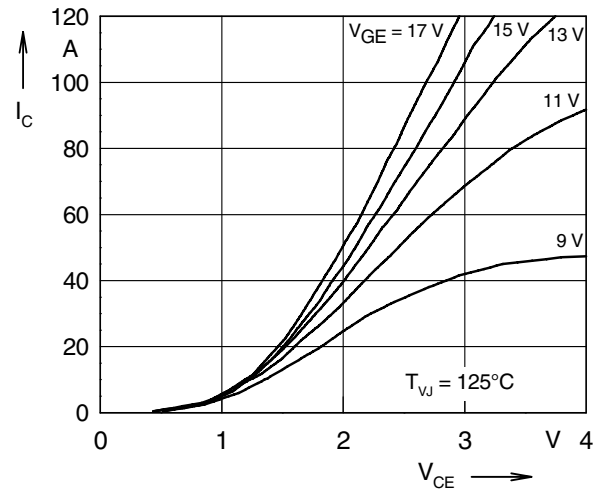

Fig. 2 Typ. output characteristics

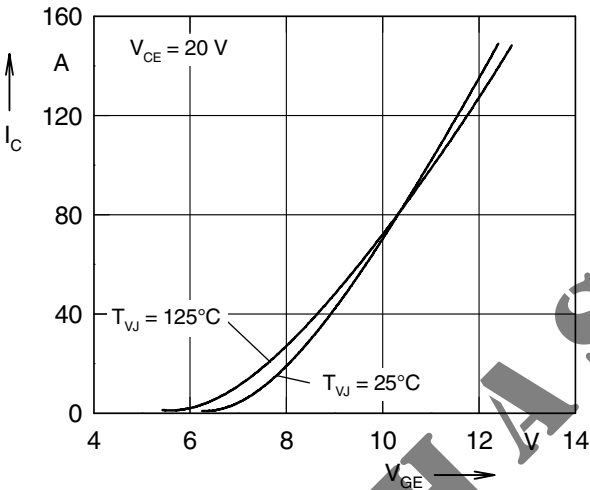

Fig. 3 Typ. transfer characteristics

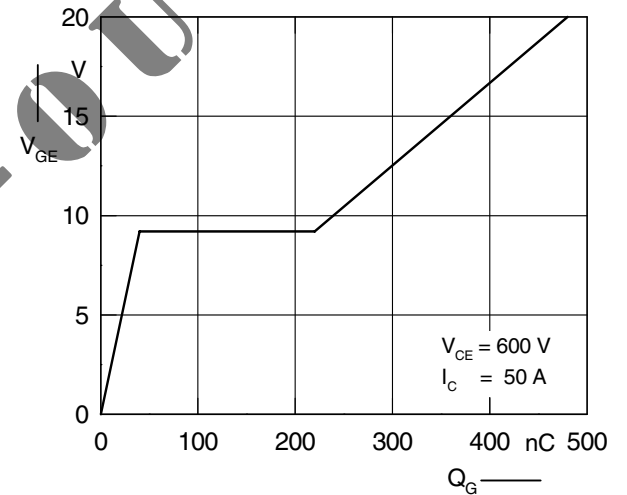

Fig. 4 Typ. turn on gate charge

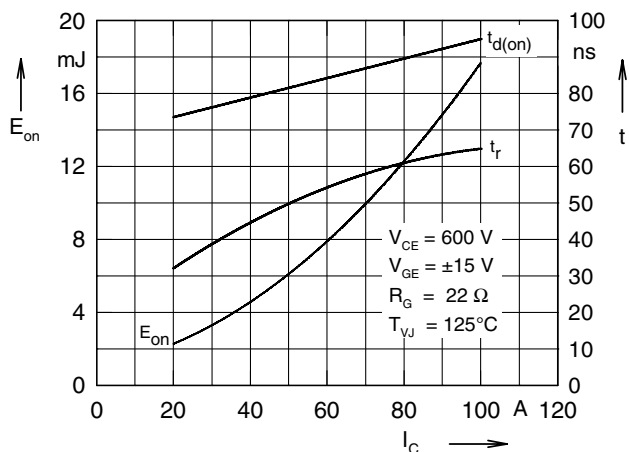

Fig. 5 Typ. turn on energy and switching times versus collector current

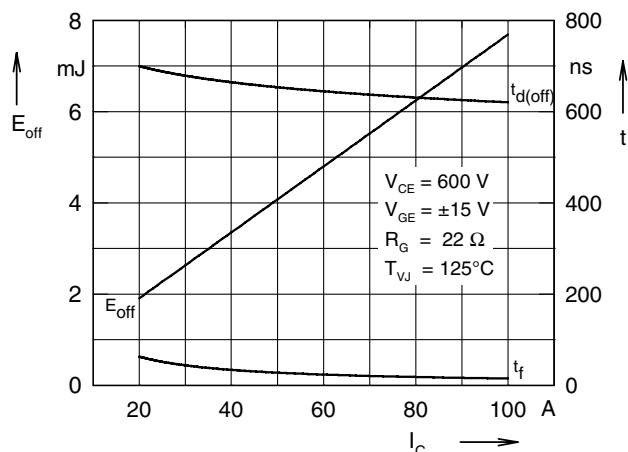

Fig. 6 Typ. turn off energy and switching times versus collector current

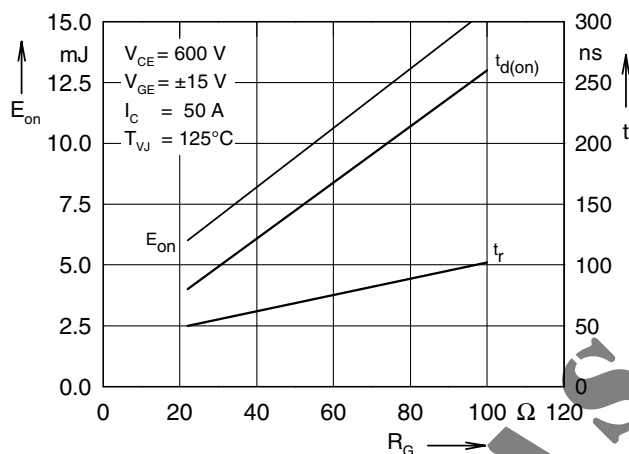

Fig. 7 Typ. turn on energy and switching times versus gate resistor

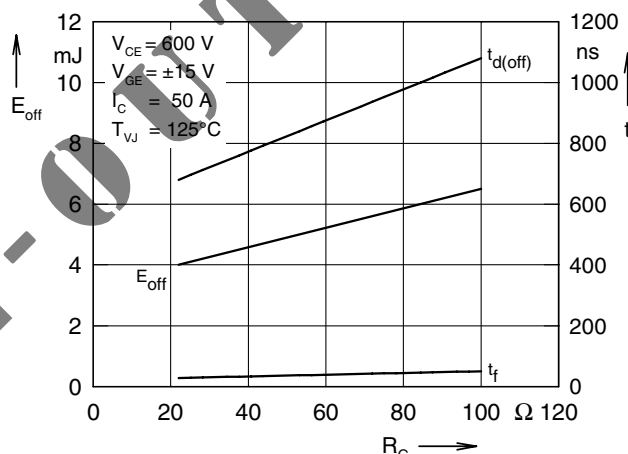

Fig. 8 Typ. turn off energy and switching times versus gate resistor

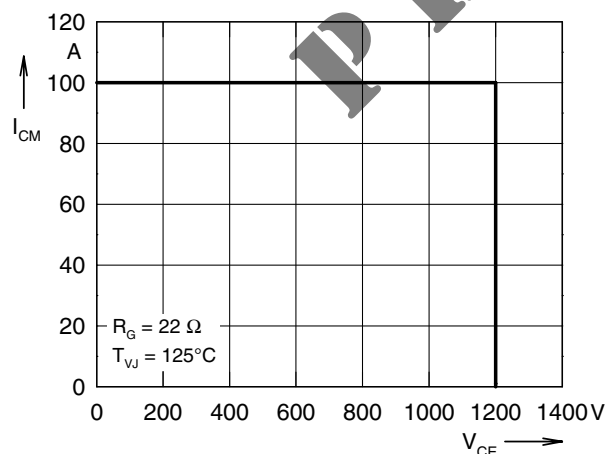

Fig. 9 Reverse biased safe operating area RBSOA

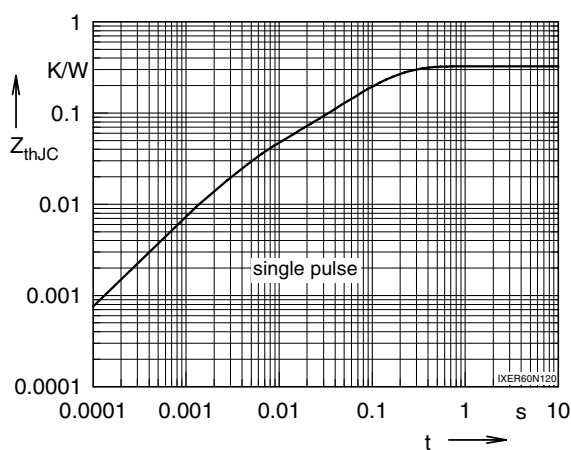

Fig. 10 Typ. transient thermal impedance