

T-52-11-00

CD4049A, CD4050A Types

CMOS Hex Buffer/Converters

CD4049A—Inverting Type
CD4050A—Non-Inverting Type

RECOMMENDED OPERATING CONDITIONS at $T_A=25^\circ\text{C}$, Except as Noted.
For maximum reliability, nominal operating conditions should be selected so that operation is always within the following ranges:

| CHARACTERISTIC | LIMITS | | UNITS |
|---|------------|------|-------|
| | Min. | Max. | |
| Supply-Voltage Range (V_{CC}) (For T_A =Full Package-Temperature Range) | 3 | 12 | V |
| Input Voltage Range (V_I) | V_{CC}^* | 12 | V |

*The CD4049 and CD4050 have high-to-low-level voltage conversion capability but not low-to-high-level; therefore it is recommended that $V_I \geq V_{CC}$.

The CD4049A and CD4050A are inverting and non-inverting hex buffers, respectively, and feature logic-level conversion using only one supply voltage (V_{CC}). The input-signal high level (V_{IH}) can exceed the V_{CC} supply voltage when these devices are used for logic-level conversions. These devices are intended for use as CMOS to DTL/TTL converters and can drive directly two DTL/TTL loads. ($V_{CC}=5\text{ V}$, $V_{OL} \geq 0.4\text{ V}$, and $I_{DN} \geq 3.2\text{ mA}$.)

The CD4049A and CD4050A are designated as replacements for CD4009A and CD4010A, respectively. Because the CD4049A and CD4050A require only one power supply, they are preferred over the CD4009A and CD4010A and should be used in place of the CD4009A and CD4010A in all inverter, current driver, or logic-level conversion applications. In these applications the CD4049A and CD4050A are pin compatible with the CD4009A and CD4010A respectively, and can be substituted for these devices in existing as well as in new designs. Terminal No. 16 is not connected internally on the CD4049A or CD4050A, therefore, connection to this terminal is of no consequence to circuit operation. For applications not requiring high sink-current or voltage conversion, the CD4069 Hex Inverter is recommended.

These types are supplied in 16-lead hermetic dual-in-line ceramic packages (D and F suffixes), 16-lead dual-in-line plastic package (E suffix), 16-lead ceramic flat packages (K suffix), and in chip form (H suffix).

Features:

- High sink current for driving 2 TTL loads
- High-to-low level logic conversion
- Quiescent current specified to 15 V
- Maximum input leakage of $1\ \mu\text{A}$ at 15 V (full package-temperature range)

Applications:

- CMOS to DTL/TTL hex converter
- CMOS current "sink" or "source" driver
- CMOS high-to-low logic-level converter

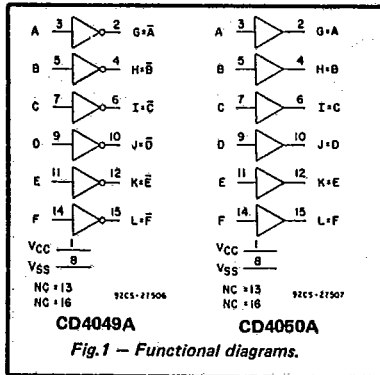

STATIC ELECTRICAL CHARACTERISTICS

| Characteristic | Conditions | | | Limits at Indicated Temperatures ($^\circ\text{C}$) | | | | | | | | Units |
|---|--------------|-----------------|-----------------|---|-------|-------|-------|-----------|-------|-------|------|---------------|
| | | | | D, F, K, H Packages | | | | E Package | | | | |
| | V_O (V) | V_{IN} (V) | V_{CC} (V) | -55 | +25 | | +125 | -40 | +25 | | +85 | |
| Quiescent Device Current, I_Q Max. | - | - | 5 | 0.3 | 0.01 | 0.3 | 20 | 3 | 0.03 | 3 | 42 | μA |
| | - | - | 10 | 0.5 | 0.01 | 0.5 | 30 | 5 | 0.05 | 5 | 70 | |
| | - | - | 15 | 10 | 0.02 | 10 | 100 | 50 | 0.05 | 50 | 500 | |
| Output Voltage: V_{OL} Low-Level, V_{OH} High-Level, V_{OH} | - | 0, 5 | 5 | 0 Typ.; 0.05 Max. | | | | | | | | V |
| | - | 0, 10 | 10 | 0 Typ.; 0.05 Max. | | | | | | | | |
| | - | 0, 5 | 5 | 4.95 Min.; 5 Typ. | | | | | | | | |
| | - | 0, 10 | 10 | 9.95 Min.; 10 Typ. | | | | | | | | |
| Noise Immunity: Inputs Low, V_{NL} CD4050A, Inputs High, V_{NH} All Types, Inputs Low, V_{NL} CD4049A | 3.6 | - | 5 | 1.5 Min.; 2.25 Typ. | | | | | | | | V |
| | 7.2 | - | 10 | 3 Min.; 4.5 Typ. | | | | | | | | |
| | 1.4 | - | 5 | 1.5 Min.; 2.25 Typ. | | | | | | | | |
| | 2.8 | - | 10 | 3 Min.; 4.5 Typ. | | | | | | | | |
| | 3.6 | - | 5 | 1 Min.; 1.5 Typ. | | | | | | | | |
| | 7.2 | - | 10 | 2 Min.; 3 Typ. | | | | | | | | |
| Noise Margin: Inputs Low, V_{NML} Min. CD4050A, Inputs High, V_{NMH} Min. CD4050A | 4.5 | - | 5 | 1 Min. | | | | | | | | V |
| | 9 | - | 10 | 1 Min. | | | | | | | | |
| | 0.5 | - | 5 | 1 Min. | | | | | | | | |
| | 1 | - | 10 | 1 Min. | | | | | | | | |
| Output Drive Current: N-Channel (Sink), I_{DN} Min., P-Channel (Source), I_{DP} Min. | 0.4 | - | 4.5 | 3.3 | 5.2 | 2.6 | 1.8 | 3.1 | 5.2 | 2.6 | 2.1 | mA |
| | 0.4 | - | 5 | 3.75 | 6 | 3 | 2.1 | 3.6 | 6 | 3 | 2.5 | |
| | 0.5 | - | 10 | 10 | 16 | 8 | 5.6 | 9.6 | 16 | 8 | 6.6 | |
| | 4.5 | - | 5 | -0.62 | -1 | -0.5 | -0.35 | -0.6 | -1 | -0.5 | -0.4 | |
| | 2.5 | - | 5 | -1.85 | -2.5 | -1.25 | -0.9 | -1.5 | -2.5 | -1.25 | -1 | |
| 9.5 | - | 10 | -1.85 | -2.5 | -1.25 | -0.9 | -1.5 | -2.5 | -1.25 | -1 | | |
| Input Leakage Current, I_{IL} , I_{IH} Max. | Any Input | | 15 | $\pm 10^{-5}$ Typ., ± 1 Max. | | | | | | | | μA |

CD4049A, CD4050A Types

MAXIMUM RATINGS, Absolute-Maximum Values:

| | |
|---|---------------------------------------|
| STORAGE-TEMPERATURE RANGE (T_{stg}) | -65 to +150°C |
| OPERATING-TEMPERATURE RANGE (T_A): | |
| PACKAGE TYPES D, F, K, H | -55 to +125°C |
| PACKAGE TYPE E | -40 to +85°C |
| DC SUPPLY-VOLTAGE RANGE, (V_{CC}) | |
| (Voltages referenced to V_{SS} Terminal) | -0.5 to +15 V |
| POWER DISSIPATION PER PACKAGE (P_D): | |
| FOR $T_A = -40$ to +60°C (PACKAGE TYPE E) | 500 mW |
| FOR $T_A = +60$ to +85°C (PACKAGE TYPE E) | Derate Linearly at 12 mW/°C to 200 mW |
| FOR $T_A = -55$ to +100°C (PACKAGE TYPES D, F, K) | 500 mW |
| FOR $T_A = +100$ to +125°C (PACKAGE TYPES D, F, K) | Derate Linearly at 12 mW/°C to 200 mW |
| DEVICE DISSIPATION PER OUTPUT TRANSISTOR | |
| FOR $T_A =$ FULL PACKAGE-TEMPERATURE RANGE (ALL PACKAGE TYPES) | 100 mW |
| INPUT VOLTAGE RANGE, ALL INPUTS | -0.5 to $V_{DD} + 0.5$ V |
| LEAD TEMPERATURE (DURING SOLDERING): | |
| At distance 1/16 ± 1/32 inch (1.59 ± 0.79 mm) from case for 10 s max. | +265°C |

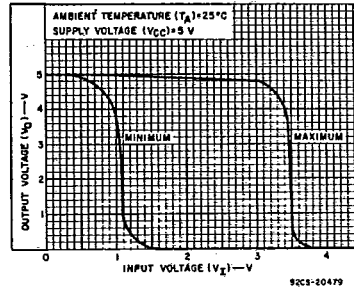

Fig. 2—Minimum and maximum voltage transfer characteristics for CD4049A.

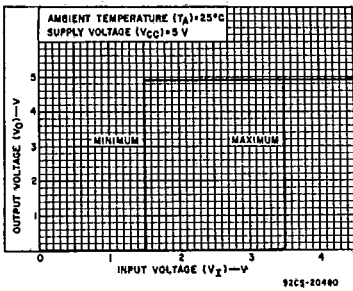

Fig. 3—Minimum and maximum voltage transfer characteristics for CD4050A.

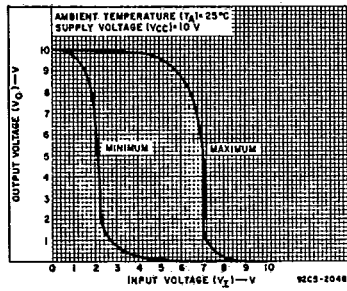

Fig. 4—Minimum and maximum voltage transfer characteristics for CD4049A.

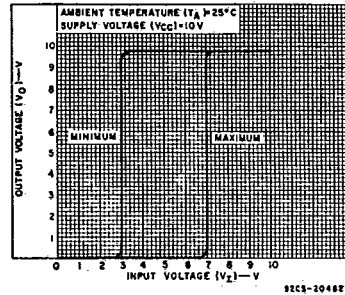

Fig. 5—Minimum and maximum voltage transfer characteristics for CD4050A.

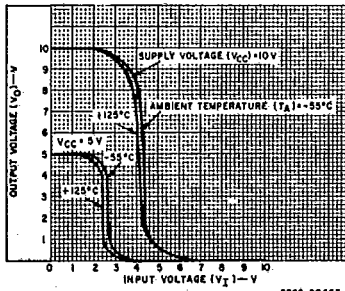

Fig. 6—Typical voltage transfer characteristics as a function of temperature for CD4049A.

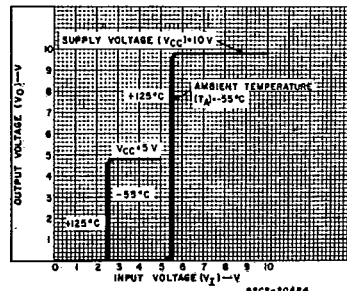

Fig. 7—Typical voltage transfer characteristics as a function of temperature for CD4050A.

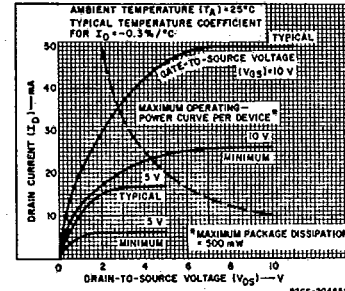

Fig. 8—Typical and minimum n-channel drain characteristics as a function of gate-to-source voltage (V_{GS}) for CD4049A, CD4050A.

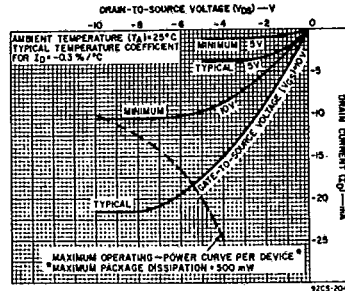

Fig. 9—Typical and minimum p-channel drain characteristics as a function of gate-to-source voltage (V_{GS}) for CD4049A, CD4050A.

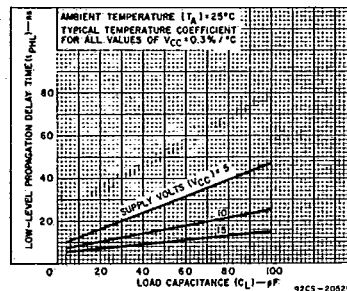

Fig. 10—Typical high-to-low level propagation delay time vs. C_L for CD4049A.

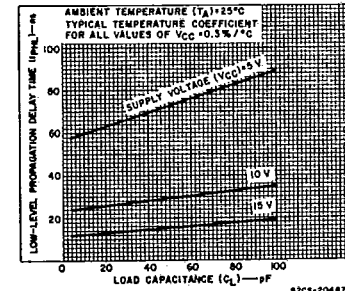

Fig. 11—Typical high-to-low level propagation delay time vs. C_L for CD4050A.

CD4049A, CD4050A Types

DYNAMIC ELECTRICAL CHARACTERISTICS at $T_A=25^\circ\text{C}$; Input $t_r, t_f=20\text{ ns}$, $C_L=15\text{ pF}$, $R_L=200\text{ k}\Omega$

| CHARACTERISTIC | CONDITIONS | | LIMITS ALL PKGS. | | UNITS |
|---|------------|----------|------------------|------|-------|
| | V_I | V_{CC} | Typ. | Max. | |
| Propagation Delay Time: Low-to-High, t_{PLH} | 5 | 5 | 50 | 80 | ns |
| | | 10 | 25 | 55 | |
| | 10 | 5 | 75 | 140 | |
| | | 10 | 35 | 85 | |
| High-to-Low, t_{PHL} | 5 | 5 | 15 | 55 | ns |
| | | 10 | 10 | 30 | |
| | 10 | 5 | 55 | 110 | |
| | | 10 | 25 | 55 | |
| Transition Time: Low-to-High, t_{TLH} | 5 | 5 | 50 | 100 | ns |
| | 10 | 10 | 30 | 60 | |
| | 5 | 5 | 20 | 45 | |
| | 10 | 10 | 16 | 40 | |
| Input Capacitance, C_i | CD4049A | — | 15 | — | pF |
| | CD4050A | — | 5 | — | |

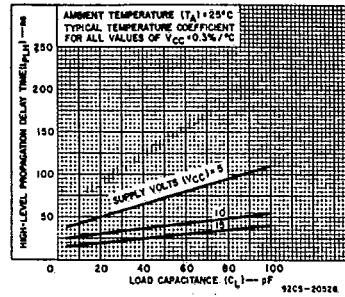

Fig. 12—Typical low-to-high level propagation delay time vs. C_L for CD4049A.

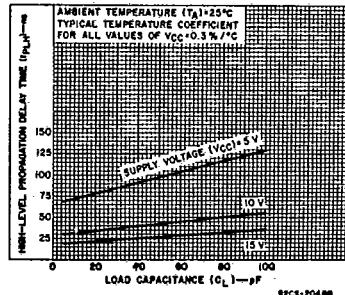

Fig. 13—Typical low-to-high level propagation delay time vs. C_L for CD4050A.

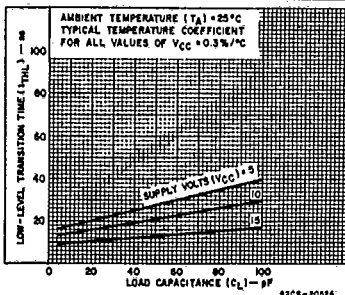

Fig. 14—Typical high-to-low level transition time vs. C_L for CD4049A, CD4050A.

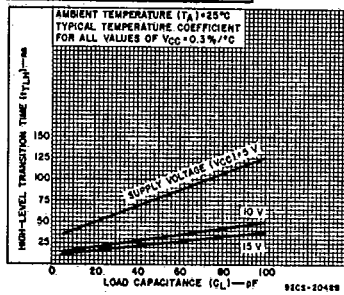

Fig. 15—Typical low-to-high level transition time vs. C_L for CD4049A, CD4050A.

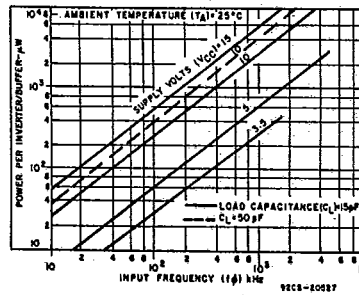

Fig. 16—Typical dissipation characteristics for CD4049A, CD4050A.

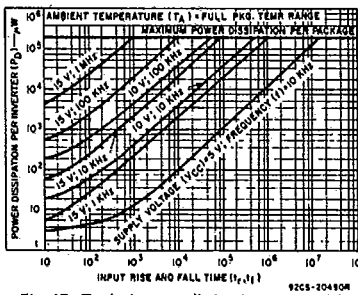

Fig. 17—Typical power dissipation vs. transition time per inverter CD4049A.

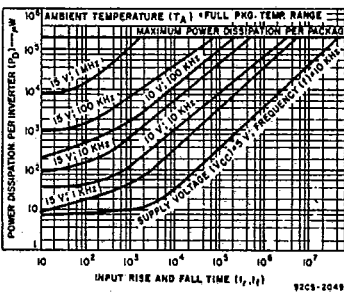

Fig. 18—Typical power dissipation vs. transition time per inverter CD4050A.

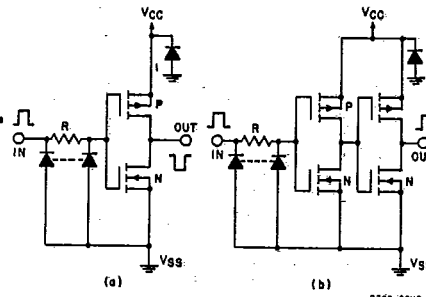

Fig. 22 — (a) Schematic diagram of CD4049A, 1 of 6 identical units.
(b) Schematic diagram of CD4050A, 1 of 6 identical units.

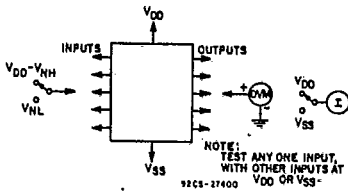

Fig. 19—Noise immunity test circuit.

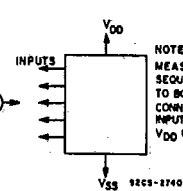

Fig. 20—Input leakage current test circuit.

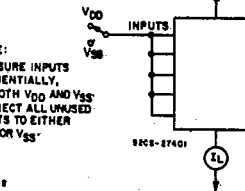
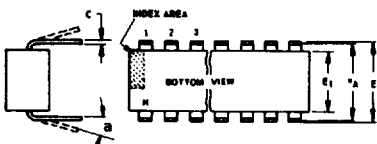
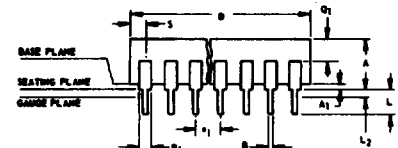

Fig. 21—Quiescent device current test circuit.

Dimensional Outlines

Dual-In-Line Welded-Seal Ceramic Packages



- NOTES:**
Refer to Rules for Dimensioning (JEDEC Publication No. 95) for Axial Lead Product Outlines.
- When this device is supplied solder-dipped, the maximum lead thickness (narrow portion) will not exceed 0.013" (0.33 mm).
 - Leads within 0.005" (0.12 mm) radius of True Position (TP) at gauge plane with maximum material condition and unit installed.
 - e_A applies in zone L₂ when unit installed.
 - a applies to spread leads prior to installation.
 - N is the maximum quantity of lead positions.
 - N₁ is the quantity of allowable missing leads.

(D) SUFFIX (JEDEC MO-001-AD)
14-Lead Dual-In-Line Welded-Seal
Ceramic Package

| SYMBOL | INCHES | | NOTE | MILLIMETERS | |
|----------------|----------|-------|------|-------------|-------|
| | MIN. | MAX. | | MIN. | MAX. |
| A | 0.120 | 0.160 | | 3.05 | 4.06 |
| A ₁ | 0.020 | 0.065 | | 0.51 | 1.65 |
| B | 0.014 | 0.020 | | 0.356 | 0.508 |
| B ₁ | 0.060 | 0.065 | | 1.27 | 1.65 |
| C | 0.008 | 0.012 | 1 | 0.204 | 0.304 |
| D | 0.745 | 0.770 | | 18.93 | 19.55 |
| E | 0.300 | 0.325 | | 7.62 | 8.25 |
| E ₁ | 0.240 | 0.260 | | 6.10 | 6.60 |
| e ₁ | 0.100 TP | | 2 | 2.54 TP | |
| e _A | 0.300 TP | | 2, 3 | 7.62 TP | |
| L | 0.125 | 0.150 | | 3.18 | 3.81 |
| L ₂ | 0.000 | 0.030 | | 0.000 | 0.76 |
| a | 0° | 15° | 4 | 0° | 15° |
| N | 14 | | 5 | 14 | |
| N ₁ | 0 | | 6 | 0 | |
| Q ₁ | 0.050 | 0.085 | | 1.27 | 2.15 |
| S | 0.065 | 0.090 | | 1.66 | 2.28 |

92SS-4411R2

(D) SUFFIX (JEDEC MO-001-AE)
16-Lead Dual-In-Line Welded-Seal
Ceramic Package

| SYMBOL | INCHES | | NOTE | MILLIMETERS | |
|----------------|----------|-------|------|-------------|-------|
| | MIN. | MAX. | | MIN. | MAX. |
| A | 0.120 | 0.160 | | 3.05 | 4.06 |
| A ₁ | 0.020 | 0.065 | | 0.51 | 1.65 |
| B | 0.014 | 0.020 | | 0.356 | 0.508 |
| B ₁ | 0.035 | 0.065 | | 0.89 | 1.65 |
| C | 0.008 | 0.012 | 1 | 0.204 | 0.304 |
| D | 0.745 | 0.785 | | 18.93 | 19.93 |
| E | 0.300 | 0.325 | | 7.62 | 8.25 |
| E ₁ | 0.240 | 0.260 | | 6.10 | 6.60 |
| e ₁ | 0.100 TP | | 2 | 2.54 TP | |
| e _A | 0.300 TP | | 2, 3 | 7.62 TP | |
| L | 0.125 | 0.150 | | 3.18 | 3.81 |
| L ₂ | 0.000 | 0.030 | | 0.000 | 0.76 |
| a | 0° | 15° | 4 | 0° | 15° |
| N | 16 | | 5 | 16 | |
| N ₁ | 0 | | 6 | 0 | |
| Q ₁ | 0.050 | 0.085 | | 1.27 | 2.15 |
| S | 0.015 | 0.060 | | 0.39 | 1.52 |

92SS-4266R5

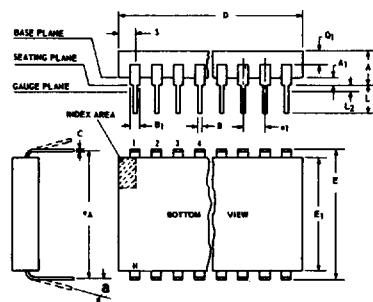

- NOTES:**
Refer to Rules for Dimensioning (JEDEC Publication No. 95) for Axial Lead Product Outlines.
- When this device is supplied solder-dipped, the maximum lead thickness (narrow portion) will not exceed 0.013" (0.33 mm).
 - Leads within 0.005" (0.12 mm) radius of True Position (TP) at gauge plane with maximum material condition and unit installed.
 - e_A applies in zone L₂ when unit installed.
 - a applies to spread leads prior to installation.
 - N is the maximum quantity of lead positions.
 - N₁ is the quantity of allowable missing leads.

(D) SUFFIX (JEDEC MO-015-AG)
24-Lead Dual-In-Line Welded-Seal
Ceramic Package

| SYMBOL | INCHES | | NOTE | MILLIMETERS | |
|----------------|----------|-------|------|-------------|-------|
| | MIN. | MAX. | | MIN. | MAX. |
| A | 0.090 | 0.200 | | 2.29 | 5.08 |
| A ₁ | 0.020 | 0.070 | | 0.51 | 1.78 |
| B | 0.015 | 0.020 | | 0.381 | 0.508 |
| B ₁ | 0.045 | 0.055 | | 1.143 | 1.397 |
| C | 0.008 | 0.012 | 1 | 0.204 | 0.304 |
| D | 1.15 | 1.22 | | 29.21 | 30.98 |
| E | 0.600 | 0.625 | | 15.24 | 15.87 |
| E ₁ | 0.480 | 0.520 | | 12.20 | 13.20 |
| e ₁ | 0.100 TP | | 2 | 2.54 TP | |
| e _A | 0.600 TP | | 2, 3 | 15.24 TP | |
| L | 0.100 | 0.180 | | 2.54 | 4.57 |
| L ₂ | 0.000 | 0.030 | | 0.00 | 0.76 |
| a | 0° | 15° | 4 | 0° | 15° |
| N | 24 | | 5 | 24 | |
| N ₁ | 0 | | 6 | 0 | |
| Q ₁ | 0.020 | 0.080 | | 0.51 | 2.03 |
| S | 0.020 | 0.060 | | 0.51 | 1.52 |

92CS-19948R4

(D) SUFFIX (JEDEC MO-015-AH)
28-Lead Dual-In-Line Welded-Seal
Ceramic Package

| SYMBOL | INCHES | | NOTE | MILLIMETERS | |
|----------------|----------|-------|------|-------------|-------|
| | MIN. | MAX. | | MIN. | MAX. |
| A | 0.090 | 0.200 | | 2.29 | 5 |
| A ₁ | 0 | 0.070 | 2 | 0 | 1.77 |
| B | 0.015 | 0.020 | | 0.381 | 0.508 |
| B ₁ | 0.015 | 0.065 | | 0.39 | 1.39 |
| C | 0.008 | 0.012 | 1 | 0.204 | 0.304 |
| D | 1.380 | 1.420 | | 35.06 | 36.06 |
| E | 0.600 | 0.625 | | 15.24 | 15.87 |
| E ₁ | 0.485 | 0.515 | | 12.32 | 13.08 |
| e ₁ | 0.100 TP | | 2 | 2.54 TP | |
| e _A | 0.600 TP | | 2, 3 | 15.24 TP | |
| L | 0.100 | 0.200 | | 2.6 | 5 |
| L ₂ | 0 | 0.030 | | 0 | 0.76 |
| a | 0° | 15° | 4 | 0° | 15° |
| N | 28 | | 5 | 28 | |
| N ₁ | 0 | | 6 | 0 | |
| Q ₁ | 0.020 | 0.070 | | 0.51 | 1.77 |
| S | 0.040 | 0.070 | | 1.02 | 1.77 |

92CM-20250R2

TO-5 Style Package

(T) SUFFIX (JEDEC MO-006-AG)
12-Lead Metal Package

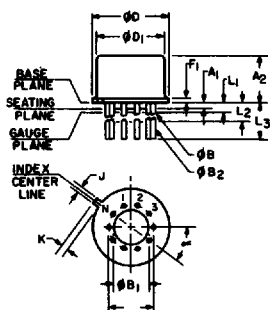

92CS-19774

| SYMBOL | INCHES | | NOTE | MILLIMETERS | |
|-----------------|--------|-------|------|-------------|-------|
| | MIN. | MAX. | | MIN. | MAX. |
| a | 0.230 | | 2 | 5.84 TP | |
| A ₁ | 0 | 0 | | 0 | 0 |
| A ₂ | 0.165 | 0.185 | | 4.19 | 4.70 |
| φB | 0.016 | 0.019 | 3 | 0.407 | 0.482 |
| φB ₁ | 0 | 0 | | 0 | 0 |
| φB ₂ | 0.016 | 0.021 | 3 | 0.407 | 0.533 |
| φD | 0.335 | 0.370 | | 8.51 | 9.39 |
| φD ₁ | 0.305 | 0.335 | | 7.75 | 8.50 |
| F ₁ | 0.020 | 0.040 | | 0.51 | 1.01 |
| j | 0.028 | 0.034 | | 0.712 | 0.863 |
| k | 0.029 | 0.045 | 4 | 0.74 | 1.14 |
| L ₁ | 0.000 | 0.050 | 3 | 0.00 | 1.27 |
| L ₂ | 0.250 | 0.500 | 3 | 6.4 | 12.7 |
| L ₃ | 0.500 | 0.562 | 3 | 12.7 | 14.27 |
| a | 30° TP | | | 30° TP | |
| N | 12 | | 6 | 12 | |
| N ₁ | 1 | | 5 | 1 | |

NOTES:

- Refer to Rules for Dimensioning Axial Lead Product Outlines.
- Leads at gauge plane within 0.007" (0.178 mm) radius of True Position (TP) at maximum material condition.
- φB applies between L₁ and L₂. φB₂ applies between L₂ and 0.500" (12.70 mm) from seating plane. Diameter is uncontrolled in L₁ and beyond 0.500" (12.70 mm).
- Measure from Max. φD.
- N₁ is the quantity of allowable missing leads.
- N is the maximum quantity of lead positions.

Dimensional Outlines (Cont'd)

DUAL-IN-LINE SIDE-BRAZED CERAMIC PACKAGES

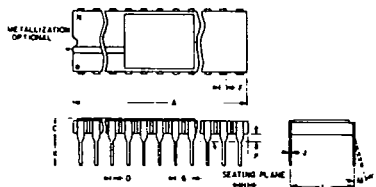

(D) SUFFIX
18-Lead Dual-In-Line
Side-Brazed Ceramic Package

| SYMBOL | INCHES | | NOTE | MILLIMETERS | |
|--------|--------|-------|------|-------------|--------|
| | MIN. | MAX. | | MIN. | MAX. |
| A | 0.890 | 0.915 | | 22.606 | 23.241 |
| C | — | 0.200 | | — | 5.080 |
| D | 0.015 | 0.021 | | 0.381 | 0.533 |
| F | 0.054 | REF. | 1 | 1.371 | REF. |
| G | 0.100 | BSC | 1 | 2.54 | BSC |
| H | 0.035 | 0.065 | | 0.889 | 1.651 |
| J | 0.008 | 0.012 | 3 | 0.203 | 0.304 |
| K | 0.125 | 0.150 | | 3.175 | 3.810 |
| L | 0.290 | 0.310 | 2 | 7.366 | 7.874 |
| M | — | 15° | | 0° | 15° |
| P | 0.025 | 0.045 | | 0.635 | 1.143 |
| N | 18 | | | 18 | |

92CS-27231R1

(D) SUFFIX
22-Lead Dual-In-Line
Side-Brazed Ceramic Package

| SYMBOL | INCHES | | NOTE | MILLIMETERS | |
|--------|--------|-------|------|-------------|-------|
| | MIN. | MAX. | | MIN. | MAX. |
| A | 1.065 | 1.100 | | 27.05 | 27.94 |
| C | 0.085 | 0.145 | | 2.16 | 3.68 |
| D | 0.017 | 0.023 | | 0.43 | 0.58 |
| F | 0.040 | REF. | 1 | 1.02 | REF. |
| G | 0.100 | BSC | 1 | 2.54 | BSC |
| H | 0.030 | 0.070 | | 0.76 | 1.78 |
| J | 0.008 | 0.012 | 3 | 0.20 | 0.30 |
| K | 0.125 | 0.175 | | 3.18 | 4.45 |
| L | 0.380 | 0.420 | 2 | 9.65 | 10.67 |
| M | — | 7° | | — | 7° |
| P | 0.025 | 0.050 | | 0.64 | 1.27 |
| N | 22 | | | 22 | |

92CS-25186R2

NOTES:

- Leads within 0.005" (0.13 mm)-radius of True Position at maximum material condition.
- Dimension "L" to center of leads when formed parallel.
- When this device is supplied solder-dipped, the maximum lead thickness (narrow portion) will not exceed 0.013" (0.33 mm).

(D) SUFFIX
24-Lead Dual-In-Line
Side-Brazed Ceramic Package

| SYMBOL | INCHES | | NOTE | MILLIMETERS | |
|--------|--------|-------|------|-------------|-------|
| | MIN. | MAX. | | MIN. | MAX. |
| A | 1.180 | 1.220 | | 29.98 | 30.98 |
| C | 0.085 | 0.145 | | 2.16 | 3.68 |
| D | 0.015 | 0.023 | | 0.39 | 0.58 |
| F | 0.040 | REF. | | 1.02 | REF. |
| G | 0.100 | BSC | 1 | 2.54 | BSC |
| H | 0.030 | 0.070 | | 0.77 | 1.77 |
| J | 0.008 | 0.012 | 3 | 0.21 | 0.30 |
| K | 0.125 | 0.175 | | 3.18 | 4.44 |
| L | 0.580 | 0.620 | 2 | 14.74 | 15.74 |
| M | — | 7° | | — | 7° |
| P | 0.025 | 0.050 | | 0.64 | 1.27 |
| N | 24 | | | 24 | |

92CS-30968R1

(D) SUFFIX
40-Lead Dual-In-Line
Side-Brazed Ceramic Package

| SYMBOL | INCHES | | NOTE | MILLIMETERS | |
|--------|--------|-------|------|-------------|-------|
| | MIN. | MAX. | | MIN. | MAX. |
| A | 1.980 | 2.020 | | 50.30 | 51.30 |
| C | 0.095 | 0.155 | | 2.43 | 3.93 |
| D | 0.017 | 0.023 | | 0.43 | 0.58 |
| F | 0.050 | REF. | | 1.27 | REF. |
| G | 0.100 | BSC | 1 | 2.54 | BSC |
| H | 0.030 | 0.070 | | 0.76 | 1.78 |
| J | 0.008 | 0.012 | 3 | 0.20 | 0.30 |
| K | 0.125 | 0.175 | | 3.18 | 4.45 |
| L | 0.580 | 0.620 | 2 | 14.74 | 15.74 |
| M | — | 7° | | — | 7° |
| P | 0.025 | 0.050 | | 0.64 | 1.27 |
| N | 40 | | | 40 | |

92CM-27029R2

Dual-In-Line Plastic and Frit-Seal Ceramic Packages

(E) SUFFIX (JEDEC MO-001-AN)
8-Lead Dual-In-Line Plastic
(Mini-DIP) Package

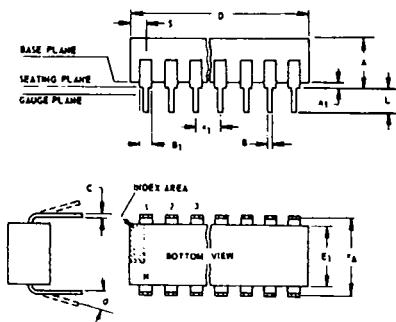

| SYMBOL | INCHES | | NOTE | MILLIMETERS | |
|----------------|--------|-------|------|-------------|-------|
| | MIN. | MAX. | | MIN. | MAX. |
| A | 0.155 | 0.200 | | 3.94 | 5.08 |
| A ₁ | 0.020 | 0.050 | | 0.508 | 1.27 |
| B | 0.014 | 0.020 | | 0.356 | 0.508 |
| B ₁ | 0.035 | 0.065 | | 0.889 | 1.65 |
| C | 0.008 | 0.012 | 1 | 0.203 | 0.304 |
| D | 0.370 | 0.400 | | 9.40 | 10.16 |
| E | 0.300 | 0.325 | | 7.62 | 8.25 |
| E ₁ | 0.240 | 0.260 | | 6.10 | 6.60 |
| e ₁ | 0.100 | TP | 2 | 2.54 | TP |
| e _A | 0.300 | TP | 2, 3 | 7.62 | TP |
| L | 0.125 | 0.150 | | 3.18 | 3.81 |
| L ₂ | 0.000 | 0.030 | | 0.000 | 0.762 |
| a | 0 | 15 | 4 | 0 | 15 |
| N | 8 | | 5 | 8 | |
| N ₁ | 0 | | 6 | 0 | |
| O ₁ | 0.040 | 0.075 | | 1.02 | 1.90 |
| S | 0.015 | 0.060 | | 0.381 | 1.52 |

92CS-24026 R1

NOTES:

Refer to Rules for Dimensioning (JEDEC Publication No. 95) for Axial Lead Product Outlines.

- When this device is supplied solder-dipped, the maximum lead thickness (narrow portion) will not exceed 0.013".
- Leads within 0.005" (0.12 mm) radius of True Position (TP) at gauge plane with maximum material condition and unit installed.
- e_A applies in zone L₂ when unit installed.
- a applies to spread leads prior to installation.
- N is the maximum quantity of lead positions.
- N₁ is the quantity of allowable missing leads.

Dimensional Outlines (Cont'd)

Dual-In-Line Plastic and Frit-Seal Ceramic Packages (Cont'd)

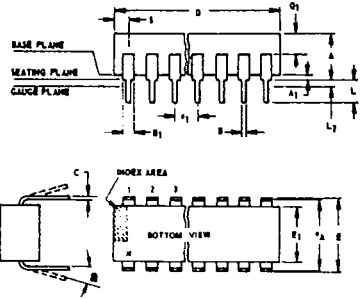

NOTES:
 Refer to Rules for Dimensioning (JEDEC Publication No. 95) for Axial Lead Product Outlines.
 1. When this device is supplied solder dipped, the maximum lead thickness (narrow portion) will not exceed 0.013" (0.33 mm).
 2. Leads within 0.005" (0.12 mm) radius of True Position (TP) at gauge plane with maximum material condition and unit installed.
 3. eA applies in zone L2 when unit installed.
 4. alpha applies to spread leads prior to installation.
 5. N is the maximum quantity of lead positions.
 6. N1 is the quantity of allowable missing leads.

(E) and (F) SUFFIXES (JEDEC MO-001-AB)
 14-Lead Dual-In-Line Plastic or Frit-Seal Ceramic Package

| SYMBOL | INCHES | | NOTE | MILLIMETERS | |
|--------|----------|-------|------|-------------|-------|
| | MIN. | MAX. | | MIN. | MAX. |
| A | 0.155 | 0.200 | | 3.94 | 5.08 |
| A1 | 0.020 | 0.050 | | 0.51 | 1.27 |
| B | 0.014 | 0.020 | | 0.356 | 0.508 |
| B1 | 0.050 | 0.065 | | 1.27 | 1.65 |
| C | 0.008 | 0.012 | 1 | 0.204 | 0.304 |
| D | 0.745 | 0.770 | | 18.93 | 19.55 |
| E | 0.300 | 0.325 | | 7.62 | 8.25 |
| E1 | 0.240 | 0.260 | | 6.10 | 6.60 |
| e1 | 0.100 TP | | 2 | 2.54 TP | |
| eA | 0.300 TP | | 2,3 | 7.62 TP | |
| L | 0.125 | 0.150 | | 3.18 | 3.81 |
| L2 | 0.000 | 0.030 | | 0.000 | 0.76 |
| a | 0° | 15° | 4 | 0° | 15° |
| N | 14 | | 5 | 14 | |
| N1 | 0 | | 6 | 0 | |
| Q1 | 0.040 | 0.075 | | 1.02 | 1.90 |
| S | 0.065 | 0.090 | | 1.66 | 2.28 |

92SS-4296R3

(E) and (F) SUFFIXES (JEDEC MO-001-AC)
 16-Lead Dual-In-Line Plastic or Frit-Seal Ceramic Package

| SYMBOL | INCHES | | NOTE | MILLIMETERS | |
|--------|----------|-------|------|-------------|-------|
| | MIN. | MAX. | | MIN. | MAX. |
| A | 0.155 | 0.200 | | 3.94 | 5.08 |
| A1 | 0.020 | 0.050 | | 0.51 | 1.27 |
| B | 0.014 | 0.020 | | 0.356 | 0.508 |
| B1 | 0.035 | 0.065 | | 0.89 | 1.65 |
| C | 0.008 | 0.012 | 1 | 0.204 | 0.304 |
| D | 0.745 | 0.785 | | 18.93 | 19.93 |
| E | 0.300 | 0.325 | | 7.62 | 8.25 |
| E1 | 0.240 | 0.260 | | 6.10 | 6.60 |
| e1 | 0.100 TP | | 2 | 2.54 TP | |
| eA | 0.300 TP | | 2,3 | 7.62 TP | |
| L | 0.125 | 0.150 | | 3.18 | 3.81 |
| L2 | 0.000 | 0.030 | | 0.000 | 0.76 |
| a | 0° | 15° | 4 | 0° | 15° |
| N | 16 | | 5 | 16 | |
| N1 | 0 | | 6 | 0 | |
| Q1 | 0.040 | 0.075 | | 1.02 | 1.90 |
| S | 0.015 | 0.060 | | 0.39 | 1.52 |

92CM-15967R4

(E) SUFFIX
 18-Lead Dual-In-Line Plastic Package

| SYMBOL | INCHES | | NOTE | MILLIMETERS | |
|--------|----------|-------|------|-------------|-------|
| | MIN. | MAX. | | MIN. | MAX. |
| A | 0.155 | 0.200 | | 3.94 | 5.08 |
| A1 | 0.020 | 0.050 | | 0.508 | 1.27 |
| B | 0.014 | 0.020 | | 0.356 | 0.508 |
| B1 | 0.035 | 0.065 | | 0.89 | 1.65 |
| C | 0.008 | 0.012 | 1 | 0.204 | 0.304 |
| D | 0.845 | 0.885 | | 21.47 | 22.47 |
| E1 | 0.240 | 0.260 | | 6.10 | 6.60 |
| e1 | 0.100 TP | | 2 | 2.54 TP | |
| eA | 0.300 TP | | 2,3 | 7.62 TP | |
| L | 0.125 | 0.150 | | 3.18 | 3.81 |
| a | 0° | 15° | 4 | 0° | 15° |
| N | 18 | | 5 | 18 | |
| N1 | 0 | | 6 | 0 | |
| S | 0.015 | 0.060 | | 0.39 | 1.52 |

92CS-30630

(E) SUFFIX
 22-Lead Dual-In-Line Plastic Package

| SYMBOL | INCHES | | NOTE | MILLIMETERS | |
|--------|----------|-------|------|-------------|-------|
| | MIN. | MAX. | | MIN. | MAX. |
| A | 0.155 | 0.200 | | 3.94 | 5.08 |
| A1 | 0.020 | 0.050 | | 0.508 | 1.27 |
| B | 0.015 | 0.020 | | 0.381 | 0.508 |
| B1 | 0.035 | 0.065 | | 0.89 | 1.65 |
| C | 0.008 | 0.012 | 1 | 0.204 | 0.304 |
| D | | 1.120 | | | 28.44 |
| E | 0.390 | 0.420 | | 9.91 | 10.66 |
| E1 | 0.345 | 0.355 | | 8.77 | 9.01 |
| e1 | 0.100 TP | | 2 | 2.54 TP | |
| eA | 0.400 TP | | 2,3 | 10.16 TP | |
| L | 0.125 | 0.150 | | 3.18 | 3.81 |
| L2 | 0 | 0.030 | | 0 | 0.762 |
| a | 2° | 15° | 4 | 2° | 15° |
| N | 22 | | 5 | 22 | |
| N1 | 0 | | 6 | 0 | |
| Q1 | 0.055 | 0.085 | | 1.40 | 2.15 |
| S | 0.015 | 0.060 | | 0.381 | 1.27 |

92CS-30830

(F) SUFFIX (JEDEC MO-001-AG)
 16-Lead Dual-In-Line Frit-Seal Ceramic Package

| SYMBOL | INCHES | | NOTE | MILLIMETERS | |
|--------|----------|-------|------|-------------|-------|
| | MIN. | MAX. | | MIN. | MAX. |
| A | 0.165 | 0.210 | | 4.20 | 5.33 |
| A1 | 0.015 | 0.045 | | 0.381 | 1.14 |
| B | 0.015 | 0.020 | | 0.381 | 0.508 |
| B1 | 0.045 | 0.070 | | 1.15 | 1.77 |
| C | 0.009 | 0.011 | 1 | 0.229 | 0.279 |
| D | 0.750 | 0.795 | | 19.05 | 20.19 |
| E | 0.295 | 0.325 | | 7.50 | 8.25 |
| E1 | 0.245 | 0.300 | | 6.23 | 7.62 |
| e1 | 0.100 TP | | 2 | 2.54 TP | |
| eA | 0.300 TP | | 2,3 | 7.62 TP | |
| L | 0.120 | 0.160 | | 3.05 | 4.06 |
| L2 | 0.000 | 0.030 | | 0.000 | 0.76 |
| a | 2° | 15° | 4 | 2° | 15° |
| N | 16 | | 5 | 16 | |
| N1 | 0 | | 6 | 0 | |
| Q1 | 0.050 | 0.080 | | 1.27 | 2.03 |
| S | 0.010 | 0.060 | | 0.254 | 1.52 |

92CM-22284R1

(E) and (F) SUFFIXES (JEDEC MO-015-AA)
 24-Lead Dual-In-Line Plastic or Frit-Seal Ceramic Package

| SYMBOL | INCHES | | NOTE | MILLIMETERS | |
|--------|----------|-------|------|-------------|-------|
| | MIN. | MAX. | | MIN. | MAX. |
| A | 0.120 | 0.250 | | 3.10 | 6.30 |
| A1 | 0.020 | 0.070 | | 0.51 | 1.77 |
| B | 0.016 | 0.020 | | 0.407 | 0.508 |
| B1 | 0.028 | 0.070 | | 0.72 | 1.77 |
| C | 0.008 | 0.012 | 1 | 0.204 | 0.304 |
| D | 1.20 | 1.29 | | 30.48 | 32.76 |
| E | 0.600 | 0.625 | | 15.24 | 15.87 |
| E1 | 0.515 | 0.580 | | 13.09 | 14.73 |
| e1 | 0.100 TP | | 2 | 2.54 TP | |
| eA | 0.600 TP | | 2,3 | 15.24 TP | |
| L | 0.100 | 0.200 | | 2.54 | 5.00 |
| L2 | 0.000 | 0.030 | | 0.00 | 0.76 |
| a | 0° | 15° | 4 | 0° | 15° |
| N | 24 | | 5 | 24 | |
| N1 | 0 | | 6 | 0 | |
| Q1 | 0.040 | 0.075 | | 1.02 | 1.90 |
| S | 0.040 | 0.100 | | 1.02 | 2.54 |

92CS26938R2

(E) SUFFIX
 40-Lead Dual-In-Line Plastic Package

| SYMBOL | INCHES | | NOTE | MILLIMETERS | |
|--------|----------|-------|------|-------------|-------|
| | MIN. | MAX. | | MIN. | MAX. |
| A | 0.120 | 0.250 | | 3.10 | 6.30 |
| A1 | 0.020 | 0.070 | | 0.51 | 1.77 |
| B | 0.016 | 0.020 | | 0.407 | 0.508 |
| B1 | 0.028 | 0.070 | | 0.72 | 1.77 |
| C | 0.008 | 0.012 | 1 | 0.204 | 0.304 |
| D | 2.000 | 2.090 | | 50.80 | 53.09 |
| E1 | 0.515 | 0.580 | | 13.09 | 14.73 |
| e1 | 0.100 TP | | 2 | 2.54 TP | |
| eA | 0.600 TP | | 2,3 | 15.24 TP | |
| L | 0.100 | 0.200 | | 2.54 | 5.00 |
| L2 | 0.000 | 0.030 | | 0.00 | 0.76 |
| a | 0° | 15° | 4 | 0° | 15° |
| N | 40 | | 5 | 40 | |
| N1 | 0 | | 6 | 0 | |
| Q1 | 0.065 | 0.095 | | 1.66 | 2.41 |
| S | 0.040 | 0.100 | | 1.02 | 2.54 |

92CS-30959

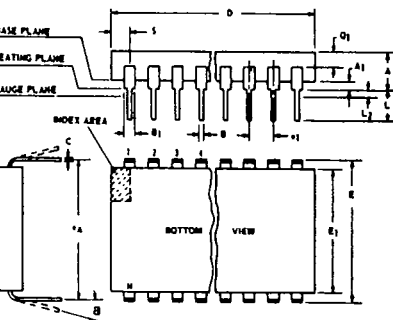

NOTES:
 Refer to Rules for Dimensioning (JEDEC Publication No. 95) for Axial Lead Product Outlines.
 1. When this device is supplied solder dipped, the maximum lead thickness (narrow portion) will not exceed 0.013".
 2. Leads within 0.005" (0.12 mm) radius of True Position (TP) at gauge plane with maximum material condition and unit installed.
 3. eA applies in zone L2 when unit installed.
 4. alpha applies to spread leads prior to installation.
 5. N is the maximum quantity of lead positions.
 6. N1 is the quantity of allowable missing leads.

T-90-20

Dimensional Outlines (Cont'd)

Ceramic Flat Packs

(K) SUFFIX (JEDEC MO-004-AF)
14-Lead

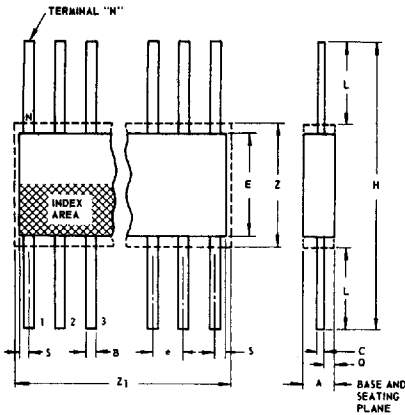

| SYMBOL | INCHES | | NOTE | MILLIMETERS | |
|----------------|----------|-------|------|-------------|-------|
| | MIN. | MAX. | | MIN. | MAX. |
| A | 0.008 | 0.100 | | 0.21 | 2.54 |
| B | 0.015 | 0.019 | 1 | 0.381 | 0.482 |
| C | 0.003 | 0.006 | 1 | 0.077 | 0.152 |
| e | 0.050 TP | | 2 | 1.27 TP | |
| E | 0.200 | 0.300 | | 5.1 | 7.6 |
| H | 0.600 | 1.000 | | 15.3 | 25.4 |
| L | 0.150 | 0.350 | | 3.9 | 8.8 |
| N | 14 | | 3 | 14 | |
| Q | 0.005 | 0.050 | | 0.13 | 1.27 |
| S | 0.000 | 0.050 | | 0.00 | 1.27 |
| Z | 0.300 | | 4 | 7.62 | |
| Z ₁ | 0.400 | | 4 | 10.16 | |

92SS-4300R3

NOTES:

1. Refer to JEDEC Publication No. 95 for Rules for Dimensioning Peripheral Lead Outlines.
2. Leads within 0.005" (0.12 mm) radius of True Position (TP) at maximum material condition.
3. N is the maximum quantity of lead positions.
4. Z and Z₁ determine a zone within which all body and lead irregularities lie.

(K) SUFFIX (JEDEC MO-004-AG)
16-Lead

| SYMBOL | INCHES | | NOTE | MILLIMETERS | |
|----------------|----------|-------|------|-------------|-------|
| | MIN. | MAX. | | MIN. | MAX. |
| A | 0.008 | 0.100 | | 0.21 | 2.54 |
| B | 0.015 | 0.019 | 1 | 0.381 | 0.482 |
| C | 0.003 | 0.006 | 1 | 0.077 | 0.152 |
| e | 0.050 TP | | 2 | 1.27 TP | |
| E | 0.200 | 0.300 | | 5.1 | 7.6 |
| H | 0.600 | 1.000 | | 15.3 | 25.4 |
| L | 0.150 | 0.350 | | 3.9 | 8.8 |
| N | 16 | | 3 | 16 | |
| Q | 0.005 | 0.050 | | 0.13 | 1.27 |
| S | 0.000 | 0.025 | | 0.00 | 0.63 |
| Z | 0.300 | | 4 | 7.62 | |
| Z ₁ | 0.400 | | 4 | 10.16 | |

92CS-17271R3

(K) SUFFIX
24-Lead

| SYMBOL | INCHES | | NOTE | MILLIMETERS | |
|----------------|----------|-------|------|-------------|-------|
| | MIN. | MAX. | | MIN. | MAX. |
| A | 0.075 | 0.120 | | 1.91 | 3.04 |
| B | 0.018 | 0.022 | 1 | 0.458 | 0.558 |
| C | 0.004 | 0.007 | 1 | 0.102 | 0.177 |
| e | 0.050 TP | | 2 | 1.27 TP | |
| E | 0.600 | 0.700 | | 15.24 | 17.78 |
| H | 1.150 | 1.350 | | 29.21 | 34.29 |
| L | 0.225 | 0.325 | | 5.72 | 8.25 |
| N | 24 | | 3 | 24 | |
| Q | 0.035 | 0.070 | | 0.89 | 1.77 |
| S | 0.060 | 0.110 | 1 | 1.53 | 2.79 |
| Z | 0.700 | | 4 | 17.78 | |
| Z ₁ | 0.750 | | 4 | 19.05 | |

92CS-19949R2

(K) SUFFIX
28-Lead

| SYMBOL | INCHES | | NOTE | MILLIMETERS | |
|----------------|----------|-------|------|-------------|-------|
| | MIN. | MAX. | | MIN. | MAX. |
| A | 0.075 | 0.120 | | 1.91 | 3.04 |
| B | 0.018 | 0.022 | 1 | 0.458 | 0.558 |
| C | 0.004 | 0.007 | 1 | 0.102 | 0.177 |
| e | 0.050 TP | | 2 | 1.27 TP | |
| E | 0.600 | 0.700 | | 15.24 | 17.78 |
| H | 1.150 | 1.350 | | 29.21 | 34.29 |
| L | 0.225 | 0.325 | | 5.72 | 8.25 |
| N | 28 | | 3 | 28 | |
| Q | 0.035 | 0.070 | | 0.89 | 1.77 |
| S | 0 | 0.060 | 1 | 0 | 1.53 |
| Z | 0.700 | | 4 | 17.78 | |
| Z ₁ | 0.750 | | 4 | 19.05 | |

92CS-20972