

IRF7322D1

FETKY™ MOSFET / Schottky Diode

- Co-packaged HEXFET® Power MOSFET and Schottky Diode
- Ideal For Buck Regulator Applications
- P-Channel HEXFET
- Low V_F Schottky Rectifier
- Generation 5 Technology
- SO-8 Footprint

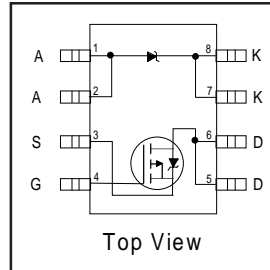

$V_{DSS} = -20V$
$R_{DS(on)} = 0.058\Omega$
Schottky $V_f = 0.39V$

Description

The **FETKY** family of co-packaged MOSFETs and Schottky diodes offers the designer an innovative, board space saving solution for switching regulator and power management applications. Generation 5 HEXFET Power MOSFETs utilize advanced processing techniques to achieve extremely low on-resistance per silicon area. Combining this technology with International Rectifier's low forward drop Schottky rectifiers results in an extremely efficient device suitable for use in a wide variety of portable electronics applications.

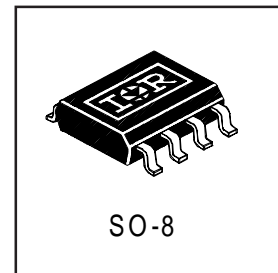

The SO-8 has been modified through a customized leadframe for enhanced thermal characteristics. The SO-8 package is designed for vapor phase, infrared or wave soldering techniques.

Absolute Maximum Ratings ($T_A = 25^\circ C$ unless otherwise noted)

Parameter		Maximum	Units
$I_D @ T_A = 25^\circ C$	Continuous Drain Current, $V_{GS} @ -4.5V$	-5.3	A
$I_D @ T_A = 70^\circ C$		-4.3	
I_{DM}		Pulsed Drain Current ①	
$P_D @ T_A = 25^\circ C$	Power Dissipation	2.0	W
$P_D @ T_A = 70^\circ C$		1.3	
	Linear Derating Factor	16	mW/°C
V_{GS}	Gate-to-Source Voltage	± 12	V
dv/dt	Peak Diode Recovery dv/dt ②	-5.0	V/ns
T_J, T_{STG}	Junction and Storage Temperature Range	-55 to +150	°C

Thermal Resistance Ratings

Parameter		Maximum	Units
$R_{\theta JA}$	Junction-to-Ambient ④	62.5	°C/W

Notes:

- ① Repetitive rating; pulse width limited by maximum junction temperature (see figure 9)
- ② $I_{SD} \leq -2.9A$, $di/dt \leq -77A/\mu s$, $V_{DD} \leq V_{(BR)DSS}$, $T_J \leq 150^\circ C$
- ③ Pulse width $\leq 300\mu s$; duty cycle $\leq 2\%$
- ④ Surface mounted on FR-4 board, $t \leq 10sec$.

MOSFET Electrical Characteristics @ T_J = 25°C (unless otherwise specified)

Parameter		Min.	Typ.	Max.	Units	Conditions
V _{(BR)DSS}	Drain-to-Source Breakdown Voltage	-20	—	—	V	V _{GS} = 0V, I _D = -250μA
R _{DS(on)}	Static Drain-to-Source On-Resistance	—	0.049	0.062	Ω	V _{GS} = -4.5V, I _D = -2.9A ③
		—	0.082	0.098		V _{GS} = -2.7V, I _D = -1.5A ③
V _{GS(th)}	Gate Threshold Voltage	-0.70	—	—	V	V _{DS} = V _{GS} , I _D = -250μA
g _{fs}	Forward Transconductance	—	5.9	—	S	V _{DS} = -10V, I _D = -1.5A
I _{DSS}	Drain-to-Source Leakage Current	—	—	-1.0	μA	V _{DS} = -16V, V _{GS} = 0V
		—	—	-25		V _{DS} = -16V, V _{GS} = 0V, T _J = 55°C
I _{GSS}	Gate-to-Source Forward Leakage	—	—	100	nA	V _{GS} = -12.0V
	Gate-to-Source Reverse Leakage	—	—	-100		V _{GS} = 12.0V
Q _g	Total Gate Charge	—	19	29	nC	I _D = -2.9A
Q _{gs}	Gate-to-Source Charge	—	4.0	6.1		V _{DS} = -16V
Q _{gd}	Gate-to-Drain ("Miller") Charge	—	7.7	12		V _{GS} = -4.5V (see figure 6) ③
t _{d(on)}	Turn-On Delay Time	—	15	22	ns	V _{DD} = -10V
t _r	Rise Time	—	40	60		I _D = -2.9A
t _{d(off)}	Turn-Off Delay Time	—	42	63		R _G = 6.0Ω
t _f	Fall Time	—	49	73		R _D = 3.4Ω ③
C _{iss}	Input Capacitance	—	780	—	pF	V _{GS} = 0V
C _{oss}	Output Capacitance	—	470	—		V _{DS} = -15V
C _{rss}	Reverse Transfer Capacitance	—	240	—		f = 1.0MHz (see figure 5)

MOSFET Source-Drain Ratings and Characteristics

Parameter		Min.	Typ.	Max.	Units	Conditions
I _S	Continuous Source Current (Body Diode)	—	—	-2.5	A	
I _{SM}	Pulsed Source Current (Body Diode)	—	—	-21		
V _{SD}	Body Diode Forward Voltage	—	—	-1.2	V	T _J = 25°C, I _S = -2.9A, V _{GS} = 0V
t _{rr}	Reverse Recovery Time (Body Diode)	—	47	71	ns	T _J = 25°C, I _F = -2.9A
Q _{rr}	Reverse Recovery Charge	—	49	73	nC	di/dt = 100A/μs ③

Schottky Diode Maximum Ratings

	Parameter	Max.	Units	Conditions
I _{F(av)}	Max. Average Forward Current	2.7	A	50% Duty Cycle. Rectangular Wave, T _A = 25°C
		2		See Fig. 14 T _A = 70°C
I _{SM}	Max. peak one cycle Non-repetitive Surge current	120	A	5μs sine or 3μs Rect. pulse
		11		10ms sine or 6ms Rect. pulse
				Following any rated load condition & with V _{RSM} applied

Schottky Diode Electrical Specifications

	Parameter	Max.	Units	Conditions
V _{FM}	Max. Forward voltage drop	0.50	V	I _F = 1.0A, T _J = 25°C
		0.62		I _F = 2.0A, T _J = 25°C
		0.39		I _F = 1.0A, T _J = 125°C
		0.57		I _F = 2.0A, T _J = 125°C .
I _{RM}	Max. Reverse Leakage current	0.02	mA	V _R = 20V T _J = 25°C
		8		T _J = 125°C
C _t	Max. Junction Capacitance	92	pF	V _R = 5Vdc (100kHz to 1 MHz) 25°C
dv/dt	Max. Voltage Rate of Charge	3600	V/ μs	Rated V _R

Power Mosfet Characteristics

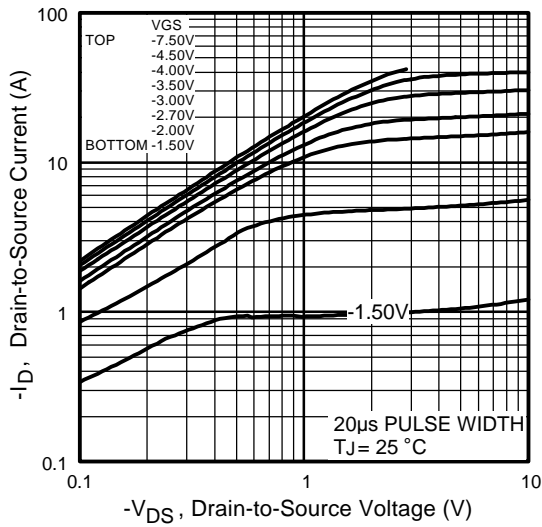

Fig 1. Typical Output Characteristics

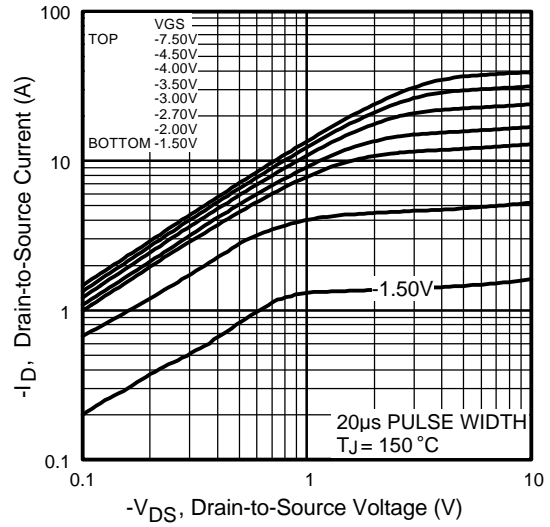

Fig 2. Typical Output Characteristics

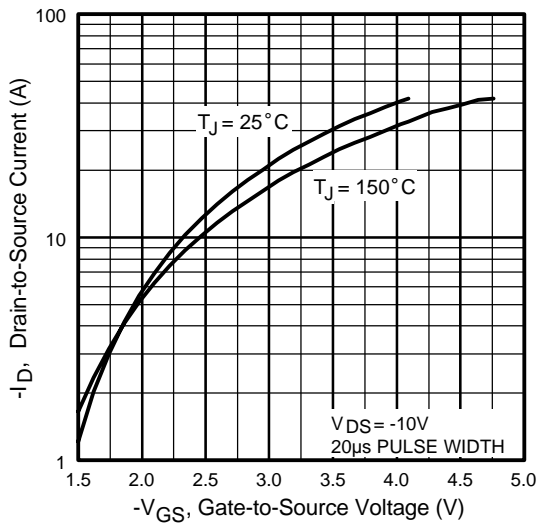

Fig 3. Typical Transfer Characteristics

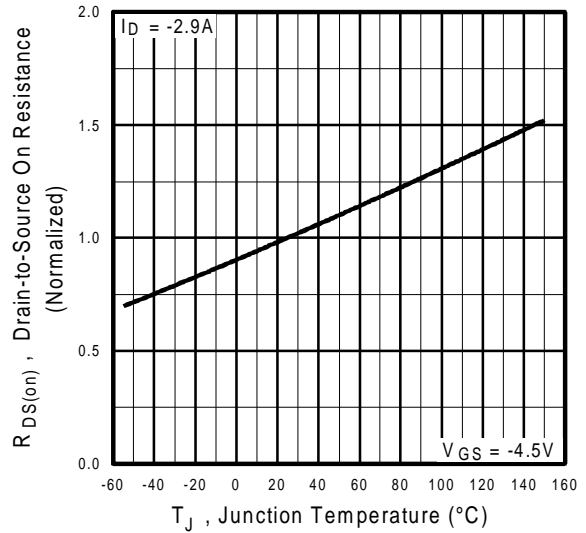

Fig 4. Normalized On-Resistance Vs. Temperature

Power Mosfet Characteristics

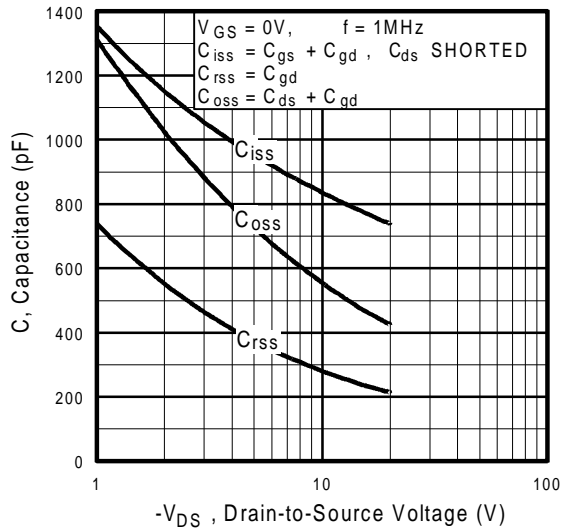

Fig 5. Typical Capacitance Vs. Drain-to-Source Voltage

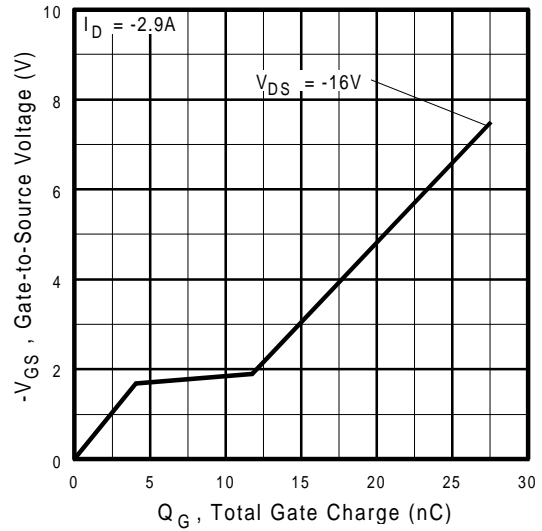

Fig 6. Typical Gate Charge Vs. Gate-to-Source Voltage

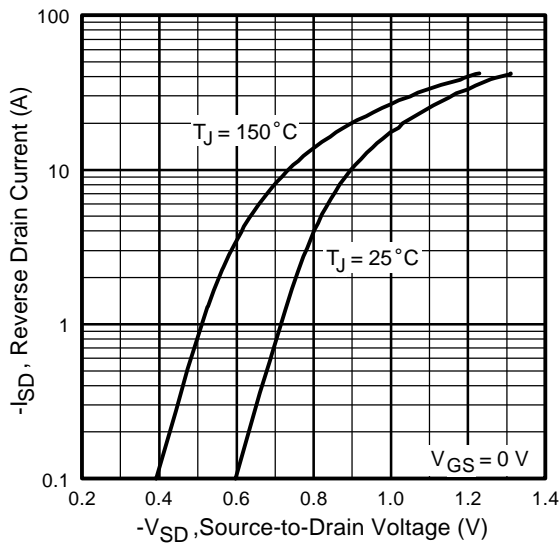

Fig 7. Typical Source-Drain Diode Forward Voltage

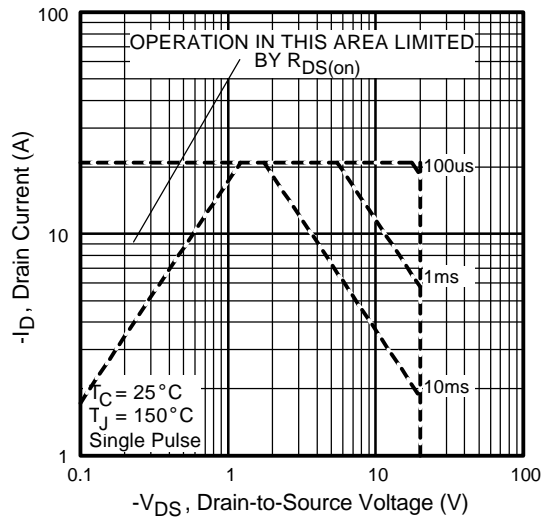

Fig 8. Maximum Safe Operating Area

Power Mosfet Characteristics

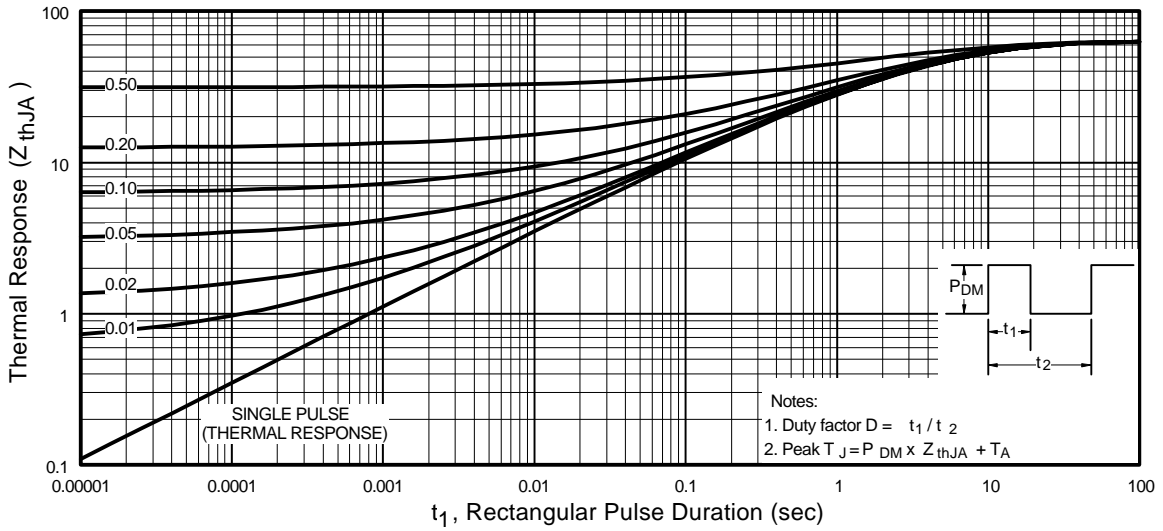

Fig 9. Maximum Effective Transient Thermal Impedance, Junction-to-Ambient

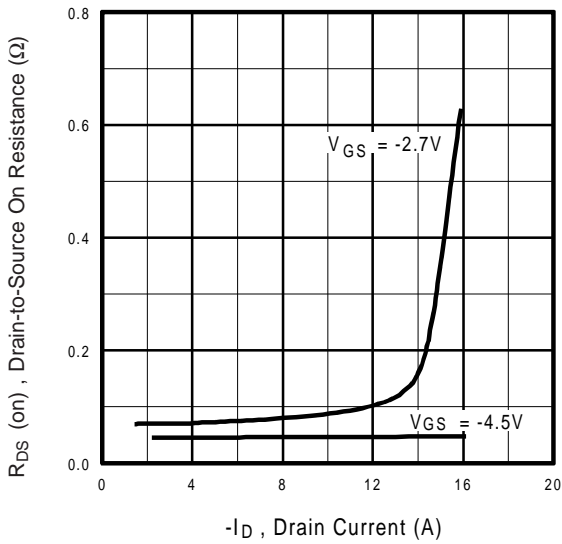

Fig 10. Typical On-Resistance Vs. Drain Current

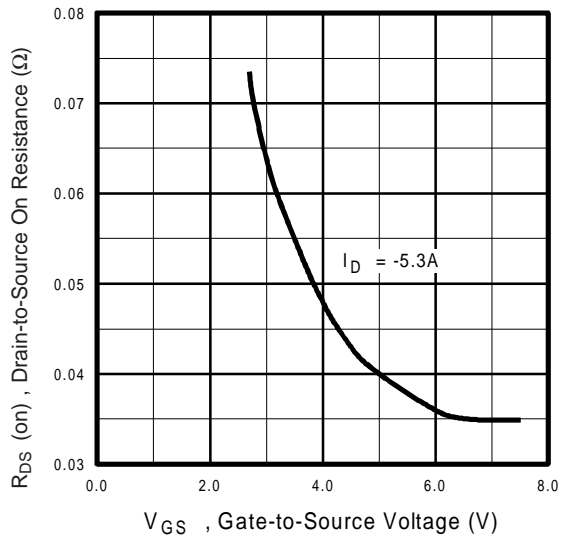

Fig 11. Typical On-Resistance Vs. Gate Voltage

Schottky Diode Characteristics

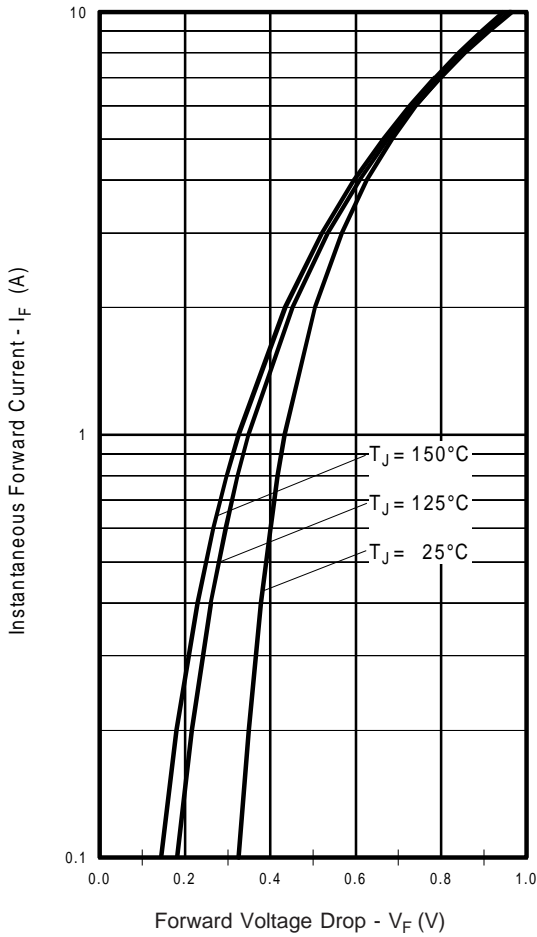

Fig. 12 - Typical Forward Voltage Drop Characteristics

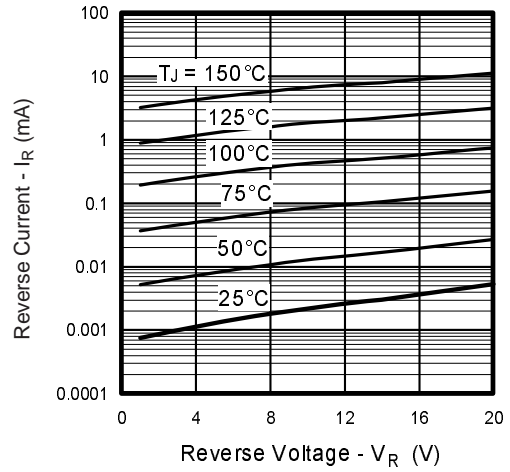

Fig. 13 - Typical Values of Reverse Current Vs. Reverse Voltage

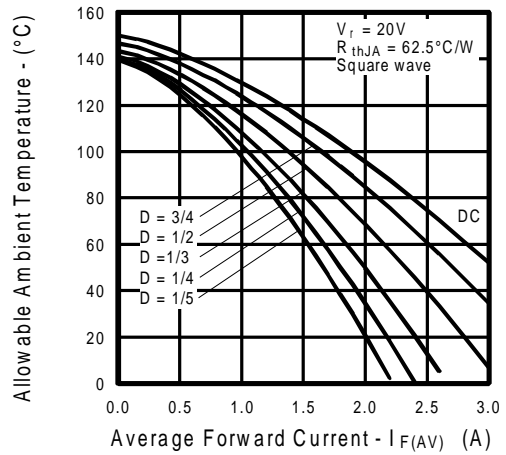
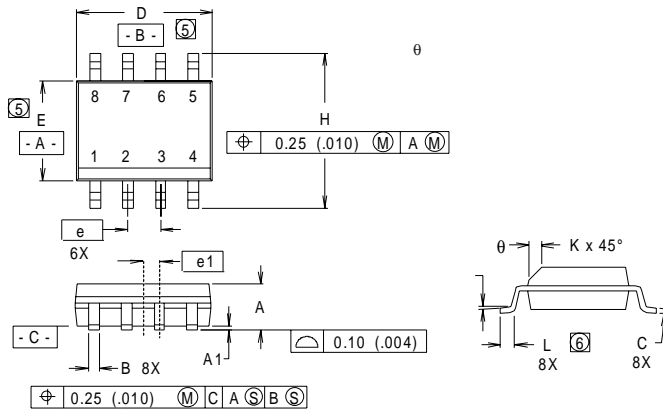

Fig.14 - Maximum Allowable Ambient Temp. Vs. Forward Current

SO-8 Package Details



DIM	INCHES		MILLIMETERS	
	MIN	MAX	MIN	MAX
A	.0532	.0688	1.35	1.75
A1	.0040	.0098	0.10	0.25
B	.014	.018	0.36	0.46
C	.0075	.0098	0.19	0.25
D	.189	.196	4.80	4.98
E	.150	.157	3.81	3.99
e	.050 BASIC		1.27 BASIC	
e1	.025 BASIC		0.635 BASIC	
H	.2284	.2440	5.80	6.20
K	.011	.019	0.28	0.48
L	0.16	.050	0.41	1.27
θ	0°	8°	0°	8°

RECOMMENDED FOOTPRINT

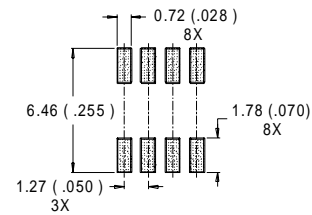

NOTES:

1. DIMENSIONING AND TOLERANCING PER ANSI Y14.5M-1982.
2. CONTROLLING DIMENSION : INCH.
3. DIMENSIONS ARE SHOWN IN MILLIMETERS (INCHES).
4. OUTLINE CONFORMS TO JEDEC OUTLINE MS-012AA.
- ⑤ DIMENSION DOES NOT INCLUDE MOLD PROTRUSIONS
MOLD PROTRUSIONS NOT TO EXCEED 0.25 (.006).
- ⑥ DIMENSIONS IS THE LENGTH OF LEAD FOR SOLDERING TO A SUBSTRATE..

Part Marking

EXAMPLE: THIS IS AN IRF7101

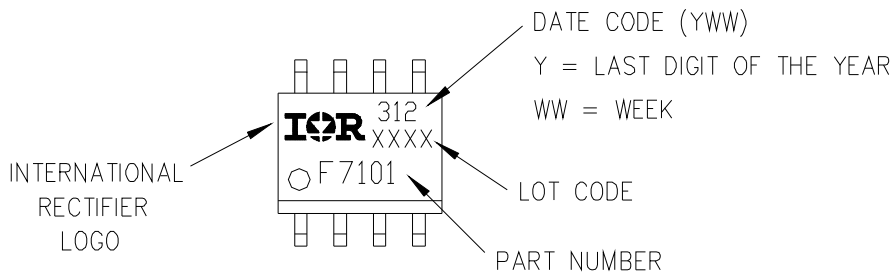

IRF7322D1

International
IR Rectifier

Tape and Reel

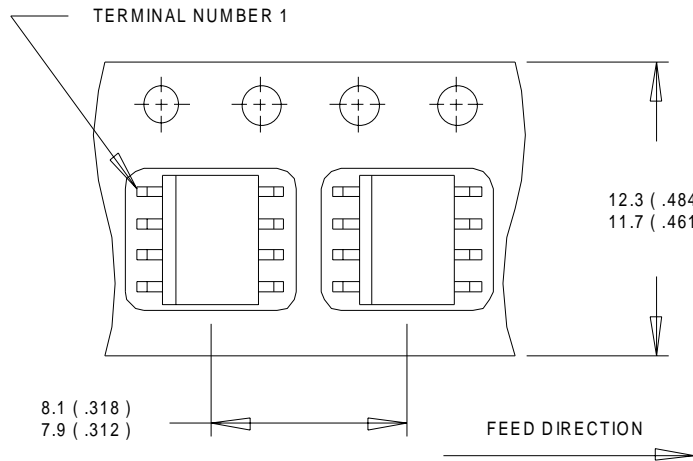

NOTES:

1. CONTROLLING DIMENSION : MILLIMETER.
2. ALL DIMENSIONS ARE SHOWN IN MILLIMETERS(INCHES).
3. OUTLINE CONFORMS TO EIA-481 & EIA-541.

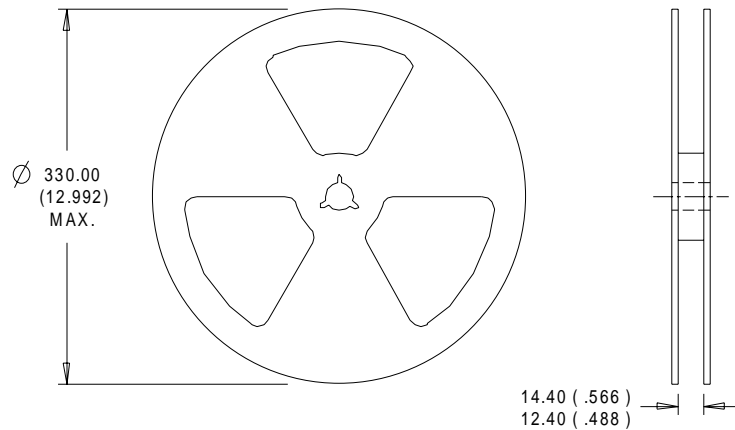

NOTES :

1. CONTROLLING DIMENSION : MILLIMETER.
2. OUTLINE CONFORMS TO EIA-481 & EIA-541.

International
IR Rectifier

WORLD HEADQUARTERS: 233 Kansas St., El Segundo, California 90245, Tel: (310) 322 3331

IR GREAT BRITAIN: Hurst Green, Oxted, Surrey RH8 9BB, UK Tel: ++ 44 1883 732020

IR CANADA: 15 Lincoln Court, Brampton, Ontario L6T3Z2, Tel: (905) 453 2200

IR GERMANY: Saalburgstrasse 157, 61350 Bad Homburg Tel: ++ 49 6172 96590

IR ITALY: Via Liguria 49, 10071 Borgaro, Torino Tel: ++ 39 11 451 0111

IR FAR EAST: K&H Bldg., 2F, 30-4 Nishi-Ikebukuro 3-Chome, Toshima-Ku, Tokyo Japan 171 Tel: 81 3 3983 0086

IR SOUTHEAST ASIA: 1 Kim Seng Promenade, Great World City West Tower, 13-11, Singapore 237994 Tel: ++ 65 221 8371

IR TAIWAN: 16 Fl. Suite D. 207, Sec. 2, Tun Haw South Road, Taipei, 10673, Taiwan Tel: 886-2-2377-9936

<http://www.irf.com/> Data and specifications subject to change without notice . 3/99