

Ok! Semiconductor

MBF93xx

Surface Acoustic Wave (SAW) Filters

DESCRIPTION

The new MBF93xx Surface Acoustic Wave (SAW) filters utilize OKI's third generation design and manufacturing technology to achieve a high out of band attenuation, low insertion loss, and low manufacturing cost in an industry standard 6-pin package 1.6 mm thick and 3.8 mm square.

These 50Ω matched bandpass microwave RF filters are designed for the worldwide standard wireless voice and data communications frequencies being utilized by cellular and wireless local-loop service providers. They have achieved design acceptance by leading wireless handset manufacturers in North America, Europe, and Asia.

OKI's lowest insertion loss SAW filters and high performance GaAs devices are used to reduce transmitter complexity. Receiver designs can be simplified by using the higher Tx frequency attenuation SAW filters.

These devices take advantage of OKI's over 15 year RF communications component manufacturing experience and very high volume manufacturing capability to meet true customer demands.

FEATURES

- Low insertion loss
- Small size, light weight
- 50Ω matched
- 6-pin SMD package
- High reliability

SAW Filter Summary^[1]

Part Number	Description	Pass Frequency	Insertion Loss	Stop Frequency	Attenuation
MBF9311	CDMA, AMPS, & TDMA Receive filter for North America standards	869-894 MHz	< 3.0 dB	824-849 MHz	> 35 dB
MBF9317	CDMA, AMPS, & TDMA Transmit filter for North America standards	824-849 MHz	< 3.5 dB	869-894 MHz	> 30 dB
MBF9321	GSM Transmit filter for European standards	890-915 MHz	< 3.5 dB	935-980 MHz	> 20 dB
MBF9323	GSM Receive filter for European standards	935-960 MHz	< 4.0 dB	890-915 MHz	> 20 dB
MBF9332	ETACS Receive filter for world wide ETACS standard	917-950 MHz	< 5.0 dB	872-900 MHz	> 25 dB
MBF9341	PCS, CDMA, & TDMA Transmit filter for North America standards	1850-1910 MHz	< 4.0 dB	1930-1990 MHz	> 25 dB
MBF9362	PCS, CDMA, & TDMA Receive filter for North America standards	1930-1990 MHz	< 4.0 dB	1850-1910 MHz	> 25 dB

1. All parts in 6-pin ceramic square package (3.8mm x 3.8mm) by 1.6 mm thick with system matched 50Ω I/O

PIN CONFIGURATION

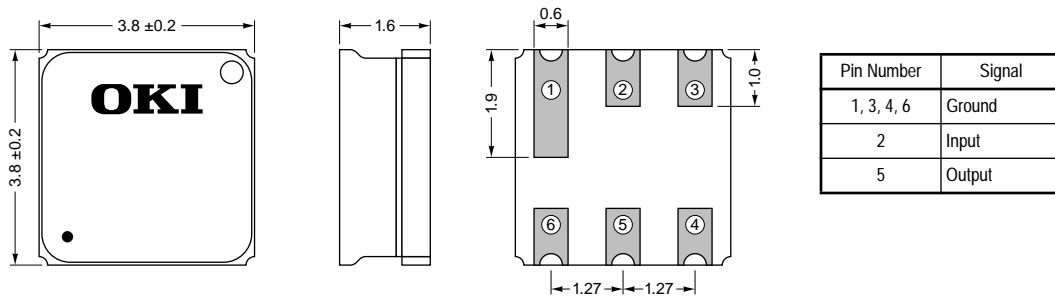

BLOCK DIAGRAM

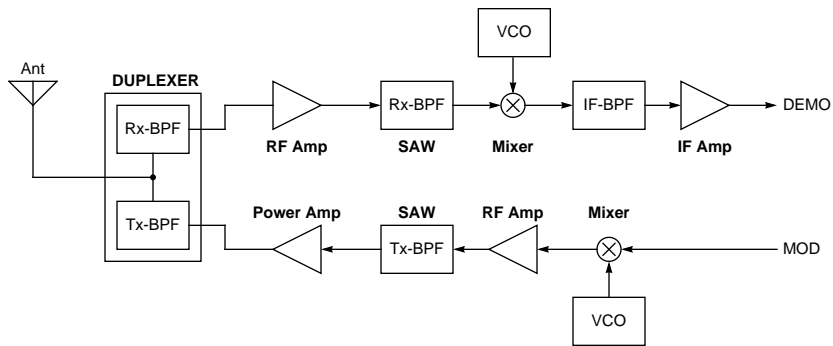

MBF9311 Electrical Characteristics (-30 ~ +85 °C)

Parameter	Frequency (MHz)	Min	Max	Units
Center Frequency (F _C)	Fr 881.5	-	-	MHz
Bandwidth (BW)	Fr ±12.5	-	-	MHz
Insertion Loss across BW	869 ~ 894	-	3.0	dB
Return Loss across BW		10	-	dB
Stop Band Attenuation	0.3 ~ 824	20	-	dB
	824 ~ 849	35	-	dB
	979 ~ 1004	25	-	dB
	1008 ~ 1114	20	-	dB

Terminating Impedance = 50 Ω

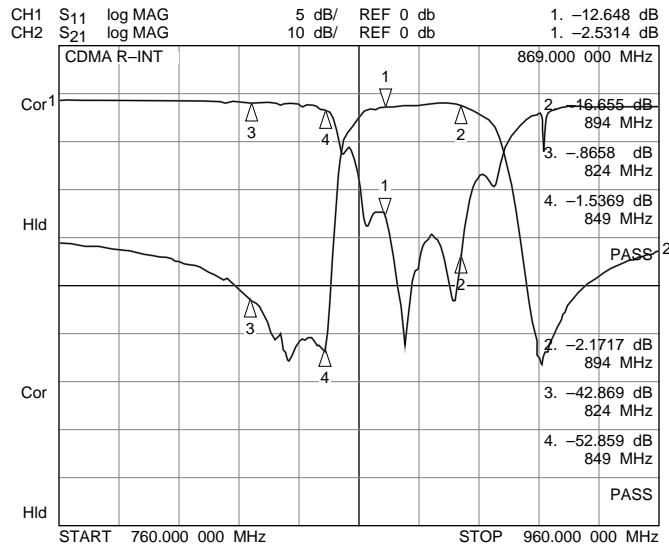

Figure 1. MBF9311 Frequency Response

MBF9317 Electrical Characteristics (-30 ~ +85 °C)

Parameter	Frequency (MHz)	Min	Max	Units
Center Frequency (F _C)	Ft 836.5	-	-	MHz
Bandwidth (BW)	Fr ±12.5	-	-	MHz
Insertion Loss across BW	824 ~ 849	-	3.5	dB
Return Loss across BW		10.0	-	dB
Stop Band Attenuation	0.3 ~ 800	28	-	dB
	869 ~ 1049	30	-	dB
	1049 ~ 2000	25	-	dB

Terminating Impedance = 50 Ω

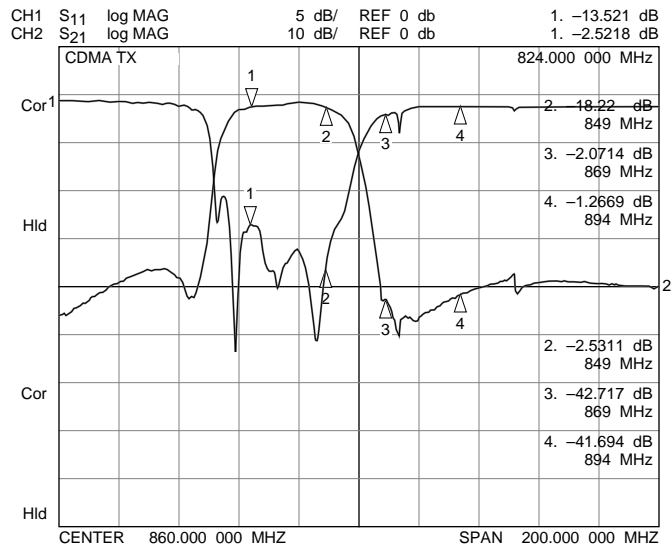

Figure 2. MBF9317 Frequency Response

MBF9321 Electrical Characteristics (-30 ~ +85 °C)

Parameter	Frequency (MHz)	Min	Max	Units
Center Frequency (F _C)	902.5	-	-	MHz
Bandwidth (BW)	Ft ±12.5	-	-	MHz
Insertion Loss across BW	890 ~ 915	-	3.5	dB
Ripple across BW		-	2.0	dB
VSWR across BW		-	2.5	-
Stop Band Attenuation	500 ~ 870	20	-	dB
	935 ~ 980	20	-	dB
	980 ~ 1100	26	-	dB
	1100 ~ 1500	15	-	dB

Terminating Impedance = 50 Ω

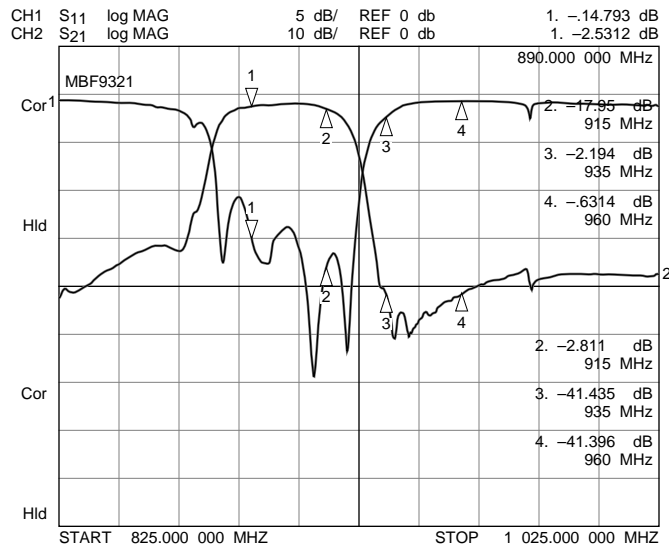

Figure 3. MBF9321 Frequency Response

MBF9323 Electrical Characteristics (-30 ~ +85 °C)

Parameter	Frequency (MHz)	Min	Max	Units
Center Frequency (F _C)	947.5	-	-	MHz
Bandwidth (BW)	Ft ±12.5	-	-	MHz
Insertion Loss across BW	935 ~ 960	-	3.5	dB
Ripple across BW		-	2.0	dB
VSWR across BW		-	2.5	-
Stop Band Attenuation	500 ~ 870	30	-	dB
	890 ~ 915	20	-	dB
	980 ~ 1025	15	-	dB
	1025 ~ 1070	33	-	dB
	1070 ~ 1105	30	-	dB
	1105 ~ 1500	20	-	dB

Terminating Impedance = 50 Ω

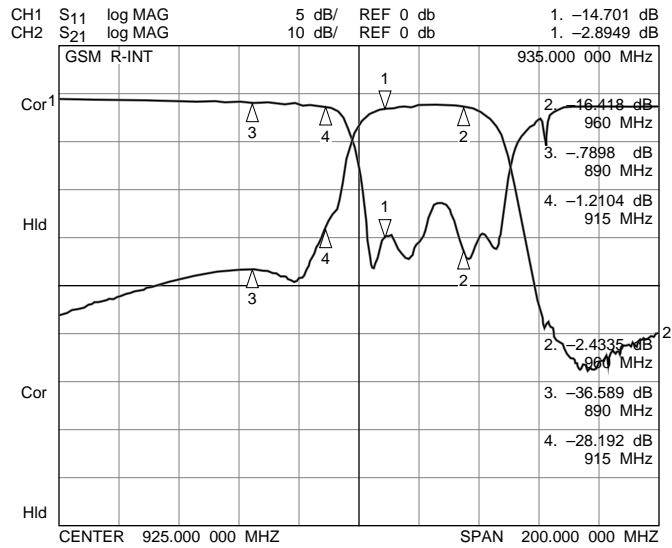

Figure 4. MBF9323 Frequency Response

MBF9332 Electrical Characteristics (-30 ~ +85 °C)

Parameter	Frequency (MHz)	Min	Max	Units
Center Frequency (F _C)	933.5	-	-	MHz
Bandwidth (BW)	Ft ±16.5	-	-	MHz
Insertion Loss across BW	917 ~ 950	-	5.5	dB
VSWR across BW		-	2.0	-
Stop Band Attenuation	0 ~ 872	20	-	dB
	872 ~ 900	25	-	dB
	900 ~ 905	10	-	dB
	1007 ~ 1040	30	-	dB
Output Reflection Coefficient	1031~1065	Mag	0.86	Degrees
		Angle	-155	-125

Terminating Impedance = 50 Ω

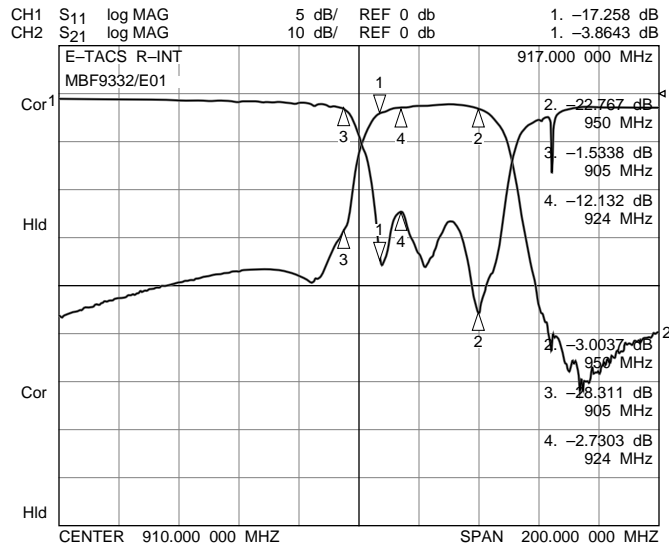

Figure 5. MBF9332 Frequency Response

MBF9341 Electrical Characteristics (-30 ~ +85 °C)

Parameter	Frequency (MHz)	Min	Typ	Max	Units
Center Frequency (F _C)	1880	-	-	-	MHz
Bandwidth (BW)	Ft ±30	-	-	-	MHz
Insertion Loss across BW	1850-1910	-	-	5.0	dB
Ripple across BW		-	2.0	-	dB
VSWR across BW		-	-	2.0	-
Stop Band Attenuation	1590 ~ 1650	18	-	-	dB
	1720 ~ 1780	16	-	-	dB
	1930 ~ 1990	7	14	-	dB

Terminating Impedance = 50 Ω

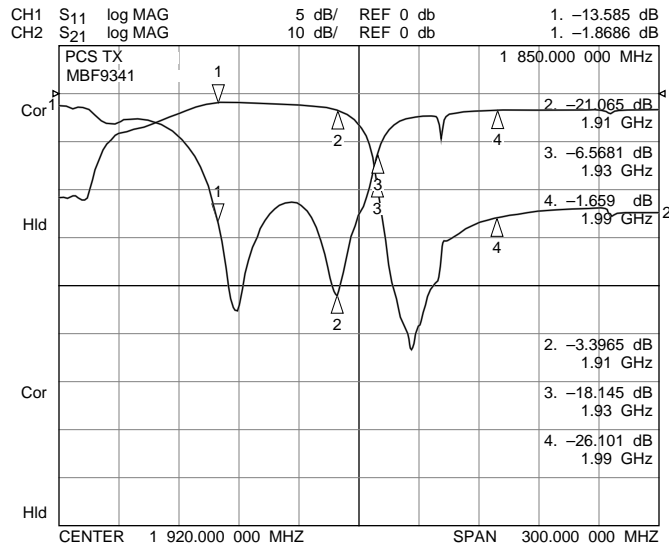

Figure 6. MBF9341 Frequency Response

MBF9362 Electrical Characteristics (-30 ~ +85 °C)

Parameter	Frequency (MHz)	Min	Typ	Max	Units
Center Frequency (F _C)	Fr: 1960				MHz
Bandwidth (BW)	Fr± 30				MHz
Insertion Loss across BW	1930 ~ 1990	-	-	5.0	dB
Ripple across BW		-	2.0	3.0	dB
VSWR across BW		-	-	2.0	-
Stop Band Attenuation	1509 ~ 1570	20	-	-	dB
	1720 ~ 1780	20	-	-	dB
	1850 ~ 1910	13	26	-	dB

Terminating Impedance = 50 Ω

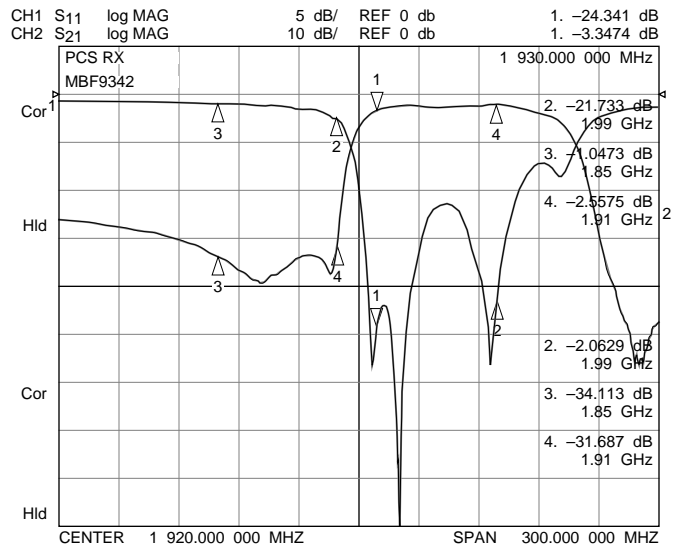

Figure 7. MBF9362 Frequency Response

The information contained herein can change without notice owing to product and/or technical improvements.

Please make sure before using the product that the information you are referring to is up-to-date.

The outline of action and examples of application circuits described herein have been chosen as an explanation of the standard action and performance of the product. When you actually plan to use the product, please ensure that the outside conditions are reflected in the actual circuit and assembly designs.

OKI assumes no responsibility or liability whatsoever for any failure or unusual or unexpected operation resulting from misuse, neglect, improper installation, repair, alteration or accident, improper handling, or unusual physical or electrical stress including, but not limited to, exposure to parameters outside the specified maximum ratings or operation outside the specified operating range.

Neither indemnity against nor license of a third party's industrial and intellectual property right, etc. is granted by us in connection with the use of product and/or the information and drawings contained herein. No responsibility is assumed by us for any infringement of a third party's right which may result from the use thereof.

When designing your product, please use our product below the specified maximum ratings and within the specified operating ranges, including but not limited to operating voltage, power dissipation, and operating temperature.

The products listed in this document are intended for use in general electronics equipment for commercial applications (e.g., office automation, communication equipment, measurement equipment, consumer electronics, etc.). These products are not authorized for use in any system or application that requires special or enhanced quality and reliability characteristics nor in any system or application where the failure of such system or application may result in the loss or damage of property or death or injury to humans. Such applications include, but are not limited to: traffic control, automotive, safety, aerospace, nuclear power control, and medical, including life support and maintenance.

Certain parts in this document may need governmental approval before they can be exported to certain countries. The purchaser assumes the responsibility of determining the legality of export of these parts and will take appropriate and necessary steps, at their own expense, for export to another country.

Copyright 1997 OKI SEMICONDUCTOR

OKI Semiconductor reserves the right to make changes in specifications at anytime and without notice. This information furnished by OKI Semiconductor in this publication is believed to be accurate and reliable. However, no responsibility is assumed by OKI Semiconductor for its use; nor for any infringements of patents or other rights of third parties resulting from its use. No license is granted under any patents or patent rights of OKI.

OKI SEMICONDUCTOR